

# TILING TOOLS & ACCESSORIES

PREPARE

CUT

SHAPE

FIX

FINISH

**NEW  
PRODUCTS  
INSIDE**



# ABOUT US

1939

Established in 1939 by Gaston Florin, Vitrex initially developed a range of hand tools during World War 2. The first plastic DIY products to be sold under the Vitrex brand were launched during the 1950's, and continued growth through the 1970's and early 1980's established Vitrex as a leading brand in the emerging DIY consumer market.

**Vitrex**<sup>®</sup>   
Sign of a **professional** job

2004

Vitrex was acquired by Q.E.P. in 2004 and as part of a leading worldwide manufacturer and supplier of tiling equipment, flooring, tools & accessories, Vitrex is now better placed than ever to fulfil its long standing aim to design, manufacture and distribute professional quality products at affordable prices – for both the keen DIY-er and the professional user.



80 years

Today Vitrex is an established and recognised supplier to the very best home centres and distributors in the UK and has been at the forefront of the home improvement market for 80 years.

# CONTENTS

## ELECTRIC TILE CUTTERS

FROM PAGE 4

## MANUAL TILE CUTTERS

FROM PAGE 13

## MIXERS

FROM PAGE 19

## PREPARATION

FROM PAGE 22

## CUTTING

FROM PAGE 26

## SHAPING

FROM PAGE 34

## FIXING

FROM PAGE 37

## FINISHING

FROM PAGE 45

## TILE CARE

FROM PAGE 52

## ANCILLARIES/KITS

FROM PAGE 57





# Electric Tile Cutters





**VERSATILE POWER PRO 900 BRIDGE SAW**

- Fully adjustable angle guide for diagonal tile cuts from 0–45 degrees
- Direct drive motor has a thermal overload protection to prevent overheating and produces constant cutting speed for ultra smooth cuts
- Oversized ‘bench style’ slotted aluminium cutting table with integral drainage
- Sliding ruler and locking mitre guide for perfect straight cuts
- Dual water feed increases blade life
- Sturdy folding leg supports and detachable lower shelf
- Large water tray with submersible pump which delivers water to cutting wheel for essential cooling
- Convenient built-in carry handles and adjustable wheels for easy repositioning and transporting between jobs

ALSO AVAILABLE IN

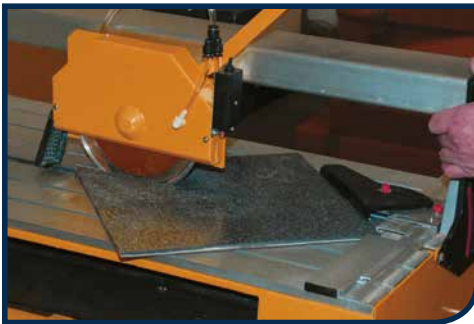

**WATER PUMP TECHNOLOGY DELIVERS WATER DIRECTLY TO THE BLADE**



610mm



435mm



35mm

**Straight, Angle & Mitre Cuts...**



**Straight Cuts**

**Profile Cuts**

**Irregular Angles**

**Including 45°**

**45° Mitre Cuts**

**Tile Types...**



230 Volt
Item No.
103450

110 Volt
Item No.
103440

SPARE PARTS	ITEM No.
Water Tray for 103450	103453
Water Pump for 103450	103454

**POWER PRO 800**

- 800w super quiet induction motor
- Additional side table to support larger format tiles
- Dual water feed increases blade life
- Ø 200mm diamond blade with continuous rim for clean cuts
- Oversized 'dench style' slotted non slip rubber coated cutting table with integral drainage
- Sliding ruler and locking mitre guide for a diagonal tile cut from 0° - 45°

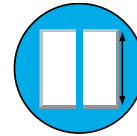

720mm

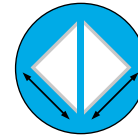

510mm

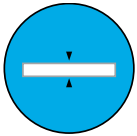

35mm



**WATER PUMP TECHNOLOGY  
DELIVERS WATER DIRECTLY  
TO THE BLADE**

**Straight, Angle & Mitre Cuts...**



**Straight  
Cuts**

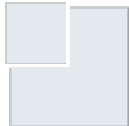

**Profile  
Cuts**



**Irregular  
Angles**



**Including  
45°**



**45°  
Mitre  
Cuts**



**Tile Types...**



230 Volt
Item No.
103490



**800W BRIDGE SAW**

- 800w super quiet induction motor
- Fully adjustable angle guide for diagonal tile cuts from 0–45 degrees
- Ø 200mm diamond blade with continuous rim for clean cuts
- Table with non-slip rubber for better grip
- Constant speed for smooth cuts
- Water tray with drain plug for easier cleaning
- Removable stand

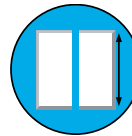

620mm

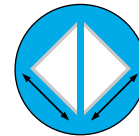

440mm

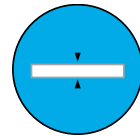

35mm



**WATER PUMP TECHNOLOGY  
DELIVERS WATER DIRECTLY  
TO THE BLADE**

**Straight, Angle & Mitre Cuts...**

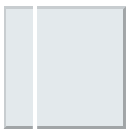

**Straight  
Cuts**

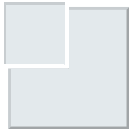

**Profile  
Cuts**



**Irregular  
Angles**



**Including  
45°**



**45°  
Mitre  
Cuts**



**Tile Types...**



230 Volt
Item No.
103620



**VERSATILE POWER PRO 750 WET SAW**

750W

ALSO AVAILABLE IN



- Direct drive produces a constant cutting speed for ultra smooth cuts
- Automatic overload protection to prevent overheating
- Ø180 x 16mm diamond blade with continuous rim for extra clean cuts
- Extra large cast aluminium cutting table for supporting large format tiles
- Cutting table tilts for 15°, 30° and 45° mitres
- Fully adjustable mitre guide for cutting tiles to any angle
- Water cooling system with large reservoir and integral drainage
- Transparent wheel guard with variable height adjustment
- Moulded plug with 1.5m cable
- Convenient built-in carry handle and cable tidy
- Black carrier is reversible for both 16mm and 22mm bore sizes

180MM  
BLADE



**Straight, Angle & Mitre Cuts...**

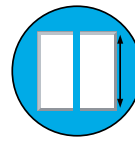
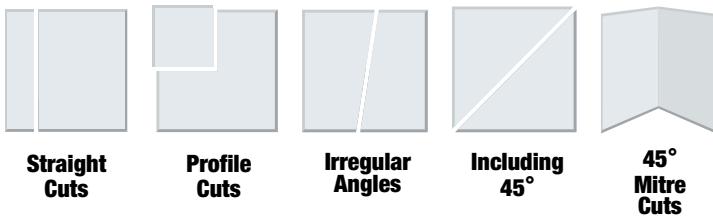

All

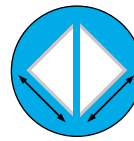

All

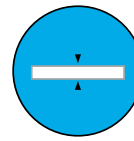

25mm

230 Volt	
Item No.	103420
110 Volt	
Item No.	103421

SPARE PARTS	ITEM No.
Replacement Blade Guard	1420BG
Replacement Rip Guide	1420ML



**ASTRO 720W WET SAW CUTTER**



- Cuts tiles and masonry up to 43mm thick
- 200mm turbo diamond blade for dry cuts recommended for brick and concrete
- 200mm continuous rim diamond blade for wet cuts recommended for tiles
- Stainless steel surface
- Extension table to support large format tiles
- Tilting surface for 0-45° mitres
- Water cooling system
- Storage case for easy transportation

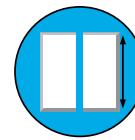
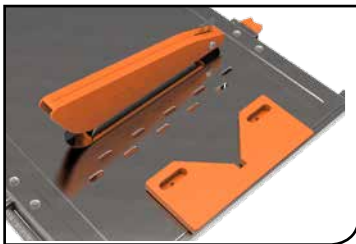

All

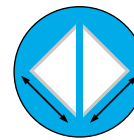

All

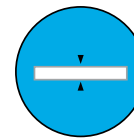

43mm

230 Volt	
Item No.	WSBMC720

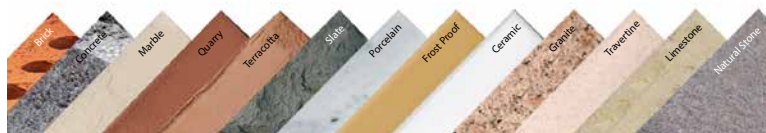

**VERSATILE**

**POWER PRO 650 WET SAW**

650W

180MM  
BLADE

- Powerful motor for maximum cutting performance
- Splash guard with variable height adjustment
- Ø180mm diamond blade with continuous rim for extra clean cut
- Mitre guide
- Double extension tables for larger format tiles
- Integral measuring guide and quick release rip guide for perfect straight cuts
- Flip-up cutting table for 22.5° and 45° mitres
- 'No mess' water re-circulation system
- Quick release splash guard for plunge cuts



**Straight, Angle, Mitre & Plunge Cuts...**



**Straight Cuts**

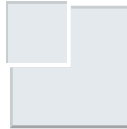

**Profile Cuts**



**Irregular Angles**



**Including 45°**



**45° Mitre Cuts**

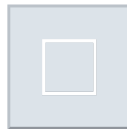

**Plunge Cuts**

230 Volt
Item No.
103430

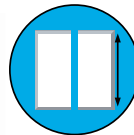

All

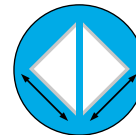

All

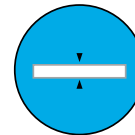

30mm

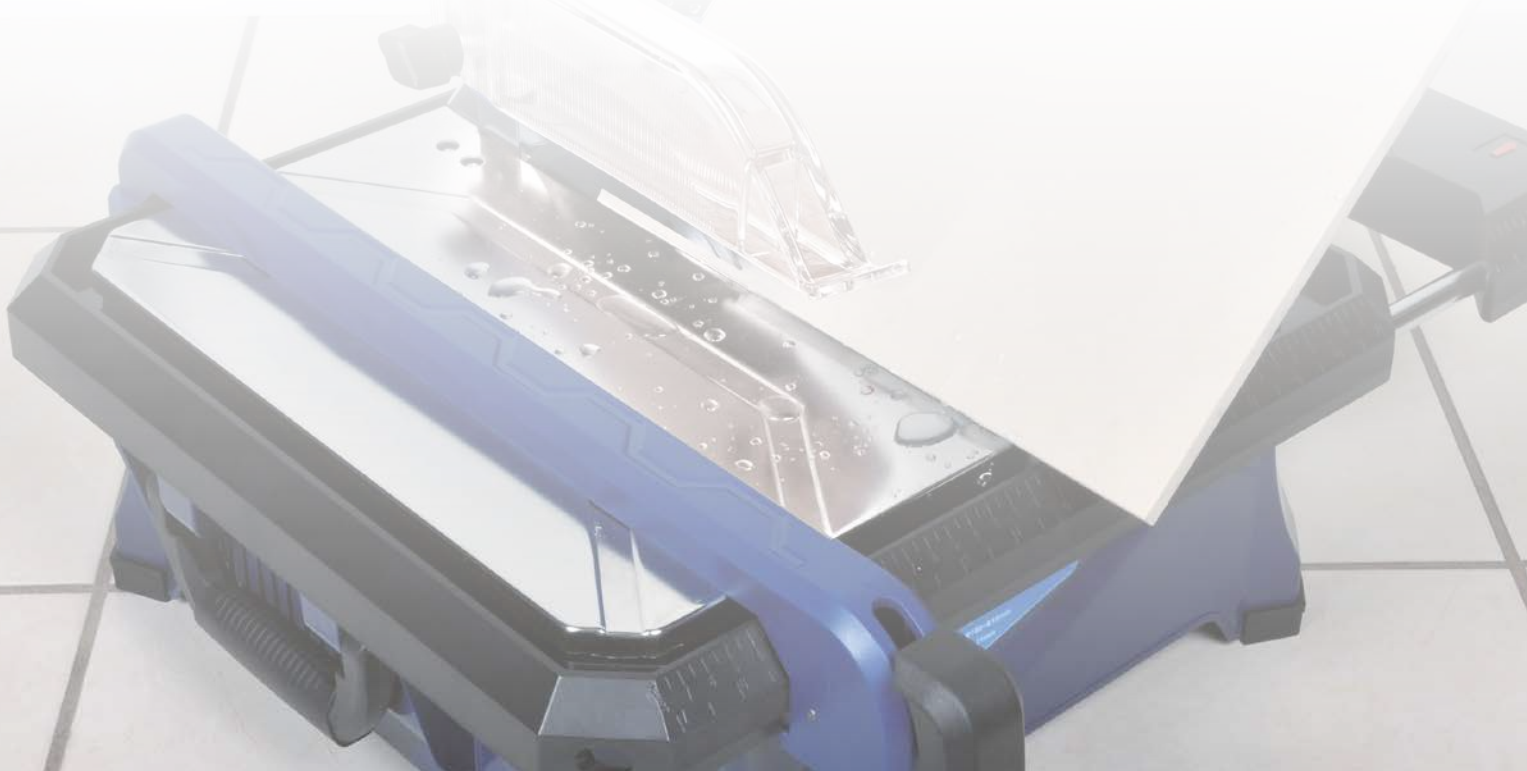



**VERSATILE**

**POWER MAX 560 WET SAW**

- 560w Hi-Torque direct drive motor for efficient cutting
- Adjustable double extension arms to support larger format tiles
- Ø180mm continuous rim diamond blade
- Cutting table tilts for 0° - 45° mitre cuts
- Mitre guide for cutting tiles to any angle
- Water cooling system with water re-circulation
- Quick release splash guard for plunge cuts



230 Volt
Item No.
WS560180

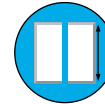

ALL

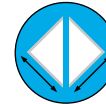

ALL

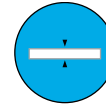

25mm



**DOUBLE  
EXTENSION  
TABLES FOR  
LARGER  
FORMAT TILES**



SPARE PARTS	ITEM No.
Replacement Mitre Guard	1405MG
Replacement Blade guard	1402BG



**Straight  
Cuts**

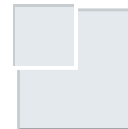

**Profile  
Cuts**



**Irregular  
Angles**



**Including  
45°**



**45°  
Mitre  
Cuts**

**TORQUE-MASTER POWER COMPACT**

- Hi-Torque geared motor for maximum cutting performance
- Splash guard with variable height adjustment
- Ø110mm diamond blade with continuous rim for extra clean cut
- Fully adjustable mitre guide with unique ratchet mechanism
- Integral measuring guide and quick release rip guide for perfect straight cuts
- Flip-up cutting table for 22.5° and 45° mitres
- 'No mess' water re-circulation system
- Quick release splash guard for plunge cuts



ALL

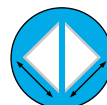

ALL

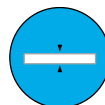

25mm



**DOUBLE  
EXTENSION  
TABLES FOR  
LARGER FORMAT  
TILES**



**Straight  
Cuts**

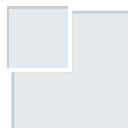

**Profile  
Cuts**



**Irregular  
Angles**



**Including  
45°**



**45°  
Mitre Cuts**

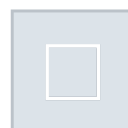

**Plunge  
Cuts**

230 Volt
Item No.
103402NDE



SPARE PARTS	ITEM No.
Replacement Mitre Guard	1405MG
Replacement Rip Guide	1405RG
Replacement Blade Guide	1405BG



**ANGLE GRINDER**

- For cutting & grinding of metal, ceramic, stone & concrete
- Supplied with 115mm grinding disc & grinding guard
- Includes 115mm dry cut diamond disc & cutting guard ideal for large format tiles
- Includes carry case for easy storage

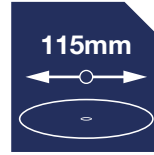

230 Volt
Item No.
AGR900



- Quick release lever on guards
- Spindle lock for easy disc change
- 3 position side handle

**INCLUDES**  
Dry Cut  
Diamond  
Disc



**REPLACEMENT BLADES**

**Chip Free Cutting!**  
**Exclusive blade design**  
**for minimal vibration**  
**and no chipping**

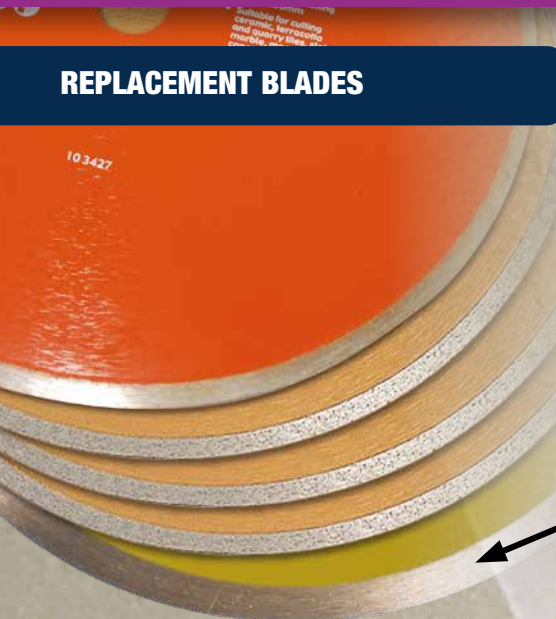

STANDARD	HI-GLAZE	GLASS	ULTIMATE
Suitable for cutting ceramic, terracotta and quarry tiles, slate, marble, masonry, concrete and stone	For wet or dry cutting of ceramic, porcelain and marble tile	For the wet cutting of glass tiles, rim height 7mm	More diamonds than standard blades for a longer blade life and finer, more accurate cuts
Standard	Hi-Glaze	Glass	Ultimate

Item	Description	Size	BT65011	WS560180	103402NDE	103420/21	103430	103440/50	103490	103620
103409	Diamond Blade - Standard	110mm			X					
103416	Diamond Blade - Hi Glaze	110mm			X					
103417	Diamond Blade - Glass	110mm			X					
103407	Diamond Blade - Hi Glaze	180mm		X		X	X			
103406	Diamond Blade - Standard	180mm		X		X	X			
103411	Diamond Blade - Standard	200mm						X	X	X
103412	Diamond Blade - Ultimate	200mm						X	X	X
103427	Diamond Blade - Standard	250mm	X							
103428	Diamond Blade - Ultimate	250mm	X							



**All blades include a reduction spacer to allow use on either 16mm or 22mm bore**

- This amazing technology allows for precise diamond arrangement and alignment on each blade, set to control wear and make the blade cut faster.
- In some situations, this technology can increase the cutting speed by 50% while doubling a normal blades life.



# Manual Tile Cutters





**HOBBY 300 TILE CUTTER**

- Easy to use with simple 'score and snap' cutting action
- Sturdy polypropylene base with steel reinforcement and integral ruler
- Tungsten Carbide cutting wheel ø13mm with variable height adjustment

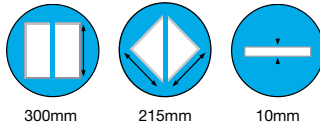

300mm

215mm

10mm

Item No.
102400



**300 MANUAL TILE CUTTER**

- Steel flat bed tile cutter with simple 'score and snap' cutting action
- Suitable for cutting wall, floor and quarry tiles up to 300mm square and 10mm thick
- Diagonal cuts possible on tiles up to 215mm square
- Includes 2 tungsten wheels ø15mm (Spare wheel stored inside handle)

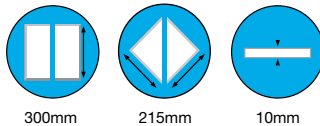

300mm

215mm

10mm

Item No.
102350

SPARE PARTS	Diameter	Item No.
Rep. cutting wheel	Ø 14mm	102335



**330 TILE CUTTER**

- Cuts wall and floor tiles up to 330mm in length & 254mm diagonally
- Equipped with a long-lasting 13mm Tungsten Carbide cutting wheel
- Dual chrome-plated heavy duty steel rails ensure smooth scoring

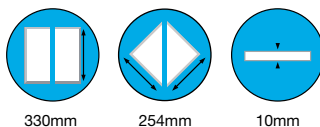

330mm

254mm

10mm

Item No.
102340

SPARE PARTS	Diameter	Item No.
Rep. cutting wheel	Ø 14mm	102335



**400 MANUAL TILE CUTTER**

- Steel flat bed tile cutter with simple 'score and snap' cutting action
- For cutting wall, floor and quarry tiles up to 400mm square and 10mm thick
- Includes 2 Tungsten Carbide cutting wheels Ø15mm (Spare wheel stored inside handle)
- Diagonal cuts possible on tiles up to 280mm square

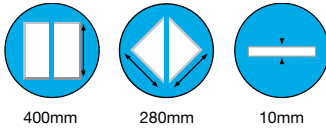

Item No.
102330

SPARE PARTS	Diameter	Item No.
Rep. cutting wheel	Ø 14mm	102335



**500 MANUAL TILE CUTTER**

- Rigid steel construction and integral angle cutting guide
- Easy to use with a simple 'score and snap' cutting operation
- Cuts ceramic wall & floor tiles up to 500mm square and 12mm thick
- Diagonal cuts also possible on tiles up to 360mm square tiles

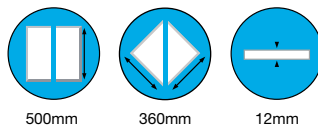

Item No.
102360

SPARE PARTS	Diameter	Item No.
Rep. cutting wheel	Ø 14mm	102335



**600 MANUAL TILE CUTTER**

- Simple 'score and snap' operation
- Tungsten carbide cutting wheel
- Straight cuts on tiles up to 600mm square
- Diagonal cuts also possible on tiles up to 425mm square tiles
- Suitable for cutting wall, floor and ceramic tiles up to 12mm thick

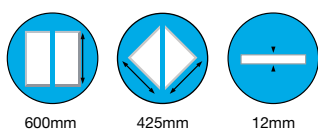

Item No.
102371

SPARE PARTS	Diameter	Item No.
Rep. cutting wheel	Ø 14mm	102335





**600MM MANUAL TILE CUTTER**

- Roller bearings for smooth scoring action
- Measuring guide for straight and angled cuts
- Extension bar for large format tiles
- Rubber handle provides a secure grip
- Folding leg supports enabling cutting at a convenient height
- Integral handle and wheels for easy transportation

Item No.
FSMC600

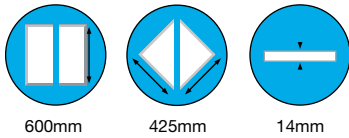

600mm      425mm      14mm



**630 HEAVY DUTY TILE CUTTER**

- Compact and lightweight, with a rigid aluminium construction and adjustable cutting guide
- Cuts tiles up to 630mm long, diagonal cuts on tiles up to 445mm square
- Suitable for cutting wall, floor and ceramic tiles up to 13mm thick
- Simple 'score and snap' operation
- Tungsten carbide cutting wheel

Item No.
102380

SPARE PARTS	Diameter	Item No.
Rep. cutting wheel	Ø 22mm	102385

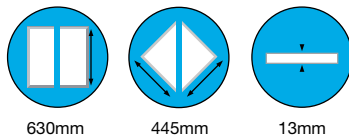

630mm      445mm      13mm



**900 HEAVY DUTY TILE CUTTER**

- Compact and lightweight, with a rigid aluminium construction and adjustable cutting guide
- Suitable for cutting wall, floor and ceramic tiles up to 13mm thick
- Simple 'score and snap' operation
- Tungsten carbide cutting wheel

Item No.
102390

SPARE PARTS	Diameter	Item No.
Rep. cutting wheel	Ø 22mm	102385

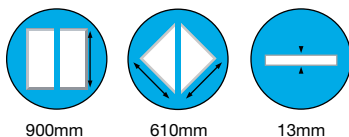

900mm      610mm      13mm





**Clinker XL 750**

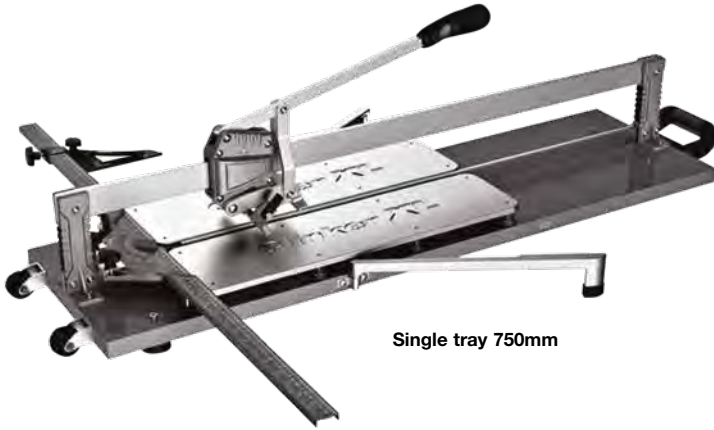

Single tray 750mm

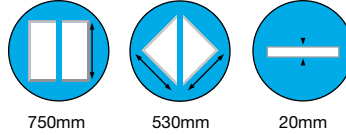

Item No.
BRUTUS750

SPARE PARTS	Item No.
Rep. cutting wheel	CXL WHEEL

**Clinker XL 900**

- High precision cutting head with replaceable tungsten carbide wheel
- Cutting head carriage with ball bearings for greater accuracy and easier use
- Table extensions to support larger format tiles
- Large graduated swivelling cutting guide
- Replacement cutting wheel available
- Comfortable co-moulded handle
- Wheels for easy transport
- Shock absorbing trays
- 2 year guarantee
- Carrying handle

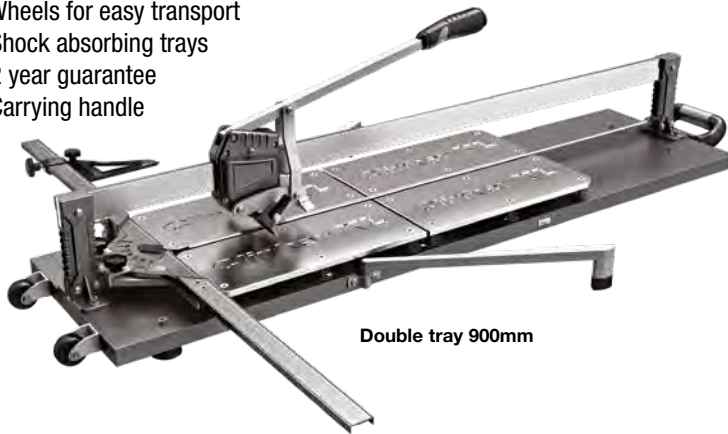

Double tray 900mm

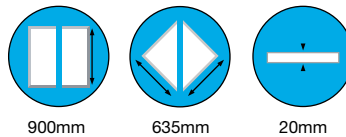

Item No.
BRUTUS900

SPARE PARTS	Item No.
Rep. cutting wheel	CXL WHEEL

**1200MM PROFESSIONAL TILE CUTTER**

- For cutting floor ceramic tiles up to 1200mm
- Professional heavy duty cutter with interior bearings for high precision
- Max cutting length 1200mm
- Cuts tiles up to 18mm thick
- Tungsten Carbide cutting wheel 22 x 10.5 x 2mm

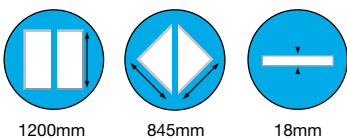
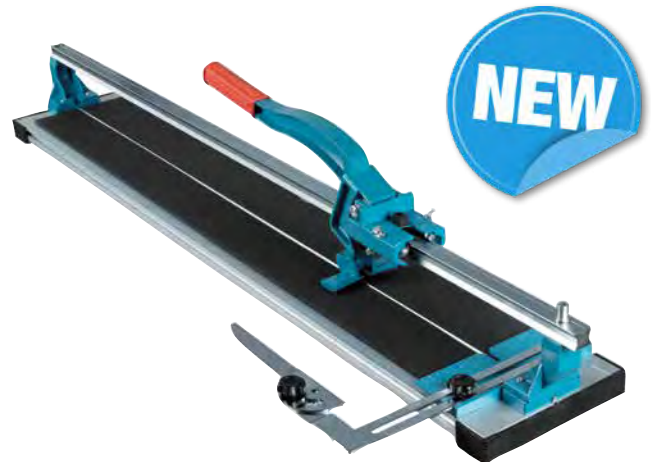

Item No.
MTC1200

SPARE PARTS	Item No.
Cutting Wheel	MTC1205









- Aluminium frame
- Cutting head carriage mounted on ball bearings
- Graduated swivel cutting guide for diagonal cut
- Spring loaded base with anti-slip mats
- Directional side stabilisers



**TOMECANIC**  
**bénétière**



**TOMECANIC SUPERCOUPE 600/750/900MM**



			Item No. T3110030
600mm	420mm	20mm	
			Item No. T3110060
750mm	530mm	20mm	
			Item No. T3110040
900mm	635mm	20mm	

**TOMECANIC SUPERCOUPE 1350MM**



			
1350mm	950mm	20mm	
Item No. T3110080	SPARE PARTS Replacement Cutting Wheel	Item No. T3260090	





# Mixers



**850W POWER MIXER**

- Lightweight for comfortable handling and carrying
- Adjustable speed control
- Lockable speed control for continuous operation
- Metal handle acts as a rest when placing down protecting the mixer head
- Easy change brushes for increased motor life and easier servicing (available separately)



ALSO AVAILABLE IN



SPECIFICATIONS	MIX850	MIX850IND
Power Supply	230v / 50Hz	110v / 50Hz
Motor	850w	850w
No. of Gears	1	1
Speed (no load)	0-550 rpm	0-550 rpm
Mixing Paddle	Ø120mm	Ø120mm



SPARE PARTS	Power	Item No.
Carbon Brush for MIX850	230v	BRUSH850
Carbon Brush for MIX850/I	110v	BRUSH850/I

**1400W POWER MIXER - TWIN GEAR**

- Specially designed powerful motors
- 2 gears for high performance
- Electronically controlled variable speed
- Lockable speed control for continuous operation
- Supplied in storage case

ALSO AVAILABLE IN



SPECIFICATIONS	MIX1400	MIX1400IND
Power Supply	230v / 50Hz	110v / 50Hz
Motor	1400w	1400w
No. of Gears	2	2
Speed (no load)	300-700 rpm	300-700 rpm
Mixing Paddle	Ø140mm	Ø140mm



SPARE PARTS	Power	Item No.
Carbon Brush for MIX1400	230v	BRUSH1400
Carbon Brush for MIX1400/I	110v	BRUSH1400/I



**1600W POWER MIXER**

- Powerful high torque motor for more efficient mixing
- Ergonomic handle to minimise fatigue
- Variable speed for greater control
- Safety on/off switch with lock-on function for continuous running
- Thermal overload protection for increased safety
- 140mm mixing paddle - mixes up to 120L
- Robust carry case for ease of transportation



SPECIFICATIONS	MIXPLUS	MIXPLUSIND
Power Supply	230v / 50Hz	110v / 50Hz
Motor	1600w	1400w
No. of Gears	2	2
Speed (no load)	180-460/300-750 rpm	180-460/300-750 rpm
Mixing Paddle	Ø140mm	Ø140mm



**MIXER STAND AND BUCKET**



- Stand suitable for use with Vitrex Mixers
- Height 745mm
- Diameter of base plate: 400mm
- Weight 8kg
- Effortless mixing of large quantities
- Locking system provides multiple positions
- Sturdy wheels allow for easy positioning
- Folds for ease of storage and carrying

Item No.
MIXSTAND
FLEXTUB

**ADHESIVE MIXER PADDLE**



Mixes from bottom up

- Suitable for use with MIX850/IND & MIX1400/IND
- Available in 2 diameters 120mm & 140mm
- Length 600mm
- Designed to mix sticky and viscous materials e.g. tile adhesive, bonding mortar, jointing compound, ready mixed plaster, floor screed, fillers etc.

Item No.
MIXADH120
MIXADH140

**ADHESIVE MIXER PADDLE**



- Ideal power drill attachment for mixing small volumes of adhesive
- Unique design for effortless and thorough mixing
- Fits standard 10mm & 12mm chucks
- Blade width 65mm

Item No.
102966

**MIXER PADDLE**



- Perfect for cordless drills
- For mixing mortars, thinsets & grout
- 80mm diameter
- For use with Vitrex mixers

Item No.
MIXADH80



# Preparation





# LONG REACH SANDER

The essential tool for every plasterer & decorator, easy to use, telescopic long reach sander.



Includes 6 Abrasive discs:  
60/80/120/150/180/240 Grit



Double dust extraction outer ring



With optional interchangeable Triangular Head

- Powerful 600w motor ensures efficient power transfer to the sanding pad for smooth operation
- Variable speed ensures constant control
- 110cm short reach for use in confined areas
- Extension arm enables 165mm full working length for sanding high walls and ceilings
- Robust drive system ensures a long service life
- Double dust extraction (brush outer ring and 8-hole internal dust extraction) ensures a clean working area and prevents clogging of the abrasive surface
- 225mm diameter sanding discs
- Connect to vacuum cleaner for full dust extraction
- Folds into storage case for ease of transportation
- Interchangeable triangular head (available separately)

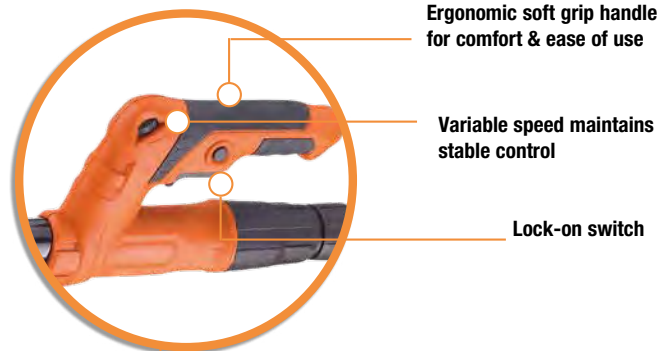

Ergonomic soft grip handle for comfort & ease of use

Variable speed maintains stable control

Lock-on switch



Foldable for easy transportation & storage

## EXTENDABLE LENGTHS



110cm



165cm

Item No.	Power Supply
LRS700	230v / 50Hz
LRS700IND	110v / 50Hz

# LONG REACH SANDER

## Triangular Head Attachement

- For use with Long Reach Sander LRS700/LRS00IND
- Quick and easy interchangeable heads

Item No.	Description
LRSDH001	Long Reach Sander Triangular Head Attachment



## REPLACEMENT DISCS

Item No.	Description
LRSDISC60	Sanding Disc 60 grit
LRSDISC80	Sanding Disc 80 grit
LRSDISC120	Sanding Disc 120 grit
LRSDISC150	Sanding Disc 150 grit
LRSDISC180	Sanding Disc 180 grit
LRSDISC240	Sanding Disc 240 grit



Item No.	Description
DHDISC60	Triangular Sanding Sheet 60 grit
DHDISC80	Triangular Sanding Sheet 80 grit
DHDISC120	Triangular Sanding Sheet 120 grit
DHDISC150	Triangular Sanding Sheet 150 grit
DHDISC180	Triangular Sanding Sheet 180 grit
DHDISC240	Triangular Sanding Sheet 240 grit

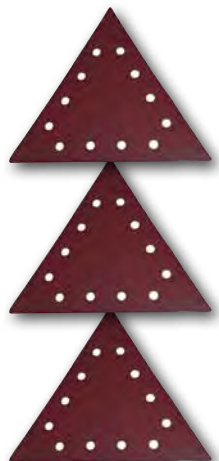

**TILE REMOVER & SCRAPER**



- Ideal for removing ceramic tile, carpet and vinyl tile
- For use in narrow and hard to reach spaces
- Includes attachment for grout removal

Item No.

TRS100



**TILE ADHESIVE & GROUT SCRAPER**



- For scraping residue off subfloors, windows and walls
- Great for wallpaper removal
- Complete with 100mm blade

Item No.

TAS100

**SPIKED AERATION ROLLER**



500  
mm

- Includes splash guard
- Ideal for subfloor preparation
- Helps remove bubbles caused by entrapped air in floor levelling compounds

Item No.

SPR500

**100MM SCRAPER BLADE**



Item No.

TRB100

- For use with TRS100 Tile Remover & Scraper
- Remove blade retaining screws, clean housing, insert new blade & replace screws

**100MM SCRAPER BLADES**



5  
pack

Item No.

TRB105

- For use with TAS100 Tile Adhesive Scraper
- Multi-blade fitment will also fit most scrapers from other manufacturers
- Remove blade retaining screws, clean housing, insert new blade & replace screws

**CHISEL SCRAPER**



- Ideal for removing tiles and residue from most surfaces
- Hammer end for quick strike use on stubborn materials
- 75mm stainless steel blade

Item No.

CHS005

**SDS SCRAPER**



- 80mm blade
- For roto-stop SDS drills, hammer action only



Item No.

SDS806



# Cutting



**TILE MARKERS (X2)**

- Suitable for marking out tiles, glass, plastic, metal and paper



Item No.
102080

**TILE SCORER**

- Tungsten Carbide tip
- Durable nylon handle with thumb recess for extra grip
- Suitable for scoring wall and floor tiles



Item No.
103175

**HEAVY DUTY TILE CUTTER**

- Tungsten Carbide wheel (ø10mm), for scoring and snapping ceramic tiles up to 10mm thick
- Heavy duty steel body, with plastic handgrips for extra comfort
- Suitable for straight and freehand cuts
- Replacement wheel kit available 101493



Item No.
101490

**JIGSAW BLADES (X2) UNIVERSAL FITTING**

- Tungsten Carbide grit edged blades
- Suitable for cutting ceramics, slate, fibreglass, plastics etc.
- Ideal for awkward shaped cuts



Item No.
102765

**TILE SCRIBE**

- Tungsten Carbide tip
- Suitable for scoring wall and floor tiles



Item No.
102075

**TILE CUTTER**

- Tungsten Carbide wheel (ø10mm), for scoring and snapping ceramic wall tiles up to 8mm thick
- Durable, glass reinforced plastic frame
- Suitable for straight and freehand cuts



Item No.
102720

**PRO SERIES HEAVY DUTY TILE CUTTER**

- Premium quality 200mm tile cutters with carbide tips
- Manufactured from drop-forged steel with a 15mm offset jaw
- The cutter operates on a simple 'score and snap' action and can be used with ceramic, marble, quarry, terracotta and slate tiles



Item No.
101500

**JIGSAW BLADES (X2) BAYONET FITTING**

- Tungsten Carbide grit edged blades
- Suitable for cutting ceramics, slate, fibreglass, plastics etc.
- Ideal for awkward shaped cuts



Item No.
102766



**VERSATILE® KNIFE**

- The perfect multipurpose knife with scoring tool for ceramic and glass tiles
- Ideal for cutting carpet and vinyl tiles
- Scoring tool stores conveniently in handle
- 3mm, 4mm & 5mm slots hold glass firmly for a clean break after scoring
- Easy blade change
- Retractable blade for added safety

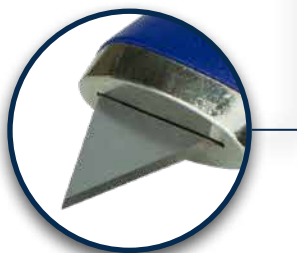

RELEASE BUTTON



MEASURING



STORAGE RELEASE



BREAK GLASS



COMFORT GRIP



SCORING TOOL



Item No.
MPK001

**CIRCLE TILE CUTTER**

- Tough, tungsten carbide cutting blade
- Safety cage
- Cuts quick, accurate circles in ceramic tiles
- Use with a variable speed drill
- Max speed 200rpm
- Variable cutting from 20-95mm



Item No.
CTC004



**TILE & GLASS DRILLS**

- Precision spear-head design prevents chipping or breaking
- High quality tile and glass drill bits, with a hardened tungsten carbide tipped point and blade for longer life

Item No.	Drill Size
102756	6mm
102757	7mm
102758	8mm
102760	10mm

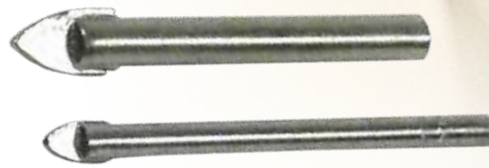

**TILE & GLASS DRILLS**

- Precision spear-head design prevents chipping or breaking
- High quality tile and glass drill bits, with a hardened tungsten carbide tipped point and blade for longer life
- 6, 8 & 10mm drill bits



Item No.	Drill Size
TGDK010	6, 8, 10mm

**MITRE SHEARS**

- Multi purpose mitre shears to easily cut tile trim, PVC piping, tackstrip and other light material
- Pre-notched guide at 45°, 60°, 75°, 90°, 105° and 120°



Item No.
102968



**DIAMOND TILE DRILL KITS**

- Diamond grit edged bit, to provide a faster, superior cut and longer lasting
- Slotted bit design for easy waste removal
- The most efficient way to cut hard and natural stone tiles
- Uses a rubber suction cup for instant positioning
- The drill has a quick-change hexagon shank to fit most power drills
- Suitable for cutting ceramic, slate, marble, porcelain, travertine, granite, quarry, terracotta and limestone tiles

Item No.	Drill Size
102791	6mm
102792	8mm
102793	10mm
102794	12mm
102795	15mm
102796	18mm
102797	22mm
102798	25mm
102799	32mm
102800	38mm



**ADVANTAGES:**

- Drills the hardest materials
- Accurate, clean cuts
- Water cooling system
- Longer life span



**UNIVERSAL HARD TILE DRILL BIT GUIDE**

- Ideal solution for drilling hard tiles
- Fully adjustable frame accommodates a wide range of bit sizes (see back of pack for details)
- 4 - 83mm
- Unique roller bearing system provides optimum stability and increased drilling accuracy
- Rubber suction cup for instant positioning
- Use in conjunction with Vitrex Hard Tile Drill Bits and Vitrex Water Cooling System



Item No.
102788

**WATER COOLING SYSTEM**

- For use with Vitrex Hard Tile Drill Bit Guides (102788 or 102789)
- Essential equipment to prevent drill bit damage through overheating
- Flexible plastic pipe for easy connection
- Simple plunger operation builds up pressure
- Trigger control with lock for continuous flow



Item No.
102790

**MINI HARD TILE DRILL BIT GUIDE**

- 4, 6, 8, 10, 12mm
- Ideal solution for drilling hard tiles
- Rubber suction cup for instant positioning
- Individual slots for the most popular fixing sizes
- Use in conjunction with Vitrex Hard Tile Drill Bits and Vitrex Water Cooling System (102790)



Item No.
102789

**6 PIECE DIAMOND TILE DRILL BIT SET**

- Carry case contains 6mm, 8mm, 10mm, 18mm, 32mm & 38mm drill bits
- Diamond grit edged bit, ideal for drilling hard tile types, including porcelain
- For use with Vitrex Drill Bit Guides and Vitrex Water Cooling System
- Slotted bit design for easy waste removal

Item No.
DDK001



**DIAMOND DRILLS & GUIDE KIT**

- Drill Guide from 4mm to 12mm
- 4, 6, 8, 10 and 12mm diamond drill bits
- Diamond grit edged drill bit, ideal for drilling hard tile types, including porcelain
- Slotted bit design for easy waste removal
- For use with Vitrex Drill Bit Guides and Vitrex Water Cooling System

Item No.	Contents
DDGKIT6	4, 6, 8, 10 and 12mm Drill Bits Drill Guide



Carry case included





**DRY CUT DIAMOND DRILLS KIT**

- Guide from 4 - 12mm
- 6, 8 & 10mm drill bits
- Diamond grit edged
- Ideal for drilling all tile types, including porcelain

Item No.	Contents
WAXDK001	6, 8 & 10mm Drill Bits & Drill Guide



**WAX DRILLS**

- Diamond grit edged drill bit suitable for use with most power drills
- Wax filled, no need for water
- Ideal for drilling in all tile types including porcelain

Item No.	Description
WAXD006	6mm Wax Drill Bit
WAXD008	8mm Wax Drill Bit
WAXD010	10mm Wax Drill Bit
WAXDKIT001	6, 8 & 10 Wax Drill & Kit



For accuracy, use with Vitrex drill guide 102788 or 102789

**WALL SYSTEM**

- Diamond grit edged bit, to provide a faster, superior cut and longer lasting
- Uses self-adhesive pads for secure positioning
- Provides the necessary lubrication to extend the life of the drill and cool the drilling surface
- Includes water delivery and collection cups for clean drilling

Item No.	Description
102770	6mm
102771	8mm



Use when installing wall fixings through tiles in kitchens and bathrooms. For a wide range of fixtures, such as shelves, towel rails & copper pipe

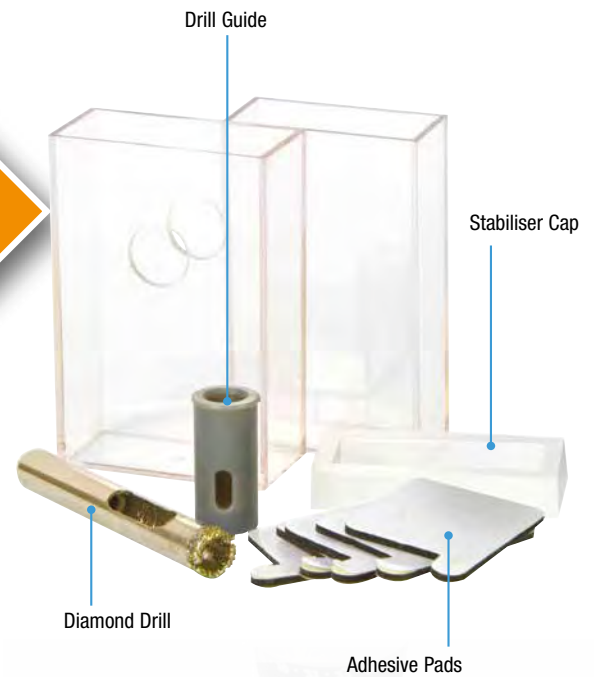

**FLOOR SYSTEM**

- Diamond grit edged bit, to provide a faster, superior cut and longer lasting
- For hole drilling in porcelain, ceramic, marble & granite
- Water cooling system keeps drill bit cool for longer life
- Secure positioning for quick and accurate drilling
- Perfect for pipe & shower head installation

Item No.
102772

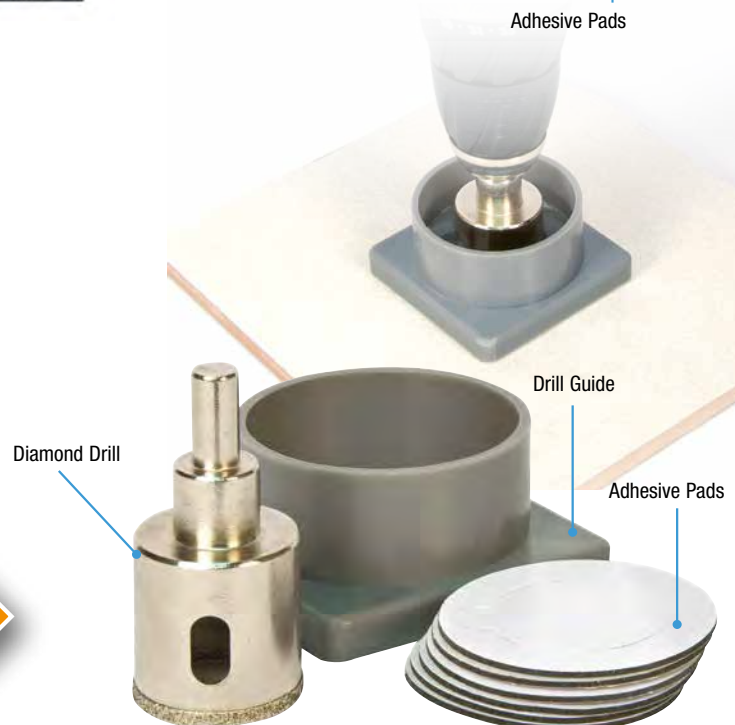



# Shaping





**PROFILE GAUGES 150-460MM**

- Quick and easy way to copy awkward shapes
- Ideal for tiling, wallpaper, laying carpet, vinyl and aligning laminate flooring
- Saves costly mistakes

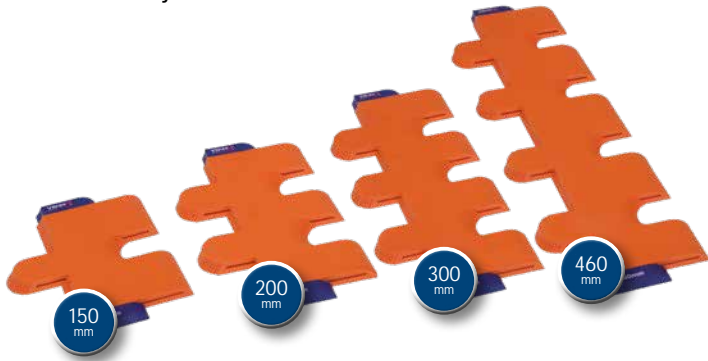

Item No.	Size
101030	150mm
101033	200mm
102461	300mm
102463	460mm

**MOSAIC & GLASS TILE FILE**

- 150mm tile file/saw
- Diamond filings for smoothing rough edges on glass & mosaic tiles
- Flat edge for smoothing straight edges
- Curved edge for smoothing contoured shapes
- Soft grip handle for secure hold and comfortable use



Item No.
MGF015

**TILE FILE (X2)**

- Tough, aluminium oxide coating
- Smooths sharp and uneven edges on cut tiles



Item No.
102116

**TILE FILE**

- 'Soft Grip' handle for extra comfort
- Tungsten Carbide grit coated file for smoothing rough edges on ceramic and marble tiles
- Flat and curved faces for straight and contoured shapes



Item No.
102120

**TILE NIPPERS**

- Tungsten Carbide tipped jaws for cutting and shaping wall tiles
- Ideal for awkward shaped cuts around pipes, switches, sills and fittings
- Soft feel handles for extra grip



Item No.

102430

**HEAVY DUTY TILE NIPPERS**

- Professional quality 200mm carbide tipped
- Rugged forged steel body, grounded & polished
- 16mm offset jaws
- Cushion grip leverage handles



Item No.

102445

**CHISEL HEAD TILE NIPPER**

**3 IN ONE**

- Multi-functional 3-in-1 tiling tool
- Nipper – durable tungsten carbide tipped jaws for cutting & shaping wall tiles
- Chisel – ideal for removing broken or damaged tiles
- Pry Bar – for lifting and re-positioning tiles
- Great for removing skirting boards



Item No.

CHN301

**MOSAIC & GLASS TILE NIPPER**

- Easily cuts glass tiles & mosaics up to 8mm thick
- Ideal for cutting awkward shapes around pipes
- Tungsten carbide cutting wheels
- Easy to use



Item No.

MGN002

**TILE SAW**

- Extra deep reinforced plastic frame for improved cutting access
- Built in “quick-release” lever for fast, easy blade replacement
- Cutting depth of 150mm i.e. to the centre of a 300mm tile



Item No.

102660

**DEEP FRAME TILE SAW**

- ‘Soft Grip’ handle for extra comfort
- Extra deep steel frame for improved cutting access
- Cutting depth of 150mm i.e. to the centre of a 300mm tile
- 150mm Tungsten Carbide blade – cuts in any direction
- Outlasts conventional hacksaw blades by up to 10 times



Item No.

102207

**TUNGSTEN CARBIDE RODSAW BLADE**

- For use with 102660 & 102207
- Tungsten Carbide blade - cuts in any direction
- Outlasts conventional hacksaw blades by up to 10 times
- Fits most standard 150mm hacksaw frames



150  
mm

Item No.

102203

**TUNGSTEN CARBIDE RODSAW BLADE**

- Tungsten Carbide blade - cuts in any direction
- Outlasts conventional hacksaw blades by up to 10 times
- Fits most standard 300mm hacksaw frames



300  
mm

Item No.

101905

# Fixing





# PRO TILING

- Rust resistant stainless steel blade
- Large, contoured handle with soft grip to ensure comfort for prolonged use
- Longer solid aluminium shank with 12 rivets
- Designed for use by the professional installer

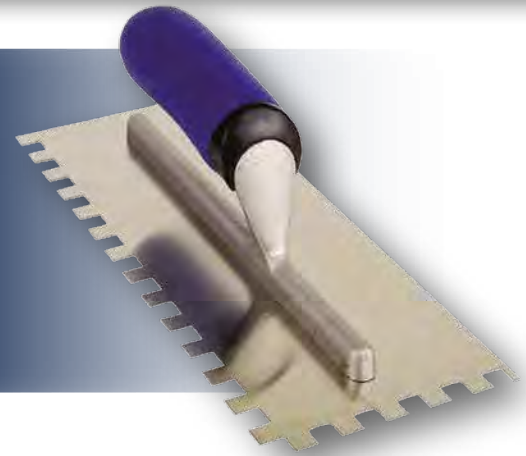

## PRO TILING ADHESIVE TROWEL 4MM SQUARE NOTCH

- Rust resistant stainless steel  
- 115 x 280mm base
- Reinforced riveted blade for longer life
- Solid aluminium shank with 'Soft Grip' handle for extra comfort

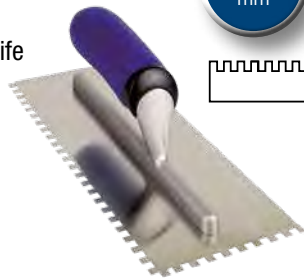

Item No.

102970

## PRO TILING ADHESIVE TROWEL 8MM SQUARE NOTCH

- Rust resistant stainless steel  
- 115 x 280mm base
- Reinforced riveted blade for longer life
- Solid aluminium shank with 'Soft Grip' handle for extra comfort



Item No.

102971

## PRO TILING ADHESIVE TROWEL 20MM ROUND NOTCH

- Rust resistant stainless steel  
- 115 x 280mm base
- Reinforced riveted blade for longer life
- Solid aluminium shank with 'Soft Grip' handle for extra comfort



Item No.

102906

## PRO TILING ADHESIVE TROWEL 6MM SQUARE NOTCH

- Rust resistant stainless steel  
- 115 x 280mm base
- Reinforced riveted blade for longer life
- Solid aluminium shank with 'Soft Grip' handle for extra comfort



Item No.

102957

## PRO TILING ADHESIVE TROWEL 10MM SQUARE NOTCH

- Rust resistant stainless steel  
- 115 x 280mm base
- Reinforced riveted blade for longer life
- Solid aluminium shank with 'Soft Grip' handle for extra comfort

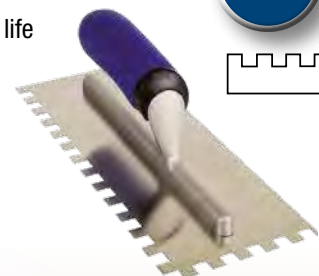

Item No.

102909



## STANDARD

- Hardened and tempered steel base, ground and polished for lasting durability
- Comfortable handle with 'Soft Grip' for prolonged use
- Long shank with 6 rivets
- Designed for use by the professional installer



### MOSAIC ADHESIVE TROWEL 4MM SQUARE NOTCH

- Hardened and tempered steel blade - 115 x 280mm base
- Large 'Soft Grip' handle for extra comfort

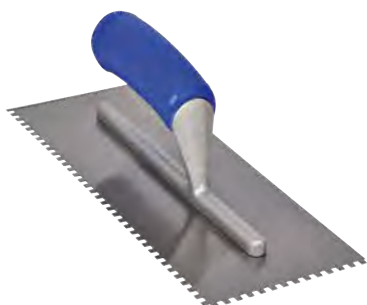
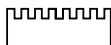

Item No.

102952

### ADHESIVE TROWEL 6MM SQUARE NOTCH

- Hardened and tempered steel blade - 115 x 280mm base
- Large 'Soft Grip' handle for extra comfort

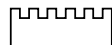

Item No.

102953

### ADHESIVE TROWEL 10MM SQUARE NOTCH

- Hardened and tempered steel blade - 115 x 280mm base
- Large 'Soft Grip' handle for extra comfort

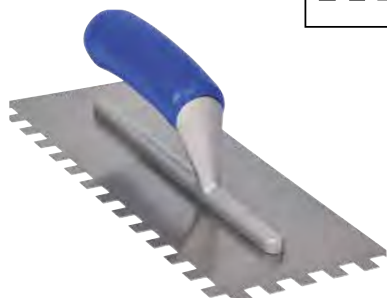

Item No.

102954

### MARGIN TROWEL FLAT NOSED

- 'Soft Grip' handle for extra comfort
- Ideal for patch jobs and for working in difficult and awkward spaces

Item No.

102908



## ECONOMY

- Hard, cold rolled steel blade for durability
- High-impact black plastic handle



### WALL ADHESIVE TROWEL 6MM SQUARE NOTCH

- Hard, cold rolled steel blade
- High impact plastic handle

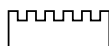

Item No.

102955

### FLOOR ADHESIVE TROWEL 20MM ROUND NOTCH

- Hard, cold rolled steel blade
- High impact plastic handle



Item No.

102956

### WALL & FLOOR ADHESIVE TROWEL 6MM SQUARE & 20MM ROUND NOTCH

- Hard, cold rolled steel blade
- High impact plastic handle



Item No.

102950

### ADHESIVE TROWEL 4MM V NOTCH & 7MM U NOTCH

- Lightweight plastic trowel
- Dual edged for use with wall and floor tile adhesives
- Comfortable ergonomic handle
- Easy to clean

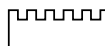

Item No.

102960

### COMBINATION WALL & FLOOR TROWEL 6MM SQUARE & 20MM ROUND NOTCH

- Lightweight, plastic trowel, with comfortable, ergonomic handle
- Dual edged for use with wall and floor tile adhesives
- Ideal for underfloor heating installations as it will not damage the wires



Item No.

102963





### COMBINATION SPREADER / FILLER

- Notched edge for fast adhesive application
- Convenient dual purpose design
- Handy 120mm filler blade



Item No.
102275

### LARGE SPREADER

- Strong flexible plastic spreader with notched edge for fast adhesive application
- Contoured handle for extra comfort



Item No.
102961

### COMBINATION SPREADER / SQUEEGEE

- Notched edge for fast adhesive application
- Convenient dual purpose design
- Squeegee edge for rapid grouting



Item No.
102277

### COMBINATION SPREADER / SQUEEGEE

- 6mm main body adhesive spreader - square notch (235mm)
- 3 x interchangeable 3mm notched spreaders for use with border/ mosaic and small tiling areas - 30mm, 40mm & 60mm
- 2 x outriggers for stability and mosaic sheet application



Item No.
BMS632

### TILE LIFT

- For easy handling of non-porous tile, marble and glass during installation
- Vacuum lifts and holds tiles up to 25 kgs (55 lbs)
- Ideal for larger format tiles



Item No.
TLT001

### NON - MARKING RUBBER Mallet

- Ideal for setting large tiles into adhesive
- Non-marking white rubber head
- Can be used in conjunction with the LASH Tile Levelling System



Item No.
101060

### COMBINATION WALL & FLOOR TROWEL/SPREADER 6MM SQUARE & 20MM ROUND NOTCH

- 2 in 1 combination trowel / spreader
- Square notches for perfect adhesive application
- Flexible easy clean rubber edge for easy grout spreading

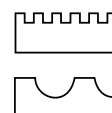

Item No.
MPSP010

### TILE INSTALLATION KIT

- Essential tools for tile adhesive and grout application

#### KIT INCLUDES

- Large Squeegee
- Tile Adhesive Spreader
- Tile Adhesive Spreader



Item No.
102964

**WALL AND FLOOR TILE SPACERS**

**The easy way to achieve a more professional tiling finish. For constant & even spacing of tiles.**

- Space wall/floor tiles evenly
- Ensures an even grout line throughout

**WALL TILE SPACERS**

Item No.	Description
102151	1.5mm (x250)
102152	1.5mm (x500)
102153	1.5mm (x1000)
102155	1.5mm (x5000)
102251	2.5mm (x250)
102252	2.5mm (x500)
102253	2.5mm (x1000)
102256	2.5mm (x3000)

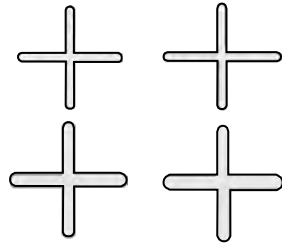

**FLOOR TILE SPACERS**

Item No.	Description
102040	4mm (x100)
102041	4mm (x250)
102042	4mm (x500)
102050	5mm (x100)
102051	5mm (x250)
102052	5mm (x500)
102056	5mm (x1500)
102070	7mm (x100)

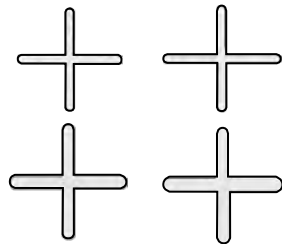

**WALL TILE SPACERS**



Item No.	Description
102000	2mm (x500)
102005	2mm (x1000)
102013	3mm (x400)
102010	4mm (x350)
102014	5mm (x250)
102015	7mm (x100)

Economy, Hollow leg Spacers



Vitrex wall and floor tile spacers are supplied in a resealable bag or tub for easy and convenient storage. Each pack features the Ready Reckoner, a quick and simple way to calculate the correct number of spacers required.

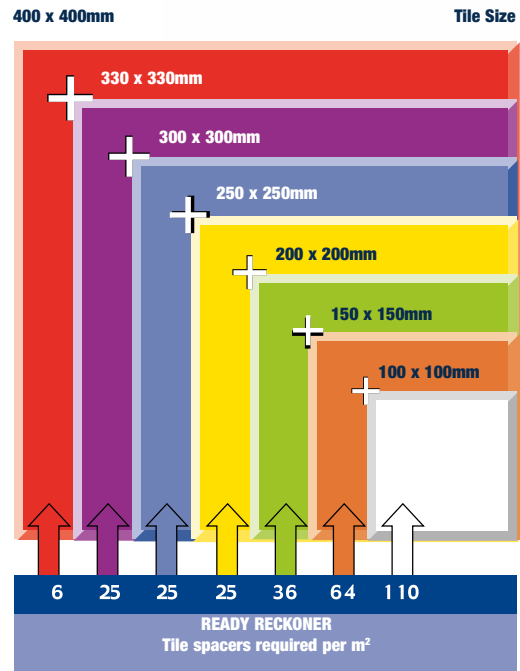

**TILE WEDGES**

- The easy way to achieve a more professional tiling finish
- Used for wall tiling when putting bottom cuts in above any uneven surface
- Micro adjust the height up to 5mm



Item No.	Description
WD250	0-5mm Tile Wedges (x250)

# PRO TILING

## LONG LEG TILE SPACERS

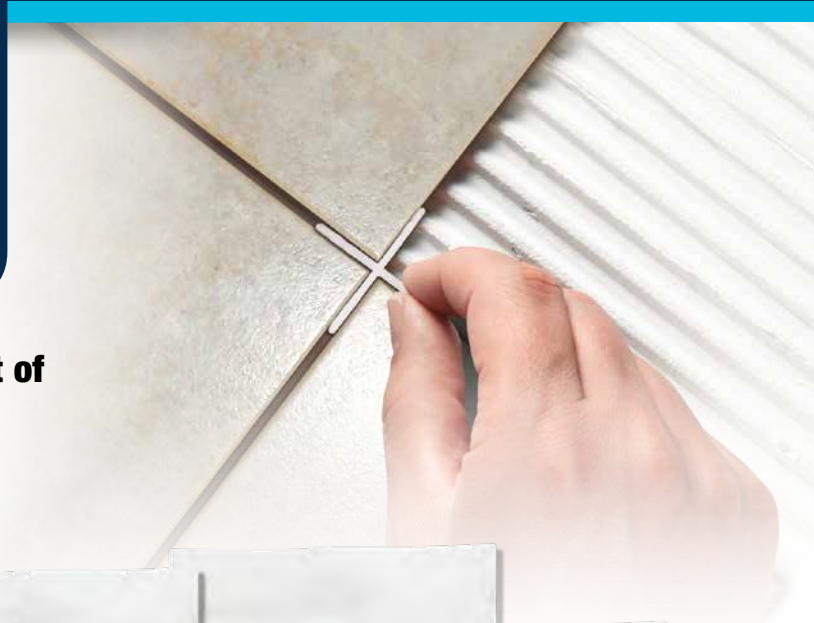

**Long leg spacers for a strong, even alignment of wall and floor tiles**

- The easy way to achieve a more professional tiling finish
- Easier to handle than standard tile spacers
- Breakable legs for T-shape spacers

Item No.	Description
LLS2250	2mm (x100)
LLS2250	2mm (x250)
LLS2500	2mm (x500)
LLS21500	2mm (x1500)
LLS22000	2mm (x2000)
LLS3250	3mm (x250)
LLS3500	3mm (x500)
LLS31500	3mm (x1500)
LLS4100	4mm (x100)
LLS4250	4mm (x250)
LLS4500	4mm (x500)
LLS41000	4mm (x1000)
LLS5100	5mm (x100)
LLS5250	5mm (x250)
LLS5500	5mm (x500)
LLS51000	5mm (x1000)

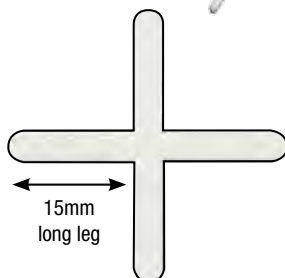

- Unlike standard tile spacers they have extra long legs (15mm) for use with larger format tiles

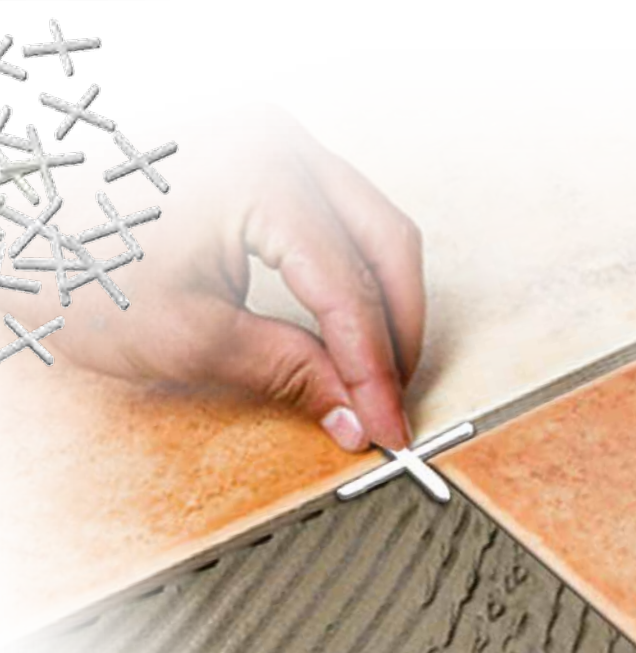





## TILE LEVELLING SPACERS

The patented LASH system is designed for quick installation and reduces costly call backs by ensuring that the finished floor surface is lippage-free. This time saving system helps adjust the height of the tiles and evenly holds their edges throughout the adhesive drying process.

**Level and Align** - The LASH clips work as a system by automatically aligning the tiles and ensuring that the surface of the tiles is level. **Space** - The clips allow the installer to space the tiles at exactly the same width throughout the installation to prevent any variation in a grout joint. **Hold** - The wedges ensure that the tiles are held at an even height until the adhesive sets.



Unique 2 piece spacer system that prevents uneven tiles



For tile thickness up to 12mm



Item No.	Description
LASH30	30 Clips & 30 Wedges
LASH150	150 Clips & 150 Wedges
LASHCL100	100 Clips
LASHWD100	100 Wedges



Scan the code to watch on **YouTube**



### STEP 1

Slide two LASH clips under the tile and into the adhesive approximately 50mm from each end of the tile. Place the second tile.



### STEP 2

Slide the reusable LASH wedges into the clips & tighten to Level, Align, Space and Hold the tiles.



### STEP 3

Once the adhesive sets, simply kick the clips, forcing them to snap off at the specially designed break-points.

# Finishing

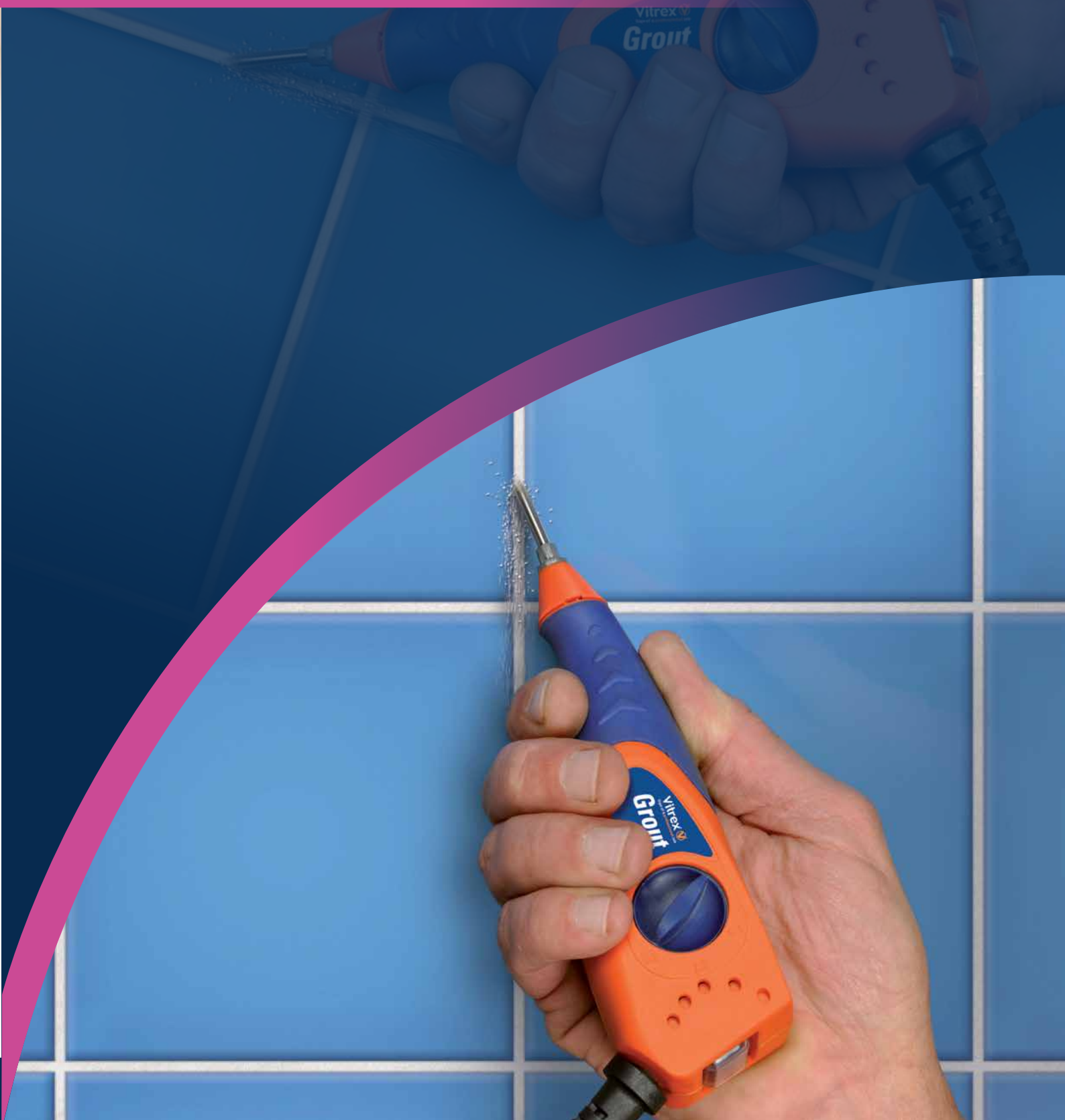

**LARGE SQUEEGEE**



- Strong flexible plastic blade with squeegee edge for rapid grouting
- Contoured handle for extra comfort

Item No.
102962

**GROUT SPREADING SQUEEGEE 225MM**

- For application of grout to walls & floors
- Soft long lasting rubber applicator



Item No.
GSS225



**GROUT FINISHER**

- Scraper end for removing excess grout
- Ball end produces a neat grout line
- Double ended tiling tool
- Easy to clean

Item No.
102280

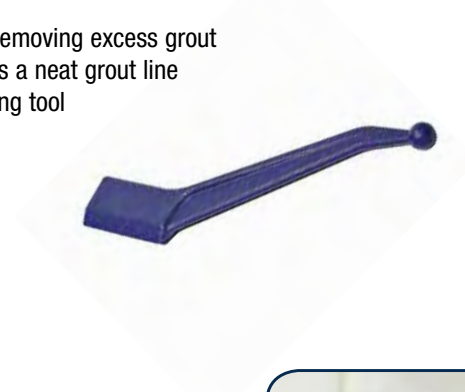

**GROUT & SILICONE REMOVER & FINISHING KIT**

- A complete kit for removing old sealant, grout & caulk
- Gives a perfect finish with newly applied materials
- 8 profiles for different finishes
- Also suitable for use with fillers

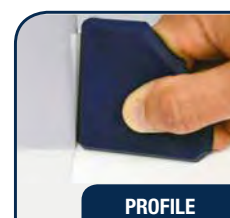
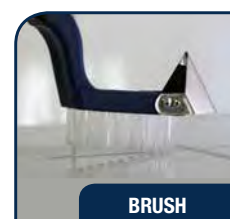
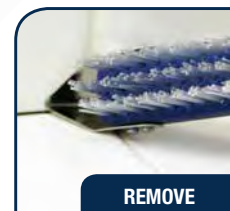

Item No.
GRS001



**FLEXI - TIP SEALANT SMOOTHER**

- Unique flexible tip for superb results on any surface
- Perfect for smoothing most household sealants, fillers, grout etc.
- Ideal for kitchens, bathrooms, showers, window frames etc.
- Simple to use and easy to clean



Item No.

102283

**SILICONE SEALANT FINISHER**

- Hand spreaders for lightweight use
- Provides a professional finish
- Ideal for baths, shower trays, worktops, sinks and interior sill
- Choice of three finishing profiles



Item No.

SIF005

**SILICONE REMOVER & FINISHER**



- Choice of 5 'easy change' finishing profiles
- All-in-one kit for a professional looking finish to silicone and grout
- Multi-functional design for a professional finish to most household sealants, silicone, fillers, grout, etc.
- Quick and simple to use

Item No.

SRF005





### ECONOMY GROUT FLOAT

- High impact handle
- Grout float with a completely moulded rubber pad to prevent absorption of grouting materials

Item No.

102911



### GUM RUBBER GROUT FLOAT

- Rubber pad mounted on a rigid polyurethane base with integral handle
- For fast, even grouting of large areas

Item No.

102901

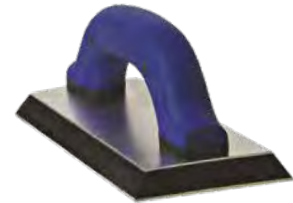

### PREMIUM GROUT FLOAT

- 'Soft Grip' handle for extra comfort
- Grout application float with high density, smooth foam
- Rubber pad for easy spreading

Item No.

102900



### SEGMENTED TILE WASH FLOAT

- Lightweight float with heavy premium quality segmented foam sponge for fast removal of grout deposits
- Ideal for washing down grouted tiles on larger projects

Item No.

102926



### TILE WASH FLOAT

- Lightweight float with heavy duty foam sponge
- Ideal for quick cleaning of large, freshly grouted areas

Item No.

102915



### MARGIN FLOAT

- 'Soft Grip' handle for extra comfort
- Latex face laminated to a lightweight foam core
- Ideal for grouting in difficult to reach and awkward spaces

Item No.

102902



## GROUT REFINISHING KIT

Complete tool kit to replace worn or discoloured grout

- Pack Contents:
- Grout spreader
  - Grout finisher
  - Grout remover

Item No.

GRK005



REMOVE

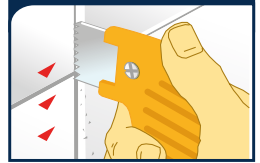

SPREAD



FINISH

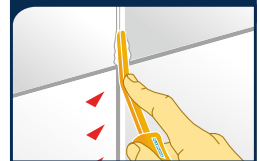

## HEAVY DUTY GROUT RAKE

- Tungsten Carbide grit edged blade for longer life
- For removing old and discoloured grout



- Replacement blades



2  
pack

Item No.

102422

102424 (Blades)

## GROUT RAKE

- Tungsten Carbide grit edged blade for longer life
- Durable nylon handle designed for extra grip
- For removing old and discoloured grout



Item No.

102420

## HEAVY DUTY GROUT RAKE

- Curved heavy duty carbide blades easily remove stubborn grout
- Use 2 blades together for wide grout joints
- Specially designed handle for comfortable firm grip



- Replacement blades



2  
pack

Item No.

HDGR100

HDGRB100 (Blades)

## GROUT RAKE WITH WHEEL

- Tungsten carbide grit edged blade for longer life
- Guide wheel helps to prevent damage to tiles



Item No.

GRA006



### PROFESSIONAL TILING SPONGE

- Heavy duty, extra large premium sponge for everything from tiling & grouting clean-up to plastering & drywall wipe down
- Unique hydrophilic design provides high liquid holding capacity
- Holds up to 4 times more liquid than standard sponges

Item No.

PTS001



### LARGE GROUTING SPONGE

- Highly absorbent premium quality grouting sponge
- Rounded edges to prevent accidental removal of fresh grout
- Rip resistant

Item No.

102904



### TILE WASH KIT

- The easy way to wash grouted tiles
- Large 11litre container with integral roller for wringing out
- Supplied with a lightweight float with heavy duty foam sponge for quick cleaning of large, freshly grouted areas

Item No.

102905



### PROFESSIONAL TILE WASH KIT

- Ideal for washing down tiles on larger projects
- Extra large 22 litre container with two integral rollers for wringing out
- Lightweight float with premium quality segmented foam sponge for fast removal of grout deposits
- Integral frame for great deposit removal

Item No.

102925



### DUAL PURPOSE GROUTING SPONGE

- Large '2 in 1' sponge ideal for cleaning and polishing tiles
- Rounded edges to prevent accidental removal of fresh grout

Item No.

102913



### GROUT CLEAN UP AND POLISHING KIT

- The easy way to clean and polish tiles
- Four interchangeable pads to suit most applications, including the removal of excess grout and grout film

Item No.

102912



# GROUT OUT

## ELECTRIC GROUT REMOVER

**THE EASIEST WAY  
TO REFRESH ANY  
TILED AREA**

- The easiest way to refresh any tiled area
- 3 speed pneumatic action powers through old and discoloured grouts
- Interchangeable grout removing tips
- 2.5m power cable allows a greater working area
- Remove old and discoloured grout

Item No.	Description
G0200VT	Grout Out
GOT002	Grout Out Replacement Tips



Scan the code  
to watch on  
**YouTube**

- Replacement tips

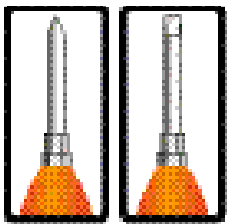

**Variable speed for  
precision grout  
removal**





# Tile Care

**Vitrex Tile Care is a range of 9 products specially formulated to Clean, Seal and Shine all the different types of tiles available and to keep them looking like new.**







## Initial Clean

Tiles require initial cleaning prior to sealing; this ensures that the tiles are in optimum condition before they are sealed.

### HEAVY DUTY TILE CLEANER

- Removes grout, limescale, adhesive residue & cement film from newly laid tiles
- Provides a deep clean prior to polishing
- Ideal for removing ingrained dirt

Item No.
THC001



Some tiles require cleaning prior to sealing to remove floor polish and protective transit coatings found on various tiles



## Everyday Clean

Maintain the natural beauty of tiles with products specifically designed for regular use.

### MARBLE & SLATE CLEANER

- Specially formulated to clean whilst providing a protective shine
- Improves the natural colour and texture of marble & slate tiles

Item No.
TSC001

1L  
Up to 40m<sup>2</sup>



### TILE CLEAN & SHINE

- Cleans & provides a protective satin shine to tiles in one application
- Enhances the texture & colour of all tiles

Item No.
TCS001

20  
washes



### MOULD REMOVER

- Removes mold and unsightly black spots
- Suitable for floor and wall tiles

500ml  
Up to 15m<sup>2</sup>

Item No.
TMR500



### GROUT CLEANER

- Easily restores grout joints to new
- Ideal for regular use

500ml  
Up to 15m<sup>2</sup>

Item No.
TGC500







## Seal

Some natural tiles are porous and need to be sealed to prevent staining. Seal prior to grouting to protect against grout stains. Seal again after installation to prevent stains from everyday spills.

### TILE SEALER

- Protects natural, unglazed tiles against stains from everyday spills such as coffee & red wine
- For use on porous tiles prior to re-waxing



Item No.
TTS001

1L  
Up to 10m<sup>2</sup>

### GROUT SEALER

- VOC compliant, solvent based formula designed for deep penetration into grout
- Protects against oil & waterbased stains whilst still allowing the surface to breathe



Item No.
TGS600

600ml  
Up to 600  
linear metres

### TILE SEAL & PROTECT

- Provides a colourless and completely natural finish on wall & floor surfaces
- Seals & impregnates mechanically polished tiles (eg: polished porcelain) and prevents any spillages seeping in to surface and causing a permanent stain



Item No.
TSS500

500ml  
Up to 25m<sup>2</sup>

## Frequently Asked Questions

### How do I know when my tiles are sealed?

All tile types differ from source to source, after applying a sealer coat leave to dry and sprinkle a little water onto the tiles if it stays in droplet form on top of the tile then the tile is sealed, if not add another coat of sealer.

### Do different tiles react in different ways to the Tile Care Products?

Yes they do, however simply by reading the instructions prior to use and testing product in a small unobtrusive area can ensure the correct results.

### How often will I need to seal my floor tiles?

For best results re-seal every 2-3 years.





## Polish

Enhance the natural beauty and durability of all tiles with polishing products which improve the brilliance of tile colour and texture and protect against everyday stains.

### FLOOR TILE POLISH

- Forms a natural satin shine protective film which prevents water, dirt & oil from penetrating into the surface, making it easier to maintain
- Enhances the natural beauty of the tiles by giving a surface sheen

Item No.

TFP001

1L

Up to 40m<sup>2</sup>



### SELECT YOUR PRODUCT...

		Polished Porcelain	Marble	Quarry	Terracotta	Slate	Porcelain	Frost Proof	Ceramic	Granite	Travertine	Limestone	Stone
Initial Clean	<b>Tile Polish &amp; Wax Remover</b>	✓		✓	✓	✓	✓	✓	✓	✓	✓	✓	✓
	<b>Heavy Duty Tile Cleaner</b>	✓		✓	✓	✓	✓	✓	✓	✓	✓		✓
Everyday Cleaning	<b>Marble &amp; Slate Cleaner</b>		✓	✓	✓	✓						✓	✓
	<b>Tile Cleaner</b>	✓	✓	✓	✓	✓	✓	✓	✓	✓	✓	✓	✓
	<b>Tile Cleaner &amp; Shine</b>	✓	✓	✓	✓	✓	✓	✓	✓			✓	✓
	<b>Grout Cleaner</b>	✓		✓	✓	✓	✓	✓	✓	✓			✓
	<b>Mould Remover</b>	✓		✓	✓	✓	✓	✓	✓	✓			✓
Seal	<b>Tile Seal &amp; Protect</b>	✓	✓	✓	✓	✓	✓	✓	✓	✓	✓	✓	✓
	<b>Tile Sealer</b>		✓	✓	✓	✓				✓	✓	✓	✓
	<b>Grout Sealer</b>	✓	✓	✓	✓	✓	✓	✓	✓	✓	✓	✓	✓
Shine	<b>Floor Tile Polish</b>	✓		✓	✓	✓	✓	✓	✓				✓
	<b>Tile Colour Enhancer</b>	✓	✓	✓	✓	✓	✓	✓	✓	✓	✓	✓	✓

### TILE TYPES

Polished Porcelain

Marble

Quarry

Terracotta

Slate

Porcelain

Frost Proof

Ceramic

Granite

Travertine

Limestone

Stone

# Ancillaries/Kits



**TILING STARTER KIT**

- All the basic tools required to cut, fix and grout tiles



**KIT INCLUDES**

- Tile Marker
- Tile Scorer
- Tile File
- 1.5mm Tile Spacers (x100)
- Combination Spreader / Squeegee
- Grout Finisher

Item No.

102810

**TILE RE-GROUTING KIT**

- All the basic tools required to re-grout your tiles



**KIT INCLUDES**

- Grout Rake
- Combination Spreader / Squeegee
- Grout Finisher
- Clean up Sponge

Item No.

102285

**TILE INSTALLATION KIT**

- Essential tools for tile adhesive and grout application



**KIT INCLUDES**

- Large Squeegee - Strong flexible plastic blade with squeegee edge for rapid grouting, contoured handle for extra comfort
- Tile Adhesive Spreader - 4mm V notch, strong flexible plastic spreader for fast adhesive application
- Tile Adhesive Spreader - 6mm square notch, strong flexible plastic spreader for fast adhesive application

Item No.

102964

**TILING KIT**

- All the basic tools required for installation and finishing
- Supplied in convenient storage bag



**KIT INCLUDES**

- Combination Wall & Floor Trowel - 6mm Square & 20mm Round
- Dual Purpose Grouting Sponge
- Grout & Sealant Smoother
- Grout Float

Item No.

TILEKIT01



**SINGLE WHEEL GLASS CUTTER**

- Die cast metal body
- Tungsten steel wheel, ø 7mm
- Integral notches for 'breaking out'
- Ball end for tapping glass



Item No.
700335

**SIX WHEEL GLASS CUTTER**

- Durable nylon body
- Six tungsten steel wheels, ø 4mm
- Integral notches for 'breaking out'
- Ball end for tapping glass



Item No.
701380

**LAMINATE CUTTER**

- Simple cutting process helps to speed up the installation
- Easy to use, the blade speeds accurately through cuts
- The 'V' support ensures the laminate panels are held level and secure during the cut
- The long life blade requires no maintenance

- Cuts laminate up to 200mm (8")
- Cuts at 90°
- Produces a clean and professional finish
- Unique blade engineered for safe cutting
- Includes positional block to support plank whilst cutting



**Guaranteed to provide quick and easy cuts for all laminate wood.**

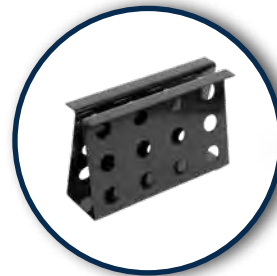

**Included 'V' Support**  
Positionable support keeps planks level whilst cutting

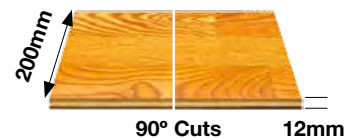

Item No.
800100

# Vitrex®

Sign of a **professional** job

THE WORLD'S LEADING SUPPLIER OF TILING & FLOORING INSTALLATION EQUIPMENT

-  **The Maltsters, Wetmore Road, Burton Upon Trent DE14 1LS UK**
-  **T: +44 (0) 1283 245 430 F: +44 (0) 1283 245 431**
-  **sales@qep.com**
-  **www.vitrex.co.uk**



A division of  
**QEP**

**HOMELUX**

**PLASPLUGS®**

**XPS foam™**  
ADVANCED UNDERLAY SYSTEMS

**Vitrex®** 

**PORTA-NAILS™**

**ROBERTS**

**PRCI**  
L'outil de points

**IONECANC**  
benetton

**QEP**

**Vitrex<sup>®</sup>**   
Sign of a **professional** job

# FLOORING TOOLS & ACCESSORIES

INSTALLATION TOOLS

FINISHING

ADHESIVES

MAINTENANCE

SCOTIAS

THRESHOLDS

CARPET TILES

MERCHANDISING

**NEW**  
PRODUCTS  
INSIDE

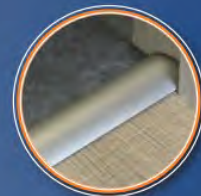



# CONTENTS



**INSTALLATION TOOLS** 3



**FINISHING** 8



**ADHESIVES** 10



**MAINTENANCE** 12



**SCOTIAS** 14



**THRESHOLDS** 16



**CARPET TILES** 19



**MERCHANDISING** 23

## INSTALLATION TOOLS

Introducing a comprehensive range of Vitrex branded flooring tools and accessories to suit both trade and DIYer needs.

Includes Kits with all the essential tools needed for easy DIY installation.

### 800100 | Laminate Cutter

- Simple cutting process helps to speed up the installation
- Easy to use, the blade speeds accurately through cuts
- The 'V' support ensures the laminate panels are held level and secure during the cut
- The long life blade requires no maintenance
  - Produces a clean and professional finish
  - Includes positional block to support plank whilst cutting
  - Cuts laminate up to 200mm (8")
  - Unique blade engineered for safe cutting
  - Cuts at 90°



NEW

Item No.	Description	Qty
800100	Laminate Cutter	4



[sales@qep.com](mailto:sales@qep.com) | 01283 245430

Vitrex  | 3



# INSTALLATION TOOLS

## HFIK006 Pro Flooring Installation Kit

- This kit has all the tools you need to help you install laminate, wood and LVT flooring
- Includes:



### Multi Purpose Expansion Spacers x30

- 30 multi-use spacers with multi-sided design for maintaining expansion joint spacing of 6mm (1/4") for vinyl, 12.5mm (1/2") for laminate/hardwood and 25mm (1") for thresholds
- Patent pending 3 sided design
- Ensures accuracy in expansion joint spacing

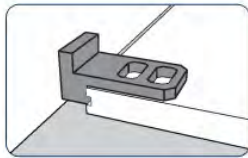

### Two Headed Mallet

- A double faced 340 gram (16oz) non marking mallet used with the tapping block or pull bar to move flooring into place
- Durable polyfibre handle
- Used to secure glued/click-lock vinyl (red end), or laminate/hardwood floor (yellow end)



### Dual Sided Tapping Block

- Two sided universal tapping block, engineered to push edges of vinyl tile, laminate or hardwood flooring planks together without damaging the tongue and groove / locking system. One side for vinyl and the other for wood
- Uniquely designed to be used with the Vitrex Mallet
- Closes gaps between planks without damaging the tongue and groove or locking system

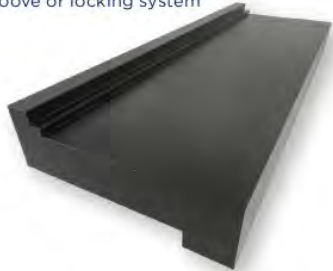

Vinyl

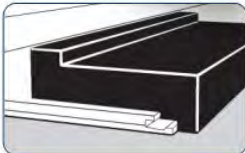

Wood



### Extreme Angle Pull Bar

- Wide angle metal pull bar used to pull planks together when against the wall
- Ideal for moving planks together
- Perfect for where space is limited or against a wall



Item No.	Description	Qty
HFIK006	Pro Flooring Installation Kit	6



# INSTALLATION TOOLS

## ITLAMSPA | Laminate & Wood Flooring Spacers

- Designed to give a consistent gap around skirting boards when installing laminate, wood and LVT flooring
- Maintains an even expansion gap when installing flooring



Item No.	Description	Qty
ITLAMSPA	Laminate & Wood Flooring Spacers	6

## WLFITKIT | Wood & Laminate Fitting Kit

- This kit has all the tools you need to help you install laminate and wood flooring. Includes:
- 30 standard flooring spacers for an even expansion gap
- Tapping block to help achieve tight joints
- Wide angle metal pull bar used to pull planks together when against the wall



Item No.	Description	Qty
WLFITKIT	Wood & Laminate Fitting Kit	10

## HBDPULLBAR | Heavy Duty Pull Bar

- Wide angled metal bar used to pull planks together when against the wall
- Steel construction
- Soft felt pad protects floors from scratching during installation



Item No.	Description	Qty
HBDPULLBAR	Heavy Duty Pull Bar	8

## ITBTENSTRP | Tension Strap

- Ideal installation aid for laying tongue and groove or glued flooring
- Ratchet system allows easy tightening
- Metal plates with curved edges to give a good fit on flooring



Item No.	Description	Qty
ITBTENSTRP	Tension Strap	6

# INSTALLATION TOOLS

## FWS010 | Floor & Wall Scraper

- Handy, portable heavy duty scraper which is used to easily remove wall and floor coverings such as adhesive
- Quick blade change, with screwdriver tool in the handle
- 100mm blade with an extra 5 blades included
- Handy blade storage in the handle



Item No.	Description	Qty
FWS010	Floor & Wall Scraper	10
FWS010RB	Scraper Blades x10	6

## PB006 | Pro Mini Pry Bar

- Enables easier removable of moulding, gripper and nails
- Designed to provide maximum leverage in tight spots
- 32° angle for quick gripper removal
- Features a deep bevel nail slot



Item No.	Description	Qty
PB006	Pro Mini Pry Bar	3

## VITCARPKN | Carpet Knife

- Designed with an offset head allowing more room for your knuckle, achieving a precise cutting angle
- Large contoured handle
- Unscrew end cap and swing open for easy blade change
- Handle stores additional blades



Item No.	Description	Qty
VITCARPKN	Carpet Knife	12

## GSC001 | Gripper & Scotia Cutter

- The perfect way to cut scotias and gripper at angles between 45° - 135°, producing cuts to give a clean joint finish
- Clear angle markings to cut at required angles
- Comfort grip for prolonged use



Item No.	Description	Qty
GSC001	Gripper & Scotia Cutter	6



## INSTALLATION TOOLS

### ITEXPSTRIP | Expansion Strips

- Used to provide an even space around the outside of your room when installing wood and laminate flooring, which requires spacing for expansion
- Contains 18 pieces giving a coverage of 36ft
- Made from cork, making it easy to cut to the required length



Item No.	Description	Qty
ITEXPSTRIP	Expansion Strips	12

### VITCARPTUC | Carpet Tucker

- Lightweight nylon carpet tucking tool
- Non marking, double edged - square and curved
- Square edge is for tucking carpet into corners
- Curved edge is for tucking carpet into stairs



Item No.	Description	Qty
VITCARPTUC	Carpet Tucker	4

### SPR500 | Spiked Roller 500mm

- Includes splash guard
- Ideal for subfloor preparation
- Helps remove bubbles caused by entrapped air in floor levelling compounds



Item No.	Description	Qty
SPR500	Spiked Roller 500mm	1

### 338160 | Flooring Knee Pads

- Ideal to use when installing tiles, wood, vinyl and other hard floors
- Slip resistant pads for added safety
- Comfort form fitting foam padding
- Easy on and off adjustable, no hassle plastic buckle



Item No.	Description	Qty
338160	Flooring Knee Pads	6



## FINISHING

### Colour Sealant 310ml

- Perfect for applying a finishing touch or filling smaller gaps on flooring installations
- Permanently flexible sealant and gap filler
- For sealing around wood, laminate and LVT flooring
- Adheres to all surfaces



Item No.	Description	Qty
ADS150L	Colour Sealant 310ml - Light	6
ADS150M	Colour Sealant 310ml - Medium Wood	6
ADS150D	Colour Sealant 310ml - Dark Wood	6
ADS150G <small>NEW</small>	Colour Sealant 310ml - Grey	6

### CGS310 | Cartridge Gun

- An essential tool to use with silicone or adhesive cartridges
- Lightweight and robust skeleton gun



Item No.	Description	Qty
CGS310	Cartridge Gun	12

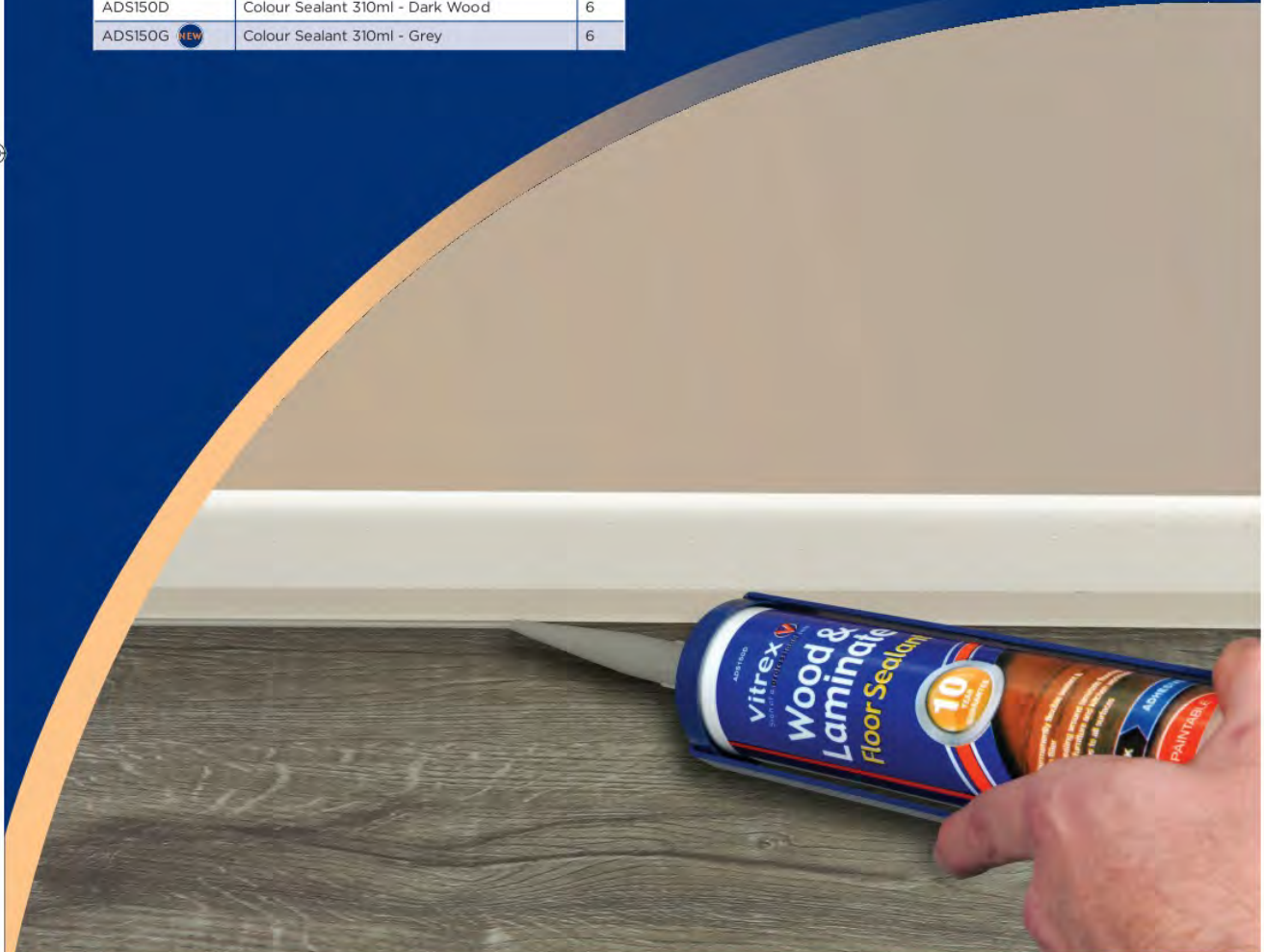

## FINISHING

### Plastic Pipe Surrounds

- The finishing touch for your radiator pipes
- For covering exposed pipes up to 15mm



Item No.	Description	Qty
PRHBSILV	Silver Plastic Pipe Surrounds	100
PRHBROSWH	White Plastic Pipe Surrounds	100

### Plastic Pipe Covers

- The finishing touch to your radiator pipes
- For covering exposed pipes up to 15mm



Item No.	Description	Qty
PRHBSWHITE	White Plastic Pipe Covers	12
PRHBSSILV	Silver Plastic Pipe Covers	12

### PSURGREY Self Adhesive Pipe Surrounds Light Grey

- The finishing touch to your radiator pipes to match your floor
- For covering expansion gaps around 15mm diameter pipes
- Easy to install, remove backing and stick in required position

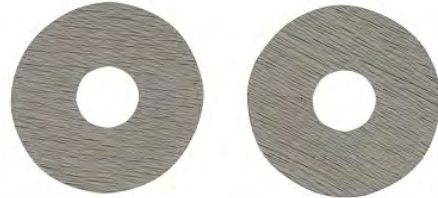

Item No.	Description	Qty
PSURGREY <small>NEW</small>	Self Adhesive Pipe Surrounds Light Grey	100

### Real Wood Pipe Surrounds Light

- The finishing touch to your radiator pipes to match your floor
- For covering expansion gaps around 15mm diameter pipes



Item No.	Description	Qty
PRRWLIGHT	Real Wood Pipe Surrounds Light	12
RWPRMED	Real Wood Pipe Surrounds Medium	12
RWPRDARK	Real Wood Pipe Surrounds Dark Oak	12
RWPRGREY <small>NEW</small>	Real Wood Pipe Surrounds Light Grey	12



## ADHESIVES

Our range of multi-purpose tapes are ideal for single and double stick installations for carpets, carpet tiles, underlay and flooring.

We also provide spray and cartridge adhesives for fixing trim, skirting, wood and laminate.

### SSULTAPE | Underlay Joint Tape

- Single sided adhesive tape for wood, laminate and carpet underlays
- 50mm width x 10m length



Item No.	Description	Qty
SSULTAPE	Underlay Joint Tape	10





## ADHESIVES

### HBVT48M | Vinyl Floor Joint Tape

- Double sided adhesive tape for use on vinyl flooring
- 50mm width x 15m length



Item No.	Description	Qty
HBVT48M	Vinyl Floor Joint Tape	10

### LAMULTAPE | Foil Joint Tape for Laminate Underlay

- Single sided adhesive tape for laminate underlay
- 50mm width x 10m length
- Provides a vapour barrier and strengthens underlay joints



Item No.	Description	Qty
LAMULTAPE	Foil Joint Tape for Laminate Underlay	10

### ADCARTAP | Carpet Tape

- Double sided adhesive tape for joining carpets
- 50mm width x 10m length



Item No.	Description	Qty
ADCARTAP	Carpet Tape	10

### HADMULFIX250 | Skirting & Trim Adhesive

- High strength, multi use adhesive used for gluing flooring trims to skirting boards or walls
- Use to fix skirting boards, dado rails, door surrounds & wall panels Ideal for gap filling
- Over paintable
- Solvent free



Item No.	Description	Qty
HADMULFIX250	Skirting & Trim Adhesive	6

### ADSPRAY | Heavy Duty Spray Adhesive 500ml

- High tack adhesive which adheres to most common substrates
- Use for laying PU & foam backed carpets, carpet tiles and cork
- Easier to apply than adhesive applied with a trowel
- Repositionable with a fast rate of tack
- CFC free, foaming formula gives low soak into substrates



Item No.	Description	Qty
ADSPRAY	Heavy Duty Spray Adhesive 500ml	12

### ADLAM500 | Wood & Laminate Adhesive 500ml

- High strength, interior and exterior use white adhesive
- Easy to clean up and dries clear in just ten minutes
- Provides a high strength, impact-resistant bond that is usually stronger than the wood itself
- Conforms to the international standard EN 204 (D3) and BS 14256 for creep resistance
- Environmentally-friendly



Item No.	Description	Qty
ADLAM500	Wood & Laminate Adhesive 500ml	20



# MAINTENANCE

## VMKBOX | LVT 3 Step Maintenance Kit

- A 3 step kit specially designed for LVT flooring to clean, protect and maintain your floors appearance
- Step 1 - pH neutral daily cleaner to keep your floor clean with no streaks and shiny build up  
Step 2 - Intensive cleaner to use monthly or when required for deep cleaning  
Step 3 - Revitalise your floor and apply after the Intensive Cleaner to achieve the "original" look of your flooring and leave a protective coating
- Includes 27 self adhesive pads in assorted sizes



**NEW**

Item No.	Description	Qty
VMKBOX	LVT 3 Step Maintenance Kit	4

## REPAIRKIT | Universal Repair Kit All In One

- Suitable for wood floors & furniture, laminate floors and counters, cabinets and moldings & vinyl floors
- Containing 6 colours and a formula chart, to mix and create unlimited shades
- Quickly repair scratches, cracks and other damage



Item No.	Description	Qty
REPAIRKIT	Universal Repair Kit All In One	3



**Formula Chart**

No mixing required for colours A-F.  
Mix the basic colours A-F to create other colours below.  
Modify the mixture in order to adjust the colour to match as required.

	B Brown	C Burgundy	D Tan	E Black	F Grey
1	2	3	4	5	6
7 parts A 1 part C	5 parts A 5 parts B 1 part C	3 parts C 1 part D	1 part B 10 parts D	4 parts B 1 part C 2 parts E	8 parts A 1 part B 5 parts D
8	9	10	11	12	13
1 part A 1 part C 1 part D	5 parts B 10 parts D 1 part E	12 parts A 8 parts D 1 part E	6 parts F 1 part D	8 parts F 8 parts D 1 part E	3 parts A 2 parts F 1 part E



# MAINTENANCE

## SPT1024 Stay n Place Adhesive Tabs x4

- Used for rugs and mats to prevent bunching and shifting
- Ideal for any hard floor surface (indoor use only)
- 4 adhesive tabs which are 10x10cm
- Easy to cut



Item No.	Description	Qty
SPT1024	Stay n Place Adhesive Tabs x4	48

## FPFELT Self-Adhesive Felt Pads

- Placed under furniture help protect your wood, laminate & LVT flooring
- Help to protect your furniture and floor by avoiding unnecessary scratches & dents
- Adheres to most smooth, clean, dry surfaces
- 27 self adhesive pads in assorted sizes



Item No.	Description	Qty
FPFELT	Self-Adhesive Felt Pads	10

## RMCARP Rug-Mate non-slip pad for Carpets

- Non-slip pad which helps keep your rug in place on carpets
- Prevents rugs from wrinkling and slipping
- Protects and preserves carpet below
- Rug is easier to vacuum with pad
- Fits rug sizes up to 60cm x 120cm  
Pad size is 53.3cm x 106.6cm



Item No.	Description	Qty
RMCARP	Rug-Mate non-slip pad for Carpets	32

## RMLRG25 Rug-Mate non-slip pad for Carpets

- Non-slip pad which helps keep your rug in place on wooden or laminate floors
- Non-slip gripping power
- Protects wood and laminate floors from staining
- Fits rug sizes up to 1.2m x 1.8m



Item No.	Description	Qty
RMLRG25	Rug-Mate non-slip pad for Wood & Laminate Floors	25

## RMECON Rug-Mate non-slip pad for Wood & Laminate Floors

- Non-slip pad which helps keep your rug in place on wood, laminate and LVT floors
- Prevents rugs from wrinkling and slipping
- Protects wood and laminate floors from staining
- Rug is easier to vacuum with pad
- Fits rug sizes up to 60cm x 120cm  
Pad size is 53.3cm x 106.6cm



Item No.	Description	Qty
RMECON	Rug-Mate non-slip pad for Wood & Laminate Floors	32

## GRIPMATE Grip Mate Non-Slip Pad

- Non-slip, non adhesive pad which helps stop movement
- Easy to cut, fit & clean
- Large size 50cm x 1.5m
- Easily cut to size



Item No.	Description	Qty
GRIPMATE	Grip Mate Non-Slip Pad	8

## SCOTIAS

Scotias cover the gap between the floor and wall or existing skirting boards to create a neat and professional finish around wood, laminate and LVT flooring.

Vitrex Scotias are manufactured in MDF and Solid Oak.

Our comprehensive range can be matched with most floor colours.

All Scotias are 2m in length.

### Material Types



MDF



Solid Oak

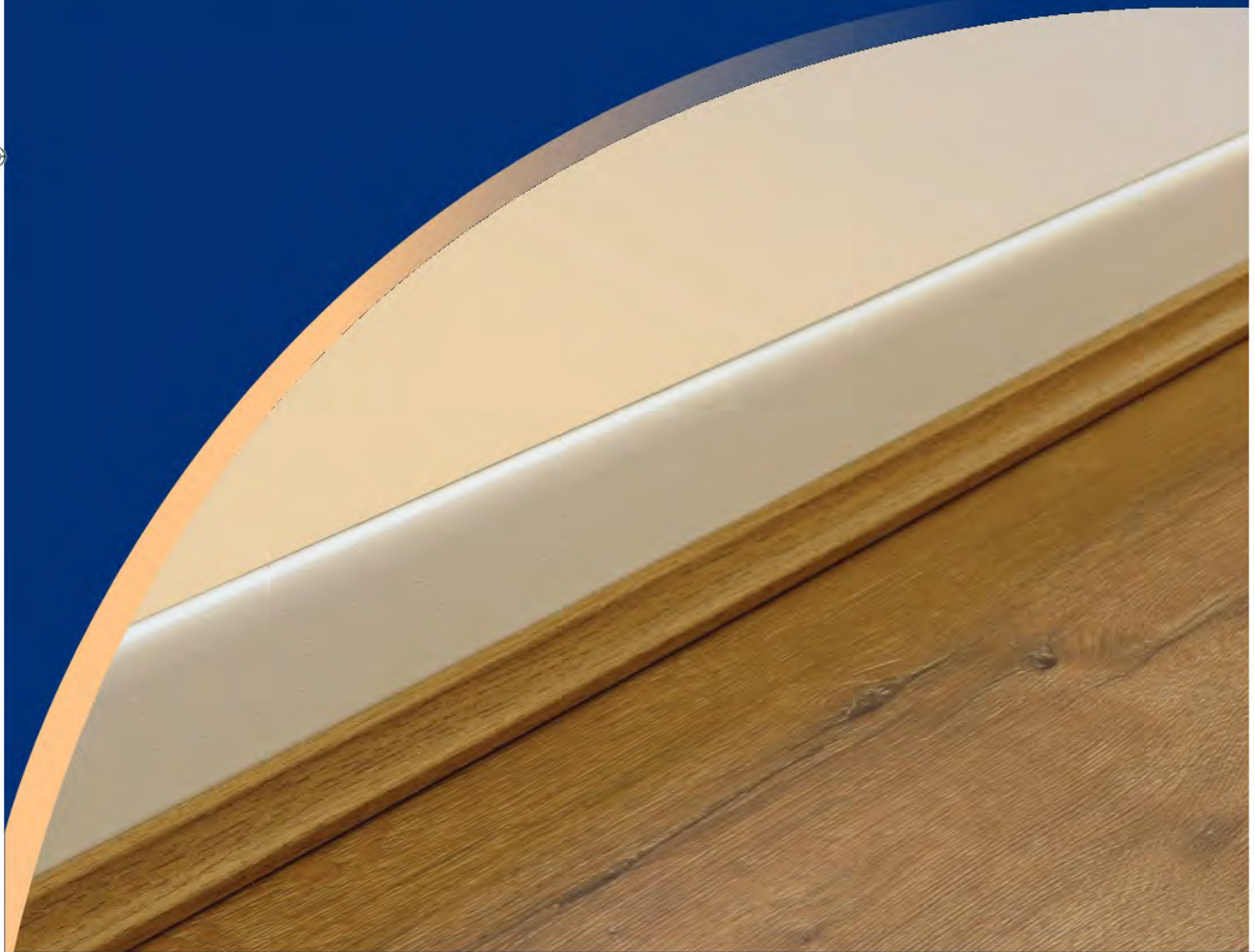



# SCOTIAS

## MDF Scotias : 2m



Item No.	Description	Matching Threshold	Qty
SC612	White	-	10
SC6125PCK	5 Pack White	-	5
SE001	Epp White	-	10
SC607	Shimla/Albero/Salarno Oak	Yes	10
SC619	Aspen Oak	Yes	10
SE012	Stowe Oak	Yes	10
SC602	Arreton Light Grey	Yes	10
SC626	Chenai Grey Gloss	Yes	10
SE010	Grey Oak	Yes	10
SC631	Elderwood	Yes	10
SC633	Pale Oak	Yes	10
SC629	Abbotsbury/Clovelly	Yes	10
SC601	Venezia/Sevilla Oak	Yes	10
SC625	Oak	Yes	10
SE007	Richmond Oak	-	10
SE011	Conniston Hickory	Yes	10
SC603	Navelli Oak	Yes	10
SC632	High Gloss	Yes	10
SC605	Madeira Light Hickory	Yes	10
SC628	Windsor	Yes	10
SC608	Bergen Oak	Yes	10
SC630	Galloway	Yes	10
SE003	Dark Oak	Yes	10
SC617	African Walnut	Yes	10

## Solid Oak Scotias : 2m



Item No.	Description	Matching Threshold	Qty
SC622	Solid Oak	-	10

## THRESHOLDS

Thresholds are designed to cover the join or gap between two floor coverings.

We have a wide variety of profiles to cater for all combinations of floor coverings as well as Variable Height Thresholds, which are available in matching colours to our Scotia range.

### Profiles



Variable Height



Vinyl Edge



Smooth Cover



Carpet to Laminate



Carpet to Carpet



Carpet Cover Strip



Extra Wide Cover Strip



Carpet Edging



Step Edge

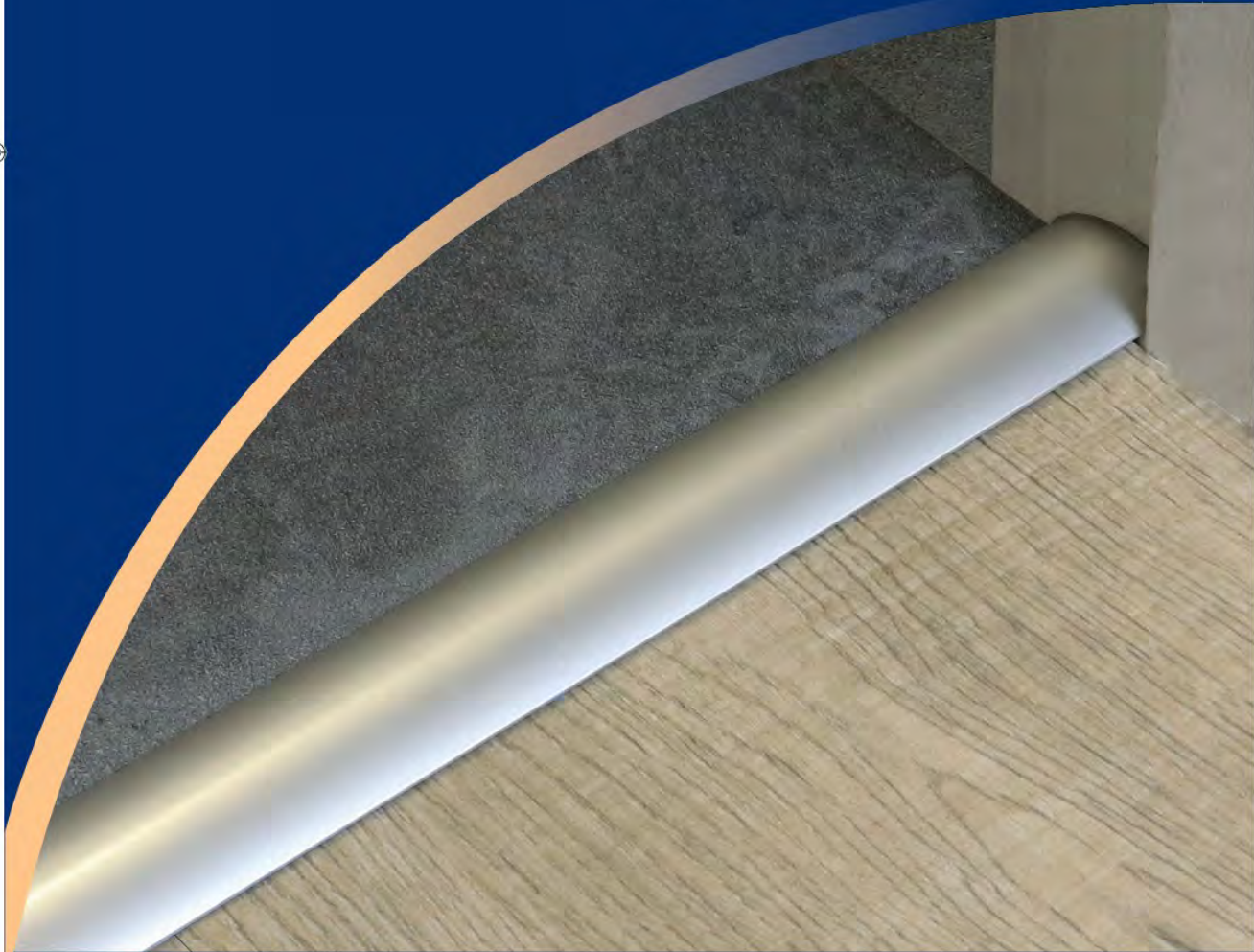



# THRESHOLDS

## Variable Height Thresholds

- Variable Heights join floor coverings of similar or differing heights from 7 to 21mm
- Self Adhesive

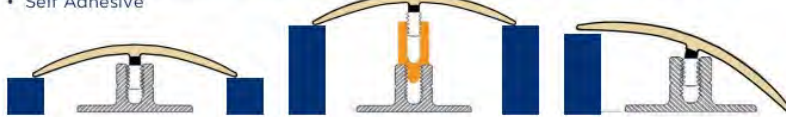

Item No.	Description	Matching Scotias	Size	Qty
VH008	Silver	-	38mm - 0.9m	10
VH0088	Silver	-	38mm - 1.8m	5
VH009	Gold	-	38mm - 0.9m	10
VH0099	Gold	-	38mm - 1.8m	5
VH709	Shimla/Albero/Salerno Oak	Yes	38mm - 0.9m	10
VH722	Aspen Oak	Yes	38mm - 0.9m	10
VH004	Stowe Oak	Yes	38mm - 0.9m	10
VH0048	Stowe Oak	Yes	38mm - 1.8m	5
VH9003	Stowe Oak	Yes	50mm - 0.9m	10
VH1803	Stowe Oak	Yes	50mm - 1.8m	5
VH725	Arreton Light Grey	Yes	38mm - 0.9m	10
VH729	Chenai Grey Gloss	Yes	38mm - 0.9m	10
VH005	Grey Oak	Yes	38mm - 0.9m	10
VH0058	Grey Oak	Yes	38mm - 1.8m	5
VH9004	Grey Oak	Yes	50mm - 0.9m	10
VH1805	Grey Oak	Yes	50mm - 1.8m	5
VH734	Elderwood	Yes	38mm - 0.9m	10
VH0038	Light Oak	Yes	38mm - 1.8m	5
MH9004	Light Oak	Yes	50mm - 0.9m	10
MH800LO	Light Oak	Yes	50mm - 1.8m	5
VH736	Pale Oak	Yes	38mm - 0.9m	10
VH737	Pale Oak	Yes	38mm - 1.8m	5

Item No.	Description	Matching Scotias	Size	Qty
VH732	Abbotsbury/Clovelly	Yes	38mm - 0.9m	10
VH703	Venezia/Sevilla Oak	Yes	38mm - 0.9m	10
VH714	Oak	Yes	38mm - 0.9m	10
VH738	Oak	Yes	38mm - 1.8m	5
VH728	Oak	Yes	50mm - 0.9m	10
MH9008	Medium Oak	Yes	50mm - 0.9m	10
VH001	Conniston Hickory	Yes	38mm - 0.9m	10
VH0018	Conniston Hickory	Yes	38mm - 1.8m	5
VH9001	Conniston Hickory	Yes	50mm - 0.9m	10
VH1801	Conniston Hickory	Yes	50mm - 1.8m	5
VH705	Navelli Oak	Yes	38mm - 0.9m	10
VH735	High Gloss	Yes	38mm - 0.9m	10
VH707	Madeira Light Hickory	Yes	38mm - 0.9m	10
VH731	Windsor/Keswick	Yes	38mm - 0.9m	10
VH710	Bergen Oak	Yes	38mm - 0.9m	10
VH733	Galloway	Yes	38mm - 0.9m	10
MH9032	Dark Hickory	Yes	50mm - 0.9m	10
VH002	Holloway Chestnut (Dark Oak)	Yes	38mm - 0.9m	10
VH0028	Holloway Chestnut (Dark Oak)	Yes	38mm - 1.8m	5
VH9002	Holloway Chestnut (Dark Oak)	Yes	50mm - 0.9m	10
VH1802	Holloway Chestnut (Dark Oak)	Yes	50mm - 1.8m	5
VH718	African Walnut	Yes	38mm - 0.9m	10



## Vinyl Edge Thresholds

- Designed for use with vinyl floor coverings up to 4.5mm in thickness



Item No.	Description	Width	Size	Qty
FEVE900G	Vinyl Edge Gold	32mm	0.9m	10
FEVE900S	Vinyl Edging Silver	32mm	0.9m	10

## Smooth Cover Thresholds

- Conceals and protects the joints between all grades and thickness of wood, laminate and LVT floor coverings



Item No.	Description	Width	Size	Qty
FESF900G	Smooth Floor Cover Strip Gold	38mm	0.9m	10
FESF900S	Smooth Floor Cover Strip Silver	38mm	0.9m	10

# THRESHOLDS

## Carpet to Laminate/Ceramic Thresholds

- For connecting carpet to laminate or ceramic flooring

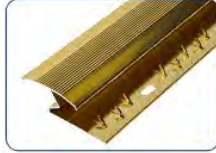

Item No.	Description	Width	Size	Qty
FECL900G	Carpet To Ceramic Gold	27mm	0.9m	10
FECL900S	Carpet To Ceramic Silver	27mm	0.9m	10
FEC1800G	Carpet To Laminate Gold	27mm	1.8m	5
FEC1800S	Carpet To Laminate Silver	27mm	1.8m	5

## Carpet to Carpet Thresholds

- Designed to achieve a neat and well secured join between two carpets



Item No.	Description	Width	Size	Qty
FECC900G	Carpet To Carpet Gold	20mm	0.9m	10
FECC900S	Carpet To Carpet Silver	20mm	0.9m	10

## Carpet Cover Strip Thresholds

- This profile has two ridges on the sections base which enables it to bite into the nap of the carpet and hold it firmly in place



Item No.	Description	Width	Size	Qty
FECS900G	Carpet Cover Strip Gold	39mm	0.9m	10
FECS900S	Carpet Cover Strip Silver	39mm	0.9m	10
FEC1800G	Carpet Cover Strip Gold	39mm	1.8m	5
FEC1800S	Carpet Cover Strip Silver	39mm	1.8m	5

## Extra Wide Cover Strip Thresholds

- Extra wide cover strip to cover the space between two hard floors

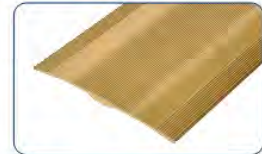

Item No.	Description	Width	Size	Qty
FECEW900G	Extra Wide Cover Strip Gold	57mm	0.9m	10
FECEW900S	Extra Wide Cover Strip Silver	57mm	0.9m	10
FEEW1800G	Extra Wide Cover Strip Gold	57mm	1.8m	5
FEEW1800S	Extra Wide Cover Strip Silver	57mm	1.8m	5

## Carpet Edging Thresholds

- This profile is designed to fix and protect a carpet where it is not joined to another carpet



Item No.	Description	Width	Size	Qty
FECE900G	Carpet Edging Gold	13mm	0.9m	10
FECE900S	Carpet Edging Silver	13mm	0.9m	10
FECE1800G	Carpet Edge Gold	13mm	1.8m	5
FECE1800S	Carpet Edge Silver	13mm	1.8m	5

## Step Edge Thresholds

- This profile is designed to provide a neat square finish to wood and laminate flooring



Item No.	Description	Width	Size	Qty
VHSE1800G	Wood Flooring Step Edge Gold	15mm	1.8m	10
VHSE1800S	Wood Flooring Step Edge Silver	15mm	1.8m	10



## CARPET TILES

Vitrex Carpet Tiles are quick and easy to install and ensure safety and environmental protection.

They are anti-slip, reduce noise, protect the floor and at the same time they are easy to clean and maintain.

There is no need to worry about spillages as you can easily remove and replace a damaged tile without difficulty.

You can also create a unique two tone style or lay single colour tiles, the choice is endless.

This product is convenient to fix and can be removed at any time.

- Quick and easy to fit and replace
  - Soft underfoot
  - Hardwearing and easy to clean
  - Value range features hardwearing loop pile
  - Premium range features a luxurious cut pile
- Base Material - Synthetic  
Coverage (sqm) - 0.25



[sales@qep.com](mailto:sales@qep.com) | 01283 245430

Vitrex  | 19



# CARPET TILES

## CT500 | Value Carpet Tile

- Beige 50 x 50cm



Item No.	Description	Qty
CT500	Value Carpet Tile - Beige	20

## CT502 | Value Carpet Tile

- Navy 50 x 50cm



Item No.	Description	Qty
CT502	Value Carpet Tile - Navy	20

## CT503 | Value Carpet Tile

- Grey 50 x 50cm



Item No.	Description	Qty
CT503	Value Carpet Tile - Grey	20

## CT504 | Value Carpet Tile

- Brown 50 x 50cm



Item No.	Description	Qty
CT504	Value Carpet Tile - Brown	20



# CARPET TILES

## CT610 | Premium Carpet Tile

- Features a luxurious cut pile
- Cream 50 x 50cm



Item No.	Description	Qty
CT610	Premium Carpet Tile - Cream	20

## CT611 | Premium Carpet Tile

- Features a luxurious cut pile
- Coffee 50 x 50cm



Item No.	Description	Qty
CT611	Premium Carpet Tile - Coffee	20

## CT612 | Premium Carpet Tile

- Features a luxurious cut pile
- Silver 50 x 50cm



Item No.	Description	Qty
CT612	Premium Carpet Tile - Silver	20

## CT613 | Premium Carpet Tile

- Features a luxurious cut pile
- Plum 50 x 50cm



Item No.	Description	Qty
CT613	Premium Carpet Tile - Plum	20



# CARPET TILES

## CT614 | Premium Carpet Tile

- Features a luxurious cut pile
- Blue 50 x 50cm



Item No.	Description	Qty
CT614	Premium Carpet Tile - Blue	20

## CT615 | Premium Carpet Tile

- Features a luxurious cut pile
- Teal 50 x 50cm



Item No.	Description	Qty
CT615	Premium Carpet Tile - Teal	20

## CT616 | Premium Carpet Tile

- Features a luxurious cut pile
- Red 50 x 50cm



Item No.	Description	Qty
CT616	Premium Carpet Tile - Red	20

## CT617 | Premium Carpet Tile

- Features a luxurious cut pile
- Charcoal 50 x 50cm



Item No.	Description	Qty
CT617	Premium Carpet Tile - Charcoal	20



# MERCHANDISING

Vitrex has a complete range of merchandising methods to help display the Flooring Tools Range attractively and encourage sales.

Select from display stands that maximise retail space and/or FSDUs which are ideal for fast selling promotional lines.



## 1 Metre Stand



Item No.	Description	Qty
1MSTAND	1 Metre Stand	1
1MLIGHT	1 Metre Lightbox	1
1MVITREX	1 Metre Vitrex Header	1

## Scotia FSDU Stand

- Holds 8 single facing or 4 double facing Threshold SKUs



Item No.	Description	Qty
SCOFSDUSTAND	Scotia FSDU Stand	1

## Pro Flooring Installation Kit FSDU Stand

- Holds 32 items



Item No.	Description	Qty
PROINSTSTAND	Pro Flooring Installation Kit FSDU Stand	1

**Vitrex**   
 Sign of a professional job



[www.krausflooring.co.uk](http://www.krausflooring.co.uk)





[www.xpsfoam.co.uk](http://www.xpsfoam.co.uk)



[www.robertsfit.co.uk](http://www.robertsfit.co.uk)



 The Maltsters, Wetmore Road, Burton Upon Trent DE1 4 1LS, UK  
 T: +44 (0) 1283 245 430 F: +44 (0) 1283 245 431  
 [sales@qep.com](mailto:sales@qep.com)  
 [www.vitrex.co.uk](http://www.vitrex.co.uk)



THE WORLD'S LEADING SUPPLIER OF TILING & FLOORING INSTALLATION EQUIPMENT