



SAFELINE

SAFELINE



INGCO

Make The World In Your Hands

2022 PRICE LIST

2022 PRICE LIST - UPDATE OCT 22

FREE **INGCO** STAND

*WHEN YOU PURCHASE €500 WORTH OR MORE



PROMO HATS AND BROLLYS AVAILABLE



SNAP-OFF BLADE KNIFE



12PC
DISPLAY CARTON



CODE: IHKNS11807



UTILITY KNIFE



12PC
DISPLAY CARTON



CODE: IHKNS11615



PRODUCT NAME& CODE:

**FOLDING KNIFE ALUMINUM ALLOY
HANDLE 61X19MM W/ 5PCS BLADES
CODE: IHUK6236 / IHUK6138**

PRICE



NEW 09/2022

PRODUCT NAME& CODE:

**FOLDING KNIFE 5 BLADES
CODE: IHUK6138**

PRICE

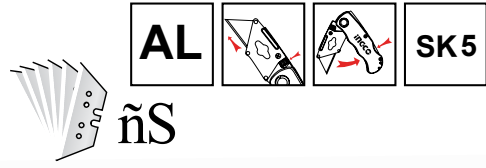

NEW 12/2021

PRODUCT NAME& CODE:

**UTILITY KNIFE SK5 BLADE WITH
6 BLADES
CODE: IHUK618**

PRICE



PRODUCT NAME& CODE:

**UTILITY KNIFE SK5 BLADE WITH
5 BLADES
CODE: IHUK6118**

PRICE



PRODUCT NAME& CODE:

**SNAP OFF KNIFE
CODE: IHKNS18068**

PRICE



NEW 01/2022

PRODUCT NAME& CODE:

**UTILITY KNIFE 5 BLADES
CODE: IHUK614**

PRICE



PRODUCT NAME& CODE:

**UTILITY KNIFE
CODE: IHUK615**

PRICE



PRODUCT NAME& CODE:

PRICE

SNAP OFF KNIFE
CODE: IHKNS16518



PRODUCT NAME& CODE:

PRICE

10PCS UTILITY KNIFE BLADE SET
CODE: IHUKB61001 / IHUKB611



PRODUCT NAME& CODE:

PRICE

10 PCS UTILITY KNIFE BLADE SET
CODE: IHKNSB181

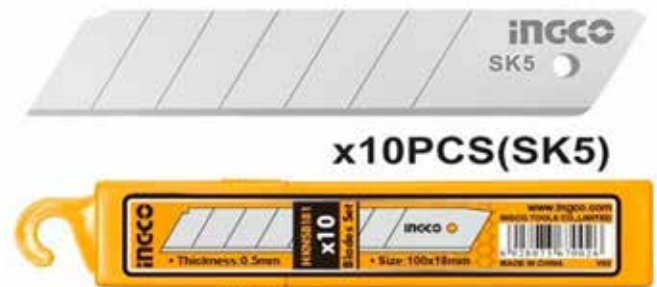

NEW 01/2022

PRODUCT NAME& CODE:

PRICE

130 MM LENGTH GLASS CUTTER
CODE: IHGCT02



PRODUCT NAME& CODE:

PRICE

178 MM LENGTH HEAVY DUTY GLASS CUTTER
CODE: IHGCT03



PRODUCT NAME& CODE:

PRICE

250MM AVIATION SNIPS
CODE: IHTSN0110S



PRODUCT NAME& CODE:

PRICE

215MM (8.5 INCHES) SCISSORS
CODE: IHSCRS812001



PRODUCT NAME& CODE:

PRICE

600MM TILE CUTTER
CODE: IHTC04600

PRODUCT NAME& CODE:

PRICE

800MM TILE CUTTER
CODE: IHTC04800

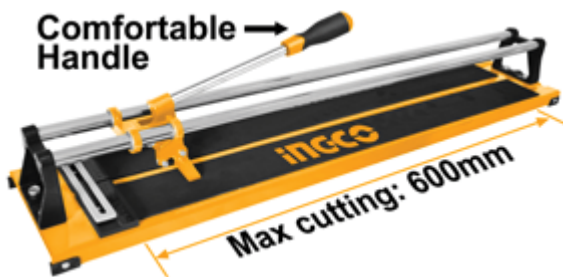

PRODUCT NAME& CODE:

PRICE

METAL SCRAPER WITH 6PCS SK5 KNIFE BLADE
CODE: IHGS3008 / IHGS3201



5PCS

100mm

300mm



NEW 09/2022

PRODUCT NAME& CODE:

PRICE

200MM SLOTTED
CODE: IHS288200



PRODUCT NAME& CODE:

PRICE

INGCO 15PC SCREWDRIVER BITS
DISPLAY
CODE: IAKSD0151



PRODUCT NAME& CODE:

PRICE

13 IN 1 RATCHETSCREWDRIVER SET
CODE: IAKISD1208



PRODUCT NAME& CODE:

PRICE

6 IN 1 SCREWDRIVER SET 2PCS
X 2 WAY
CODE: IAKISD0608



TWO-WAY BIT
6.35X 65MM, PH1+SL5
8.00X 75MM, PH2+SL6
SOCKET: 6MM, 8MM

PRODUCT NAME& CODE:

PRICE

2 PCS GO THROUGH SET SL65X100
PH2X100
CODE: IHSGT280208 / IHSGT680208

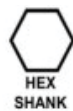

PRODUCT NAME& CODE:

PRICE

26 PCS SCREWDRIVER BIT SET
CODE: IHKSD0268



PRODUCT NAME& CODE:

PRICE

**4.0MM X 100MM SLOTTED
SCREWDRIVER**
CODE: IHS284100

PRODUCT NAME& CODE:

PRICE

**5.5MM X 75MM SLOTTED
SCREWDRIVER**
CODE: IHS285075 / IHS685075

PRODUCT NAME& CODE:

PRICE

**5.5MM X 100MM SLOTTED
SCREWDRIVER**
CODE: IHS285100

PRODUCT NAME& CODE:

PRICE

**6.5MM X 150MM SLOTTED
SCREWDRIVER**
CODE: IHS286150



Cr-V



PRODUCT NAME& CODE:

PRICE

**8.0MM X 200MM SLOTTED
SCREWDRIVER**
CODE: IHS688200

PRODUCT NAME& CODE:

PRICE

**38MM STUBBY SLOTTED
SCREWDRIVER 6.5MM**
CODE: IHS282038 / IHS686038

PRODUCT NAME& CODE:

PRICE

**38MM STUBBY SLOTTED
SCREWDRIVER 6.0MM**
CODE: IHS28PH2038



PRODUCT NAME& CODE:

PRICE

**8.0MM X 200MM SLOTTED
SCREWDRIVER**
CODE: IHS688200



SL8x200

S2



Cr-V



PRODUCT NAME& CODE:

SLOTTED SCREWDRIVER 5.5MM X
100MM S2, ROUND SHANK
CODE: IHS685100

PRICE



NEW 09/2022

PRODUCT NAME& CODE:

PHILLIPS SCREWDRIVER 6.0MM X
125MM S2,PH2, ROUND SHANK
CODE: IHS68PH2038

PRICE



NEW 09/2022

PRODUCT NAME& CODE:

PHILLIPS SCREWDRIVER 6.0MM X
38MM S2,PH2, ROUND SHANK
CODE: IHS68PH2125

PRICE

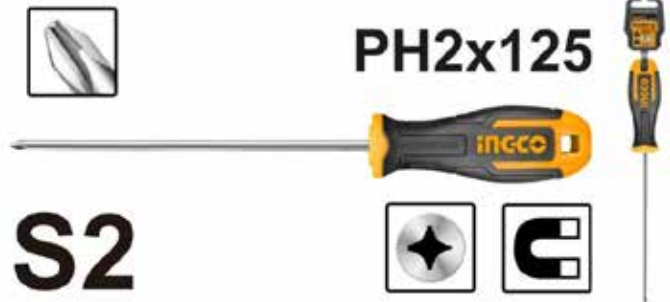

PRODUCT NAME& CODE:

2PCS GO-THROUGH SCREWDRIVER
SET S2 INDUSTRIAL STEEL HEX
CODE: IHS68PH2028

PRICE

NEW 09/2022

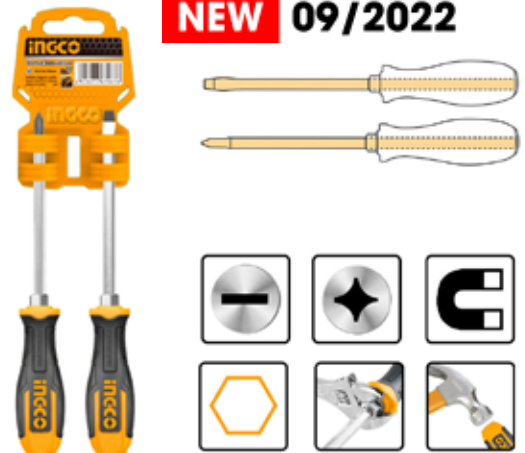

PRODUCT NAME& CODE:

**5.0MM X 100MM T10 TORX
SCREWDRIVER**
CODE: IHS28T10100

PRICE

PRODUCT NAME& CODE:

**INGCO 6.0MM X 150MM T20
TORX SCREWDRIVER**
CODE: IHS28T20150

PRICE



PRODUCT NAME& CODE:

**2 PCS SCREWDRIVER SET SL65X100
PH2X100 SCREW DRIVER**
CODE: IHKSD0248

PRICE

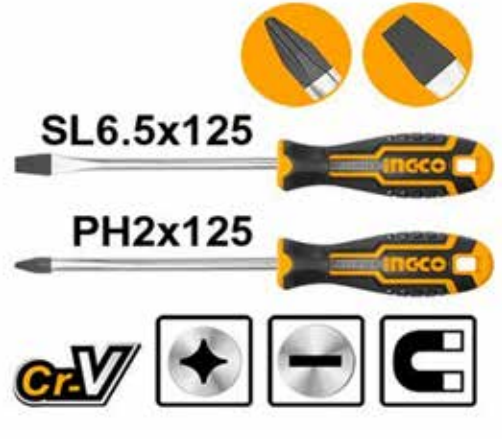

PRODUCT NAME& CODE:

**6.0MM X 125MM PHILLIP NO.2
SCREWDRIVER**
CODE: IHS28PH2125

PRICE



PRODUCT NAME& CODE:

8 PCS RATCHET SCREWDRIVER SET
CODE: IAKISD0808

PRICE



- SL5,SL6
- PH1,PH2,PH3
- T15,T20



PRODUCT NAME& CODE:

PHILLIPS SCREWDRIVER
CODE: IHS68PH1075

PRICE



PRODUCT NAME& CODE:

14PCS SCREWDRIVER SET
CODE: IHKSD1828

PRICE



NEW 01/2022

PRODUCT NAME& CODE:

PRICE

6PCS GO- THROUGH SCREWDRIVER SET
CODE: IHSGT680608



PRODUCT NAME& CODE:

PRICE

33PCS SCREWDRIVER SET
CODE: IHKSD0338



PRODUCT NAME& CODE:

PRICE

10PCS SCREWDRIVER SET
CODE: IHKSD1028



PRODUCT NAME& CODE:

PRICE

30PC SCREWDRIVER BITS DISPLAY
CODE: IAKSD08301



NEW 01/2022

PRODUCT NAME& CODE:

PRICE

6PCS SCREWDRIVER SET
CODE: IHKSD0628



PRODUCT NAME& CODE:

PRICE

32PC PRECISION SCREWDRIVER SET
CODE: IHKSD0348



NEW 12/2021

PRODUCT NAME& CODE:

PRICE

10 PCS INSULATED HAND TOOLS SET
SET
CODE: IHKT01S101



PRODUCT NAME& CODE:

PRICE

3PCS INSULATED PLIERS SET
CODE: IHKISD0308



NEW 01/2022

PRODUCT NAME& CODE:

PRICE

18PCS T- HANDLE WRENCH SCREWDRIVER SET
CODE: IHKSDB0188



PRODUCT NAME& CODE:

PRICE

2 IN 1 SCREWDRIVER SET
6.35 X 160MM, PH2+SL6
CODE: IAKISD0201

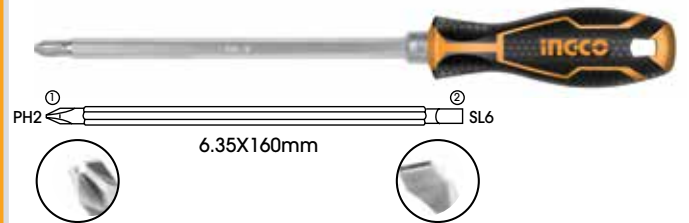
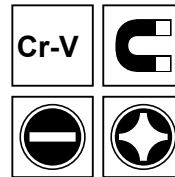

PRODUCT NAME& CODE:

PRICE

RATCHET HANDLE 24PCS SCREWDRIVER SET
CODE: IHKSDB0248



- SL3,SL4,SL5, SL6,SL6,SL7
- PH1,PH2,PH2,PH3
- PZ1,PZ2
- T10,T15,T20,T25

7Pcs 1/4" Power sleeve
5mm,6mm,7mm,8mm
9mm,10mm,11mm

Item No.	N (pc)
HK5DB0248	24



PRODUCT NAME& CODE:

PRICE

TRIANGLE STEEL FILE
CODE: IHSTF088



1pcs file with 1pcs plastic hanger

PRODUCT NAME& CODE:

PRICE

200MM FLAT FILE
CODE: IHSFF088

PRODUCT NAME& CODE:

PRICE

**INGCO 200MM FLAT WOOD FILE
SCREW DRIVER**
CODE: IHWFF088

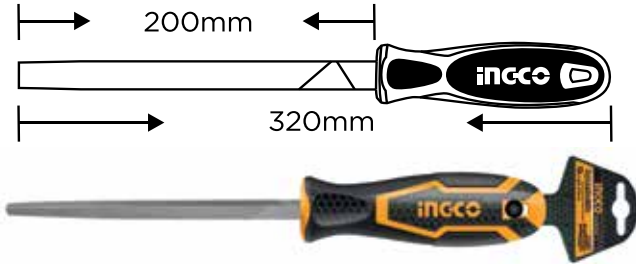

PRODUCT NAME& CODE:

PRICE

ROUND STEEL FILE
CODE: IHSRF088P



**1pcs file
with 1pcs plastic hanger**

PRODUCT NAME& CODE:

PRICE

200MM SQUARE STEEL FILE
CODE: IHSSF088

PRODUCT NAME& CODE:

PRICE

HALF ROUND STEEL FILE
CODE: IHSHF088



**1pcs file
with 1pcs plastic hanger**

PRODUCT NAME& CODE:

PRICE

5PC STEEL FILE SET 200MM
CODE: IHKTF5058

ROUND, HALF
ROUND,
TRIANGLE, FLAT,
SQUARE



PRODUCT NAME& CODE:

PRICE

6PC FILE SET (140 LENGTH)
CODE: IHKTF63



PRODUCT NAME& CODE:

PRICE

**10PCS X50MM PHILLIPS
SCREWDRIVER BITS
CODE: ISDB11PH223**



PRODUCT NAME& CODE:

PRICE

**13PCS FLAT WOOD DRILL BITS SET
CODE: IAKD41301**



PRODUCT NAME& CODE:

PRICE

**10PCS X50MM POZI NO.2
SCREWDRIVER BITS
CODE: ISDB11PZ223**



PRODUCT NAME& CODE:

PRICE

**9 PCS INTERCHANGABLE
SCREWDRIVER SET
CODE: IAKISD0901**



PRODUCT NAME& CODE:

PRICE

**12PCS HSS TWIST DRILL BIT
SET 2.0-8.0MM
CODE: IAKDB1125**



PRODUCT NAME& CODE:

PRICE

**SCREWDRIVER BIT HOLDER
WITH RELEASE
CODE: IABH20601**



PRODUCT NAME& CODE:

PRICE

5.0 PHILLIP NO.1 SCREWDRIVER
75MM
CODE: IHS28PH1075

PRODUCT NAME& CODE:

PRICE

5.0 PHILLIP NO.1 SCREWDRIVER
75MM
CODE: IHS28PH1075

PRODUCT NAME& CODE:

PRICE

5.0 PHILLIP NO.1 SCREWDRIVER
100MM
CODE: IHS28PH1100

PRODUCT NAME& CODE:

PRICE

5.0 PHILLIP NO.1 SCREWDRIVER
100MM
CODE: IHS68PH1100



PRODUCT NAME& CODE:

PRICE

14PCS SCREWDRIVER SET
CODE: IHKSD1428



NEW 01/2022

PRODUCT NAME& CODE:

PRICE

6PC INSULATED SCREWDRIVER SET
1000V PROTECTION
CODE: IHKISD0608



FLAT HEAD 3 X 75, 5 X 100, 5 X 150

PHILLIPS 2 X 125, 1 X 100, 0 X 75

PRODUCT NAME& CODE:

PRICE

NO.1 INSULATED SCREWDRIVERS
4.0 X 100MM
CODE: IHISD814100

PRODUCT NAME& CODE:

PRICE

NO.3 INSULATED SCREWDRIVERS
6.5 X 150MM
CODE: IHISD816150

PRODUCT NAME& CODE:

PRICE

NO.5 INSULATED SCREWDRIVERS
POZI NO.2X100
CODE: IHISD81PZ2100

PRODUCT NAME& CODE:

PRICE

NO.2 INSULATED SCREWDRIVERS
5.5 X 125MM
CODE: IHISD815125

PRODUCT NAME& CODE:

PRICE

NO.4 INSULATED SCREWDRIVERS
PHILIPS NO.2X100
CODE: IHISD81PH2100

PRODUCT NAME& CODE:

PRICE

NO.6 INSULATED SCREWDRIVERS
3.0 X 75MM
CODE: IHISD813075



PRODUCT NAME& CODE:

PRICE

**HIGH LEVERAGE HEAVY-DUTY
DIAGONAL CUTTING PLIERS
CODE: IHHDPC28180**



PRODUCT NAME& CODE:

PRICE

**160MM HIGH LEVERAGE LONG
NOSE PLIERS
CODE: IHHLNP28160**



PRODUCT NAME& CODE:

PRICE

**180MM COMBINATION PLIER
CODE: IHCP08188**



PRODUCT NAME& CODE:

PRICE

**200MM COMBINATION PLIER
CODE: IHCP08208**



PRODUCT NAME& CODE:

PRICE

**160MM COMBINATION PLIER CVR
HANDLE
CODE: IHCP28168**



PRODUCT NAME& CODE:

PRICE

**200MM COMBINATION PLIER CVR
HANDLE
CODE: IHCP28208**



PRODUCT NAME& CODE:

PRICE

**200MM HIGH LEVERAGE
COMBINATION PLIER
CODE: IHHC28200**



PRODUCT NAME& CODE:

PRICE

**180MM DIAGONAL PLIER
CODE: IHDCP28180**





PRODUCT NAME& CODE: 160MM DIAGONAL PLIER CVR HANDLE CODE: IHDCP28168	PRICE	
PRODUCT NAME& CODE: 180MM DIAGONAL PLIER CVR HANDLE CODE: IHDCP28188	PRICE	



PRODUCT NAME& CODE: 300MM WATERPUMP PLIER CVR TPR HANDLE CODE: IHPP03300	PRICE	
PRODUCT NAME& CODE: 250MM WATERPUMP PLIER CVR TPR HANDLE CODE: IHPP28250	PRICE	

PRODUCT NAME& CODE: 250MM WATERPUMP PLIER CVR TPR HANDLE CODE: IHPP28258	PRICE	
---	--------------	--

PRODUCT NAME& CODE: 3PCS HIGH LEVERAGE PLIER SET CODE: IHKHLPS2831	PRICE	 
---	--------------	--



Normal Pliers



High Leverage Pliers

Long arm of force to save 30% strength .

PRODUCT NAME& CODE: INDUSTRIAL BOLT CUTTER CRV 300MM MAX DIA (Ø): 5MM CODE: IHBC0812	PRICE
PRODUCT NAME& CODE: INDUSTRIAL BOLT CUTTER CRV 350MM MAX DIA (Ø): 7MM CODE: IHBC0814	PRICE
PRODUCT NAME& CODE: INDUSTRIAL BOLT CUTTER CRV 450MM MAX DIA (Ø): 8MM CODE: IHBC0818	PRICE
PRODUCT NAME& CODE: INDUSTRIAL BOLT CUTTER CRV 600MM MAX DIA (Ø): 10MM CODE: IHBC0824	PRICE
PRODUCT NAME& CODE: INDUSTRIAL BOLT CUTTER CRV 760MM MAX DIA (Ø): 13MM CODE: IHBC0830	PRICE

PRODUCT NAME& CODE: INDUSTRIAL BOLT CUTTER CRV 915MM MAX DIA (Ø): 16MM CODE: IHBC0836	PRICE
PRODUCT NAME& CODE: INDUSTRIAL BOLT CUTTER CRV 1050MM MAX DIA (Ø): 19MM CODE: IHBC0842	PRICE

Cr-V



Comfortable Rubber Handle

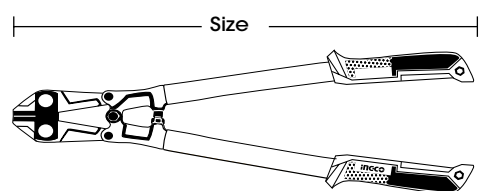

PRODUCT NAME& CODE:

180MM HIGH LEVERAGE DIAGONAL PLIERS
CODE: IHHLDCP28180

PRICE



PRODUCT NAME& CODE:

200MM LEVERAGE LONG NOSE PLIERS
CODE: IHHLNP28200

PRICE



PRODUCT NAME& CODE:

160MM LEVERAGE LONG NOSE PLIERS
CODE: IHLNP28168

PRICE



PRODUCT NAME& CODE:

250MM CABLE CUTTER
CODE: IHCCB0210

PRICE



Copper and aluminum cables



PRODUCT NAME& CODE:

160MM DIAGONAL PLIERS
CODE: IHDCP08168

PRICE



PRODUCT NAME& CODE:

250MM INDUSTRIAL PIPE WRENCH
CODE: IHPW0810

PRICE

PRODUCT NAME& CODE:

300MM INDUSTRIAL PIPE WRENCH
CODE: IHPW0812

PRICE

PRODUCT NAME& CODE:

350MM INDUSTRIAL PIPE WRENCH
CODE: IHPW0814

PRICE

PRODUCT NAME& CODE:

450MM INDUSTRIAL PIPE WRENCH
CODE: IHPW0818

PRICE

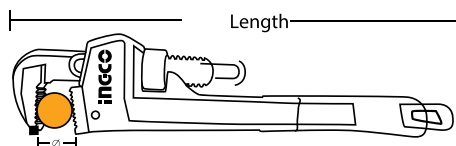

Item No.	Length	Max Ø (mm)
HPW0810	10"	34



PRODUCT NAME& CODE:

PRICE

3PCS INSULATED PLIERS SET
CODE: IHKPS28318



Cr-V



NEW 01/2022

PRODUCT NAME& CODE:

PRICE

180MM INSULATED COMBINATION
PLIERS 1000V
CODE: IHICP01200

PRODUCT NAME& CODE:

PRICE

180MM INSULATED COMBINATION
PLIERS 1000V
CODE: IHICP28188



NEW 12/2021

PRODUCT NAME& CODE:

PRICE

200MM INSULATED LONG NOSE
PLIERS 1000V
CODE: IHILNP28208

PRODUCT NAME& CODE:

PRICE

180MM LOCKING PLIER
CODE: IHCJLW0207



NEW 12/2021

Cr-V



PRODUCT NAME& CODE:

PRICE

180MM SEAL PLIERS
CODE: IHSP0107

PRODUCT NAME& CODE:

PRICE

250MM STRAIGHT JAW LOCKING
PLIER
CODE: IHSJP0110

PRODUCT NAME& CODE:

PRICE

250MM STRAIGHT JAW LOCKING
PLIER
CODE: IHSJP0210



Cr-V



PRODUCT NAME& CODE:

PRICE

450G/16OZ ALL STEEL CLAW
HAMMER 1PCS
CODE: IHCH8816

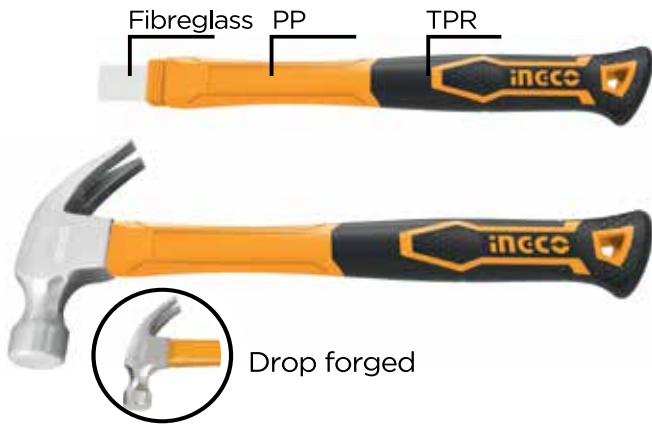

PRODUCT NAME& CODE:

PRICE

CLAW HAMMER
CODE: IHCH80816



PRODUCT NAME& CODE:

PRICE

1130G ALL STEEL STONING
HAMMER
CODE: IHSTH0825



PRODUCT NAME& CODE:

PRICE

SLEDGE HAMMER(CONVERSE
HANDLE)
CODE: IHSM01108D



PRODUCT NAME& CODE:

PRICE

600G FIBREGLASS HANDLE AXE
CODE: IHAX0206008

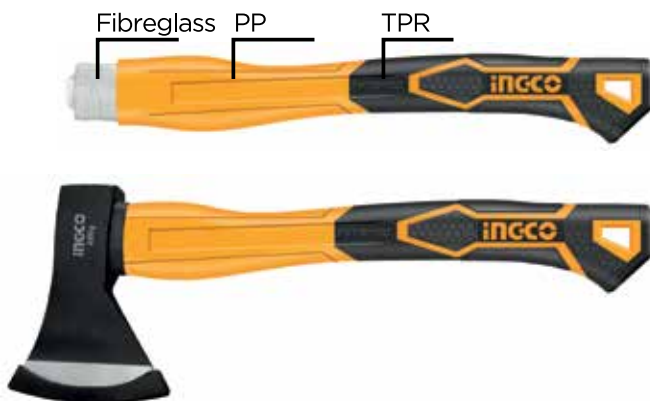

PRODUCT NAME& CODE:

PRICE

1000G FIBREGLASS HANDLE AXE
CODE: IHAX02010008

PRODUCT NAME& CODE:

PRICE

12500G FIBREGLASS HANDLE AXE
CODE: IHAX02012508



PRODUCT NAME& CODE:

PRICE

150MM ADJUSTABLE WRENCH
CODE: IHADW131068

PRODUCT NAME& CODE:

PRICE

200MM ADJUSTABLE WRENCH
CODE: IHADW131088

PRODUCT NAME& CODE:

PRICE

250MM ADJUSTABLE WRENCH
CODE: IHADW131108

PRODUCT NAME& CODE:

PRICE

300MM ADJUSTABLE WRENCH
CODE: IHADW131128

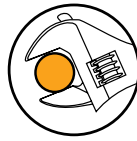

wide opening

PRODUCT NAME& CODE:

PRICE

215MM WIRE STRIPPER
CODE: IHWSP851



for cutting wir
Push dow
wire functio

Sharp edge
for cutting wire
Multilocation for reel
wire high precise
design of milling dege

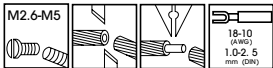

PRODUCT NAME& CODE:

PRICE

80Z RUBBER MALLET FIBREGLASS HANDLE
CODE: IHRUH8308

PRODUCT NAME& CODE:

PRICE

160Z RUBBER MALLET FIBREGLASS HANDLE
CODE: IHRUH8316

Fibreglass

PP

TPR



Soft type

PRODUCT NAME& CODE:

PRICE

160Z/450G CLAW HAMMER
WOODEN HANDLE
CODE: IHCH0416



Hardwood handle

Forged carbon steel head hard and tempered

Safety protection steel ring



PRODUCT NAME& CODE:

PRICE

25PC 1/2" SOCKET SET
CODE: IHKTS12251



PRODUCT NAME& CODE:

PRICE

600G ALL STEEL ROOFING HAMMER
CODE: IHRH6008 / IHRH60028



Overall forged

Anti-shock handl

PRODUCT NAME& CODE:

PRICE

16 OZ ALL STEEL CLAW HAMMER
CODE: IHCH8816



Overall forged

Anti-shock handl

PRODUCT NAME& CODE:

PRICE

200 OZ ALL STEEL CLAW HAMMER
CODE: IHCH8820

PRODUCT NAME& CODE:

PRICE

1000G FIBREGLASS STONING HAMMER
CODE: IHSTH8802

PRODUCT NAME& CODE:

PRICE

1500G FIBREGLASS STONING HAMMER
CODE: IHSTH8803

PRODUCT NAME& CODE:

PRICE

2000G FIBREGLASS STONING HAMMER
CODE: IHSTH8804



Drop forged

Fibreglass PP

TPR



PRODUCT NAME& CODE:

PRICE

10LB FIBREGLASS HANDLE SLEDGE
CODE: IHSM01498

PRODUCT NAME& CODE:

PRICE

12LB FIBREGLASS HANDLE SLEDGE
CODE: IHSM01598



Forged carbon steel head hardened and tempered

PRODUCT NAME& CODE:
300MM TENNON (BACK) SAW
CODE: IHMBSB3008

PRICE



PRODUCT NAME& CODE:
44.0MM X 215MM MASONRY CHISEL
CODE: IHCL844410

PRICE

PRODUCT NAME& CODE:
76.0MM X 215M MASONRY CHISEL
CODE: IHCL837610

PRICE



PRODUCT NAME& CODE:
300MM ADJ HACKSAW FRAME
CODE: IHHF3028

PRICE

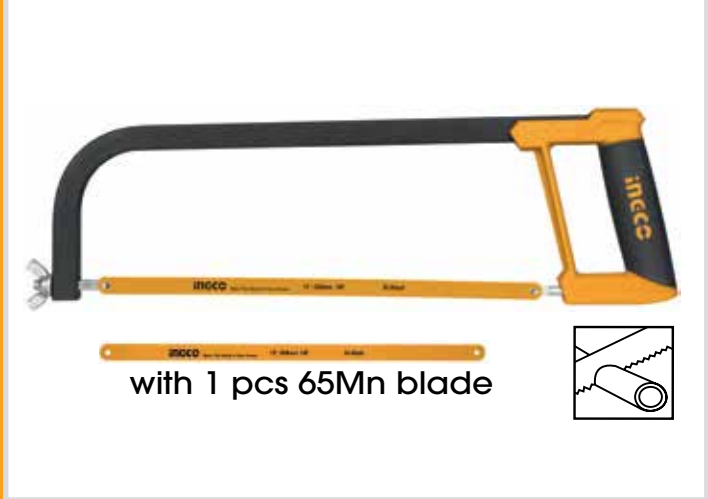

PRODUCT NAME& CODE:
MITRE BOX
CODE: IHMBS3008

PRICE



PRODUCT NAME& CODE:
PRUNING SAW
CODE: IHPS3008

PRICE



PRODUCT NAME& CODE:
300MM INDUSTRIAL HACKSAW FRAME
CODE: IHHF3008

PRICE



PRODUCT NAME& CODE:

PRICE

150MM WALL BOARD SAW SK5
CODE: IHWSW68



PRODUCT NAME& CODE:

PRICE

180MM FOLDING HAND SAW
CODE: IHFSW1808



PRODUCT NAME& CODE:

PRICE

300MM LENGTH 7 TPI COMPAS SAW
CODE: IHCS3008



PRODUCT NAME& CODE:

PRICE

550MM HANDSAW
CODE: IHHAS08550

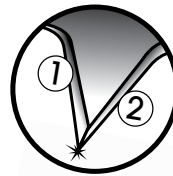

PRODUCT NAME& CODE:

PRICE

BOW SAW
CODE: IHBS6101



PRODUCT NAME& CODE:

280MMX 130MM SERRATED
PLASTERING TROWEL; TEETH 10X10MM
CODE: IHPTT28138

PRICE

INGCO unique design handle



PRODUCT NAME& CODE:

280MMX 130MM PLASTERING
TROWEL
CODE: IHPT28138

PRICE

INGCO unique design handle



PRODUCT NAME& CODE:

280MMX 130MM STAINLESS STEEL
SERRATED
CODE: IHPTT28138S

PRICE

INGCO unique design handle



Stainless steel blade

PRODUCT NAME& CODE:

280MMX 130MM STAINLESS STEEL
CODE: IHPT28138S

PRICE

INGCO unique design handle



Stainless steel blade

PRODUCT NAME& CODE:

PRICE

8 PCS T HANDLE HEX WRENCH SET
CODE: IHHT0081



PRODUCT NAME& CODE:

PRICE

9PCS CVR HEX KEY SET;
SIZE 1.5 -10MM
CODE: IHHK11091

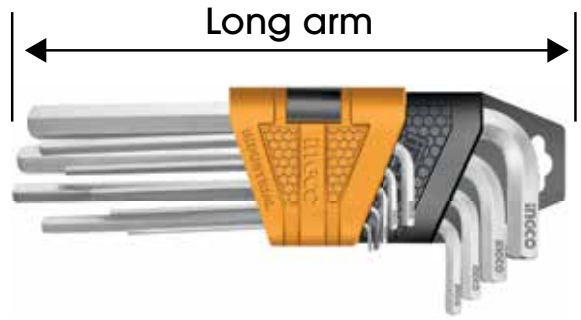
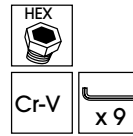

PRODUCT NAME& CODE:

PRICE

9PCS CVR BALL POINT HEX KEY SET
CODE: IHHK12092



PRODUCT NAME& CODE:

PRICE

BALL HEX KEY SET; SIZE 2-8MM
CODE: IHHK14082



PRODUCT NAME& CODE:

PRICE

HEX KEY FOLDING SET; SIZE 2-8MM
CODE: IHHK14081

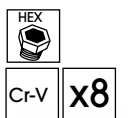

PRODUCT NAME& CODE:

PRICE

HEX KEY FOLDING SET; SIZE 2-8MM
CODE: IHHK14083

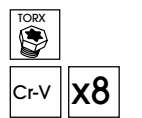

PRODUCT NAME& CODE:	PRICE
COMBINATION SPANNER SET 6.0MM 19.0MM CODE: IHKSPA1088	

PRODUCT NAME& CODE:	PRICE
COMBINATION SPANNER SET 6.0MM 22.0MM CODE: IHKSPA2088	



PRODUCT NAME& CODE:	PRICE
11 PCS HOUSEHOLD TOOLS SET CODE: IHKTV01H111	



PRODUCT NAME& CODE:	PRICE
25PCS HANDTOOL SET CODE: IHKTH10258	



PRODUCT NAME& CODE:	PRICE
1/2 RATCHET WRENCH CODE: IHRTH0812	

PRODUCT NAME& CODE:	PRICE
1/4 RATCHET WRENCH CODE: IHRTH0814	

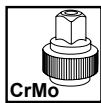

PRODUCT NAME& CODE:	PRICE
250MM DRYWALL TAPING KNIFE CODE: IHPUT78250	



PRODUCT NAME& CODE:

PRICE

12PC X 1/2 SOCKET SET
CODE: IHKTS12122



DIN 3122	DIN 3123	DIN 3124
1/2"	Cr-V 50BV30	72T



PRODUCT NAME& CODE:

PRICE

45 PCS X 1/4 SOCKET SET, SOCKET 4 -14MM
CODE: IHKTS14451

DIN 3122	DIN 3124
DIN 3123	1/4"
Cr-V 50BV30	45T



PRODUCT NAME& CODE:

PRICE

60MM PUTTY TROWEL
CODE: IHPUT08040

PRODUCT NAME& CODE:

PRICE

60MM PUTTY TROWEL
CODE: IHPUT08060

PRODUCT NAME& CODE:

PRICE

80MM PUTTY TROWEL
CODE: IHPUT08080

PRODUCT NAME& CODE:

PRICE

100MM PUTTY TROWEL
CODE: IHPUT08100



Special blade

INGCO unique design



Special connection technology

Innovated by INGCO
Patent No.: ZL 2012 3 0011833.X

PRODUCT NAME& CODE:

PRICE

160MM BRICK TROWEL PLASTIC HANDLE
CODE: IHBT618

PRODUCT NAME& CODE:

PRICE

200MM BRICK TROWEL PLASTIC HANDLE
CODE: IHBT818



PRODUCT NAME& CODE:

PRICE

60MM MULTIFUNCTION PUTTY TROWEL
CODE: IHPUT08060M



PRODUCT NAME& CODE:

**50M X 12.5MM FIBREGLASS
MEASURING TAPE
CODE: IHFMT8250**

PRICE



PRODUCT NAME& CODE:

**DIGITAL DISPLAY MEASURING
WHEEL
CODE: IHDMW23**

PRICE

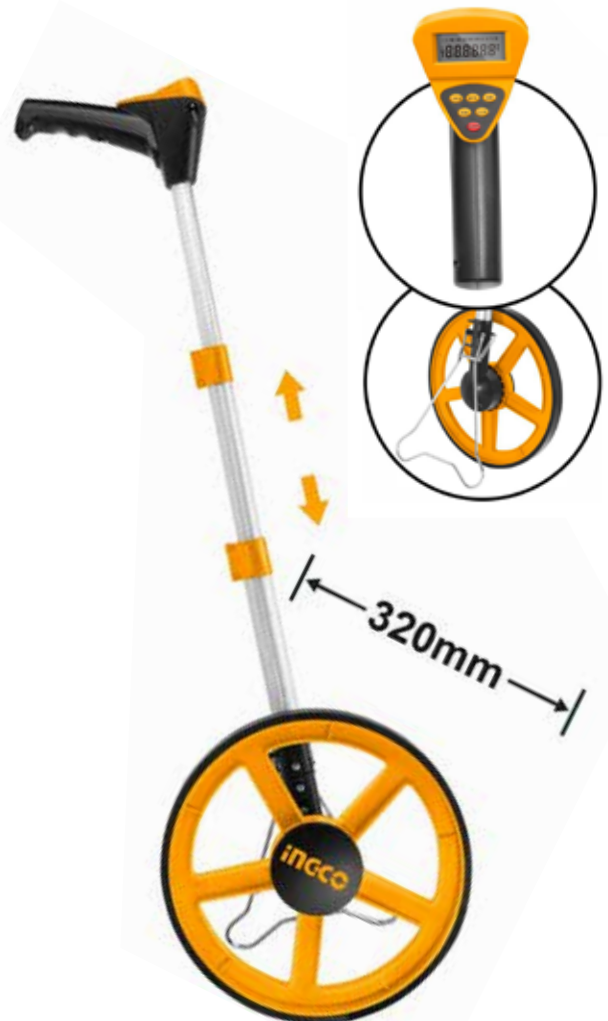

NEW 09/2022

PRODUCT NAME& CODE:

PRICE

**FIBREGLASS MEASURING TAPE
CODE: IHFMT8130**



PRODUCT NAME& CODE:

STEEL MEASURING TAPE
5MX19MM
CODE: IHSMT08519

PRICE

PRODUCT NAME& CODE:

STEEL MEASURING TAPE
5MX25MM
CODE: IHSMT08525

PRICE

PRODUCT NAME& CODE:

STEEL MEASURING TAPE
8MX25MM
CODE: IHSMT08825

PRICE

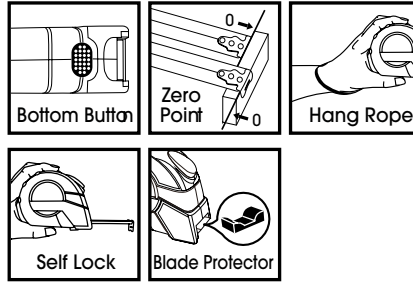

NEW 09/2022

PRODUCT NAME& CODE:

3 METRE X16 MM METRIC/IMPERIAL
CODE: IHSMT08316

PRICE

PRODUCT NAME& CODE:

10.0 METRE X 25.0MM
METRIC/IMPERIAL
CODE: IHSMT0810

PRICE

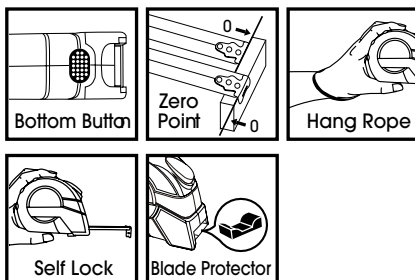

Metric and Inch

PRODUCT NAME& CODE:

CABLE STRIPPING KNIFE
CODE: IHPK82001

PRICE



NEW 12/2021

PRODUCT NAME& CODE:

POCKET KNIFE
CODE: IHPK01981

PRICE



PRODUCT NAME& CODE:

MULTI-FUNCTION KNIFE
CODE: IHMFK8158

PRICE



- Slotted screwdriver 8
- Large knife 1
- Fish scaler 9
- Can opener 2
- Hook remover 10
- Phillips screwdriver 3
- Saw 11
- Leather punch 4
- Corkscrew 12
- Bottle opener 5
- Nail cleaner 13
- Scissors 6
- Nail file 14
- Needle 7
- Key ring 15

PRODUCT NAME& CODE:

PLANNER BLADES 82 X 5.5 X 1.2
CODE: IEPB820121

PRICE



X2 HSS

PRODUCT NAME& CODE:

END CUTTERS 180MM
CODE: IHECP02180

PRICE



PRODUCT NAME& CODE:

PRICE

DOUBLE ROW CUP GRINDING WHEEL 18 TEETH
115MM X 22 STONE, CONCRETE, MASONRY
CODE: ICGW021151



PRODUCT NAME& CODE:

PRICE

DIAMOND CUP WHEELS TURBO ROW
CODE: ICGW011151



NEW 09/2022

PRODUCT NAME& CODE:

PRICE

610MM X 25M WRECKING BAR
CODE: IHWBA01242

PRODUCT NAME& CODE:

PRICE

350MM X 2200MM WRECKING BAR
CODE: IHWBA01142

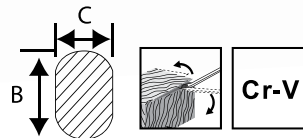

PRODUCT NAME& CODE:

PRICE

FOLDABLE MULTI FUNCTION TOOL
CODE: IHFMFT0115



PRODUCT NAME& CODE:

PRICE

900MM X 25MM WRECKING BAR
CODE: IHWBA01362

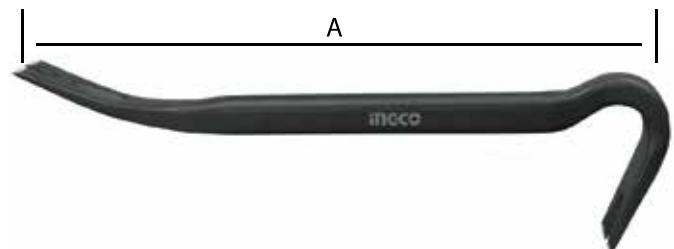

PRODUCT NAME& CODE:

PRICE

TOOL BAG 16"
CODE: IHTBGL01



PRODUCT NAME& CODE:

PRICE

TOOL BAG 24"
CODE: IHTBG04



PRODUCT NAME& CODE:

PRICE

495MM X 200MM X 290MM
TOOLBOX
CODE: IHTB02



PRODUCT NAME& CODE:

PRICE

TOOL BAG 13"
CODE: IHTBG05



PRODUCT NAME& CODE:

2 TON BOTTLE JACK C/W SAFETY VALVE
CODE: IHBJ202

PRICE



PRODUCT NAME& CODE:

2 TON FLOORHYDRAULIC JACK
CODE: IHFJ201

PRICE



PRODUCT NAME& CODE:

6.0WOOD CHISEL CRVE
CODE: IHWC0806

PRICE

PRODUCT NAME& CODE:

9.0WOOD CHISEL CRVE
CODE: IHWC0809

PRICE

PRODUCT NAME& CODE:

12.0 WOOD CHISEL CRVE
CODE: IHWC0812

PRICE

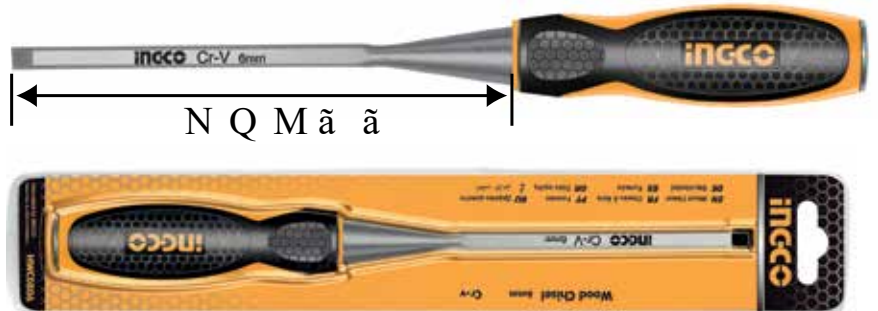

Cr-V

PRODUCT NAME& CODE:

14.0 WOOD CHISEL CRV
CODE: IHWC0814

PRICE

PRODUCT NAME& CODE:

16.0 WOOD CHISEL CRV
CODE: IHWC0816

PRICE

PRODUCT NAME& CODE:

19.0 WOOD CHISEL CRV
CODE: IHWC0819

PRICE

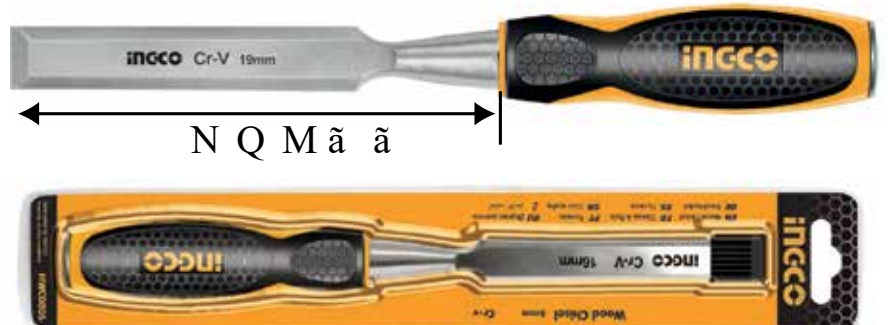

Cr-V

PRODUCT NAME& CODE:

PRICE

22.0 WOOD CHISEL CRV
CODE: IHWC0822

Cr-V

PRODUCT NAME& CODE:

PRICE

25.0 WOOD CHISEL CRV
CODE: IHWC0825

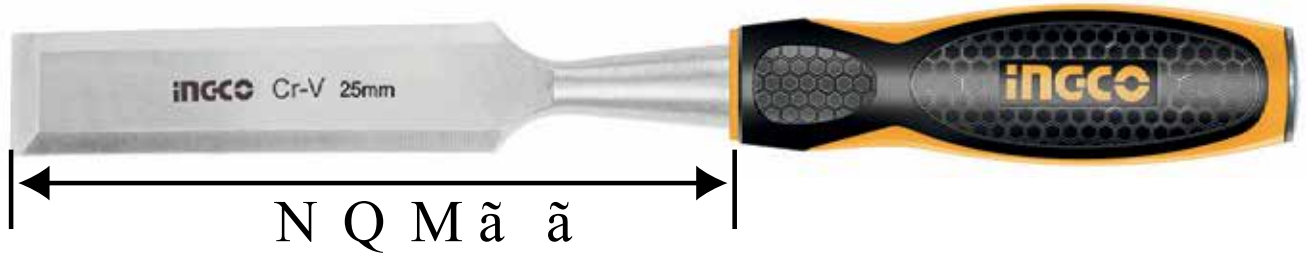
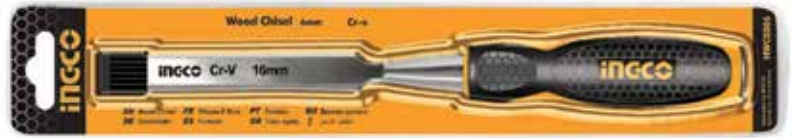

PRODUCT NAME& CODE:

PRICE

4PCS WOOD CHISEL SET
6,12,19,25 CRV
CODE: IHKTWC0401

Cr-V



PRODUCT NAME& CODE:

PRICE

HAND RIVETER 10.5"
CODE: IHR104



PRODUCT NAME& CODE:

PRICE

GREASE GUN 400CC
CODE: IGRG015002

PRODUCT NAME& CODE:

PRICE

INGCO FOLDING HAND RIVETER 815
CODE: IHFOR321



Rubber Handle



PRODUCT NAME& CODE:

PRICE

HAND RIVETER 260MM/10"
CODE: IHR101

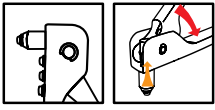

PRODUCT NAME& CODE:

PRICE

1500MM SPIRIT LEVEL
CODE: IHSL08150



NEW 01/2022

PRODUCT NAME& CODE:

PRICE

60CMS HEAVY DUTY MASONS SPIRIT LEVEL
CODE: IHBSL08060

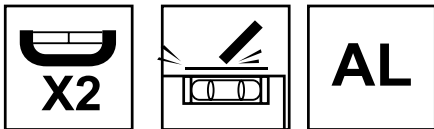
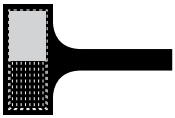

PRODUCT NAME& CODE:

PRICE

MAGNETIC LEVEL 60CM
CODE: IHSL38060M

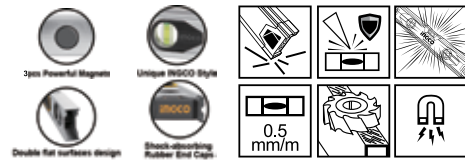

PRODUCT NAME& CODE:

PRICE

225MM MINI SPIRIT LEVEL
CODE: IHMSL01030

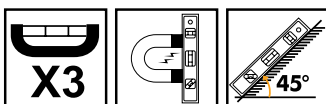





PRODUCT NAME& CODE:

PRICE



11.3MM X .07MM 4-14MM STAPLE GUN
CODE: IHSG1403



PRODUCT NAME& CODE:	PRICE
230MM PVC PIPE CUTTER CODE: IHPC0442	

PRODUCT NAME& CODE:	PRICE
3-32MM PIPE CUTTER WRENCH CODE: IHPC0232	

PRODUCT NAME& CODE:	PRICE
HEAVY DUTY SHUTTER LOCK 60MM CODE: IDBBPL0602	

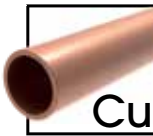
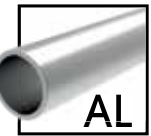
PRODUCT NAME& CODE:	PRICE
10.0 MMX W0.70MM STAPLES CODE: ISTS0412	

PRODUCT NAME& CODE:	PRICE
HEAVY DUTY SHUTTER LOCK 90MM CODE: IDBBPL0702	



Crown 6.3mm
Length 12mm
Width 1.2mm

NEW 01/2022

NEW 03/2022

PRODUCT NAME& CODE:	PRICE
2 PCS CHALK LINE SET CODE: IHCLR0130	

PRODUCT NAME& CODE:	PRICE
5.0MM SCREW PLUG SET C/W SCREWHOOK CODE: IHWSPK5012	







PRODUCT NAME& CODE:

PRICE

**DIGITAL MULTIMETER 6000 COUNTS
TRUE RMS
CODE: IDM750 / IDM7502**



PRODUCT NAME& CODE:

PRICE

**LASER DISTANCE DETECTOR
CODE: IHLDD0401**



PRODUCT NAME& CODE:

PRICE

**3.0MM X 140MM PHASE TESTER
AC100-500V
CODE: IHSDT1908**

Ø4x190mm



NEW 01/2022

PRODUCT NAME& CODE:

PRICE

**CREE FLASH LIGHT WATERPROOF
GRADEIPX-4 LM 70
CODE: IHFL012AA1**

PRODUCT NAME& CODE:

PRICE

**CREE FLASH LIGHT WATERPROOF
GRADEIPX-4 LM 250
CODE: IHFL013D1**



PRODUCT NAME& CODE:

PRICE

**220-240V POWER WASHER
CODE: IHPWR20008**



PRODUCT NAME& CODE:

PRICE

**FLASHLIGHT LED 135 LM
CODE: IHFL013AAA1**



PRODUCT NAME& CODE:

PRICE

**50 MM PAINT BRUSH 100%
PURE BRISTLE
CODE: ICHPTB0502**



PRODUCT NAME& CODE:

PRICE

**75 MM PAINT BRUSH 100%
PURE BRISTLE
CODE: ICHPTB0503**



PRODUCT NAME& CODE:

PRICE

**100 MM PAINT BRUSH 100%
PURE BRISTLE
CODE: ICHPTB0504**



PRODUCT NAME& CODE:

PRICE

**CYLINDER BRUSH 8 IN 1 SET
INNER WALL AND OUTER WALL
CODE: IHKTCB83230083**



Acrylic

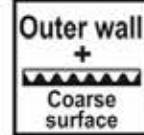

PRODUCT NAME& CODE:

PRICE

**25 MM PAINT BRUSH 100%
PURE BRISTLE
CODE: ICHPTB0501**



PRODUCT NAME& CODE:

PRICE

**13 IN 1 CYLINDER BRUSH SET
CODE: IHKTCB83230132**



INGCO unique design paint tray

PRODUCT NAME& CODE:

230MM ROLLER CYLINDER BRUSH
CODE:IHRHT342302

PRICE



	<input type="checkbox"/> Smooth Surface <input checked="" type="checkbox"/> Micro fibre <input type="checkbox"/> Middle Coarse Surface <input type="checkbox"/> Coarse Surface
	<input checked="" type="checkbox"/> Saving paint <input checked="" type="checkbox"/> Better performance <input checked="" type="checkbox"/> Don't have fibre shed

PRODUCT NAME& CODE:

100MM MINI ROLLER CYLINDER BRUSH
CODE:IHRHT071001

PRICE

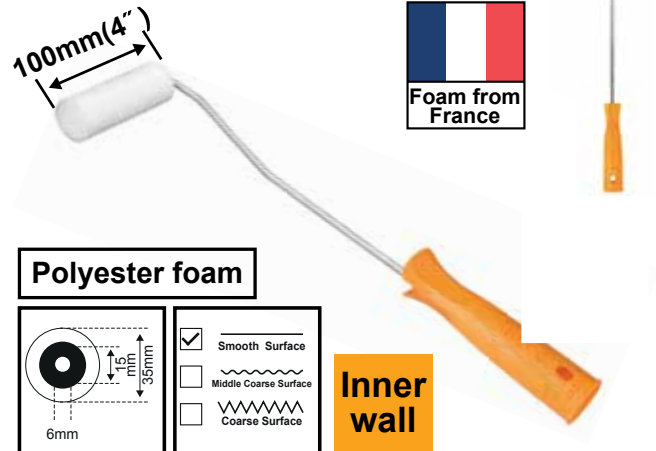

Polyester foam	<input checked="" type="checkbox"/> Smooth Surface <input type="checkbox"/> Middle Coarse Surface <input type="checkbox"/> Coarse Surface
	Inner wall

PRODUCT NAME& CODE:

230MM ROLLER COVER
CODE:IHRC0523007

PRICE

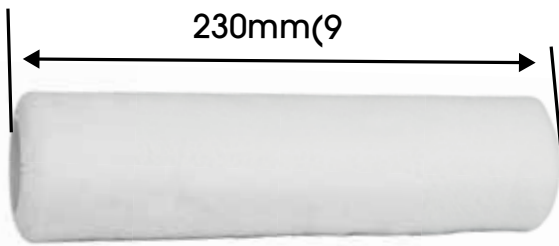

Acrylic	<input checked="" type="checkbox"/> Smooth Surface <input type="checkbox"/> Middle Coarse Surface <input type="checkbox"/> Coarse Surface
	Inner wall



PRODUCT NAME& CODE:

TELESCOPING CYLINDER BRUSH
CODE: IHRHT442302T

PRICE

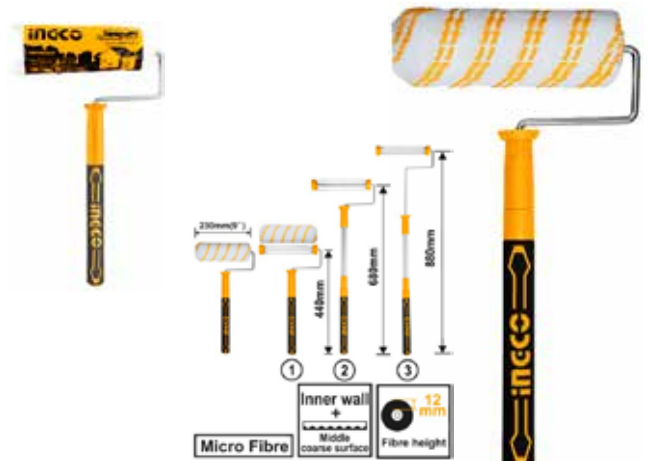

<input checked="" type="checkbox"/> Smooth Surface <input type="checkbox"/> Middle Coarse Surface <input type="checkbox"/> Coarse Surface	<input checked="" type="checkbox"/> Inner wall + Middle coarse surface <input type="checkbox"/> 12 mm Fibre height
Micro Fibre	

PRODUCT NAME& CODE:

100MM ROLLER COVER 10PK
CODE: IHRC5610012

PRICE

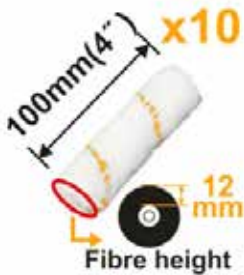

Micro fibre	Inner wall + Middle coarse surface
--------------------	---



PRODUCT NAME& CODE:

230MM MICRO FIBRE CYLINDER BRUSH
CODE: IHRHT042301

PRICE



NEW 03/2022

PRODUCT NAME& CODE:

PRICE

METAL TRIGGER NOZZLE
CODE: IHZATN1101



PRODUCT NAME& CODE:

PRICE

PLASTIC TRIGGER NOZZLE
CODE: IHWSG032



PRODUCT NAME& CODE:

PRICE

PLASTIC TRIGGER NOZZLE
CODE: IHWSG092



PRODUCT NAME& CODE:

PRICE

3PC HOSE QUICK CONNECTORS SET
CODE: IHHCS03122



PRODUCT NAME& CODE:

PRICE

5PC HOSE CONNECTORS
CODE: IHHCS05122



PRODUCT NAME& CODE:

PRICE

PRUNING SHEAR
CODE: IHPS0109



MAXφ12mm

NEW 01/2022

NEW 01/2022

PRODUCT NAME& CODE:

PRICE

PRUNING SHEAR BIG PROFESSIONAL
CODE: IHPS0308

NEW 01/2022



PRODUCT NAME& CODE:

PRICE

HEDGE SHEARS
CODE: IHHS6001

PRODUCT NAME& CODE:

PRICE

RUNING SHEAR PROFESSIONAL
CODE: IHPS0601



NEW 03/2022



NEW 01/2022

PRODUCT NAME& CODE:

PRICE

HIGH PRESSURE HOSE
CODE: IAHPH5028

PRODUCT NAME& CODE:

PRICE

PLASTIC 3 ARM ROTATORY SPRINKLER
CODE: IHPS23602



NEW 09/2022



NEW 03/2022



INGCO

SAFELINE



ABRASIVES & INDUSTRIAL

ABC HOUSE UNIT B, NEWTOWN
IND ESTATE COOLOCK DUBLIN

Call: 018486088
sales@abcabrasives.ie

www.abcabrasives.ie

ABRASIVES





PRE PACKED GLASS PAPER 5 SHEETS PER PACK

CODE	DESCRIPTION	PRICE	BOX QTY
PPA001	FINE		10PKS
PPA002	MEDIUM		10PKS
PPA003	COARSE		10PKS
PPA004	ASSORTED		10PKS



PRE PACKED WET & DRY SANDING PAPER 5 SHEETS PER PACK

CODE	DESCRIPTION	PRICE/PK	BOX QTY
PPA005	FINE		10PKS
PPA006	MEDIUM		10PKS
PPA007	COARSE		10PKS
PPA008	ASSORTED		10PKS



WET & DRY PAPER SHEETS

CODE	DESCRIPTION		PRICE/ SHEET	PK QTY
AP030	Waterproof Paper Sheets	60		50 Sheets
AP031	Waterproof Paper Sheets	80		50 Sheets
AP034	Waterproof Paper Sheets	150		50 Sheets
AP035	Waterproof Paper Sheets	180		50 Sheets
AP037	Waterproof Paper Sheets	240		50 Sheets
AP038	Waterproof Paper Sheets	280		50 Sheets
AP039	Waterproof Paper Sheets	320		50 Sheets
AP040	Waterproof Paper Sheets	360		50 Sheets
AP041	Waterproof Paper Sheets	400		50 Sheets
AP042	Waterproof Paper Sheets	500		50 Sheets
AP043	Waterproof Paper Sheets	600		50 Sheets
AP044	Waterproof Paper Sheets	800		50 Sheets
AP045	Waterproof Paper Sheets	1000		50 Sheets
AP046	Waterproof Paper Sheets	1200		50 Sheets



GLASS PAPER SHEETS (PRICE PER SHEET)

CODE	DESCRIPTION	GRADE	PRICE	PK QTY
AP021	Glass Paper Sheets	00		50 Sheets
AP022	Glass Paper Sheets	0		50 Sheets
AP023	Glass Paper Sheets	1		50 Sheets
AP024	Glass Paper Sheets	1 1/2		50 Sheets
AP026	Glass Paper Sheets	M2		50 Sheets
AP028	Glass Paper Sheets	2 1/2		50 Sheets
AP029	Glass Paper Sheets	3		50 Sheets



BLUE EMERY CLOTH SHEETS

CODE	DESCRIPTION	GRADE	PRICE/SHEET	PK QTY
AP055	Blue Emery Cloth Sheets 11"x 9"	180		50 Sheets

MOUSE QUATTRO SANDING 5 SHEETS PER PACK

CODE	DESCRIPTION	PRICE/PK	BOX QTY
PPA064	FINE		10PKS
PPA063	MEDIUM		10PKS
PPA062	COARSE		10PKS
PPA065	ASSORTED		10PKS



94 X 94 DELTA SHEET C/W HOLES 5 SHEETS PER PACK

CODE	DESCRIPTION	PRICE/PK	BOX QTY
PPA010	94 x 94 FINE		10PKS
PPA011	94 x 94 MEDIUM		10PKS
PPA012	94 x 94 COARSE		10PKS
PPA013	94 x 94 ASSORTED		10PKS

105 x 105 DELTA SHEETS C/W HOLE 5 SHEETS PER PACK

CODE	DESCRIPTION	PRICE/PK	BOX QTY
PPA014	105 x 105 FINE		10PKS
PPA015	105 x 105 MEDIUM		10PKS
PPA016	105 x 105 COARSE		10PKS
PPA017	105 x 105 ASSORTED		10PKS





**VELCRO ORBITAL SHEET 115X230 C/W HOLES
5 SHEETS PER PACK**

CODE	DESCRIPTION	PRICE/PK	BOX QTY
PPA020	FINE		10PKS
PPA021	MEDIUM		10PKS
PPA022	COARSE		10PKS
PPA023	ASSORTED		10PKS

100MM X 610MM (Pk of 3 Belts)

CODE	SIZE	GRIT	PER PK	BOX QTY
PPA070	100 X 610	COARSE		5PK
PPA071	100 X 610	MED		5PK
PPA072	100 X 610	FINE		5PK
PPA073	100 X 610	ASST		5PK

100MM X 620MM (Pk of 3 Belts)

CODE	SIZE	GRIT	PER PK	BOX QTY
PPA074	100 X 620	COARSE		5PK
PPA075	100 X 620	MED		5PK
PPA076	100 X 620	FINE		5PK
PPA077	100 X 620	ASST		5PK



75MM X 533MM (Pk of 3 Belts)

CODE	SIZE	GRIT	PER PK	BOX QTY
PPA078	75 X 533	COARSE		5PK
PPA079	75 X 533	MED		5PK
PPA080	75 X 533	FINE		5PK
PPA081	75 X 533	ASST		5PK



75MM X 457MM (Pk of 3 Belts)

CODE	SIZE	GRIT	PER PK	BOX QTY
PPA082	75 X 457	COARSE		5PK
PPA083	75 X 457	MED		5PK
PPA084	75 X 457	FINE		5PK
PPA085	75 X 457	ASST		5PK

FLOOR SANDING SHEETS

FLOOR SANDING SHEETS FOR DU8 and CLARKE MACHINE

CODE	DESCRIPTION	GRADE	PRICE PER SHEET	BOX QTY
AP101	Floor Sanding Sheets	24		20
AP102	Floor Sanding Sheets	36		20
AP103	Floor Sanding Sheets	40		20
AP104	Floor Sanding Sheets	50		20
AP105	Floor Sanding Sheets	60		20
AP106	Floor Sanding Sheets	80		20
AP107	Floor Sanding Sheets	100		20
AP108	Floor Sanding Sheets	120		20



SELF ADHESIVE FLOOR SANDING SHEETS FOR SQUARE BUFF MACHINE

CODE	DESCRIPTION	GRADE	PRICE PER SHEET	BOX QTY
AP140	460mm x 310mm	16		20 sheets
AP141	460mm x 310mm	24		20 sheets
AP142	460mm x 310mm	36		20 sheets
AP143	460mm x 310mm	50		20 sheets
AP144	460mm x 310mm	60		20 sheets
AP145	460mm x 310mm	80		20 sheets
AP146	460mm x 310mm	100		20 sheets
AP147	460mm x 310mm	120		20 sheets
AP148	460mm x 310mm Scotch Brite Pad Backing Pad	-----		25sheets



VELCRO ORBITAL SHEETS 115X230 C/W 2X5 HOLES

CODE	SIZE	GRIT	PER 1	BOX QTY
AP180	115X230	40		50
AP181	115X230	60		50
AP182	115X230	80		50
AP183	115X230	100		50
AP184	115X230	120		50

**LARGE ORBITAL SHEETS SIZE 115 X 280MM**

CODE	DESCRIPTION	GRADE	PRICE PER SHEET	BOX QTY
AP063	115 x 280	40		50 SHEETS
AP064	115 x 280	60		50 SHEETS
AP065	115 x 280	80		50 SHEETS
AP066	115 x 280	100		50 SHEETS
AP067	115 x 280	120		50 SHEETS

VELCRO DELTA SHEETS 100 X 147 C/W HOLES PACK 100

CODE	SIZE	GRIT	PER 1	BOX QTY
AP185	100 X 147	40		50 SHEETS
AP186	100 X 147	60		50 SHEETS
AP188	100 X 147	100		50 SHEETS
AP189	100 X 147	120		50 SHEETS

VELCRO DELTA SHEETS 3 X 2 DUST HOLES

CODE	SIZE	GRIT	PER 1	BOX QTY
AP195	94x94	150		50 SHEETS
AP197	94x94	180		50 SHEETS
AP196	94x94	320		50 SHEETS



SAFELINE





**VELCRO DISCS 150MM C/W HOLES
5 DISCS PER PACK**

CODE	DESCRIPTION	PRICE/ PK	QTY
PPA028	FINE		10PKS
PPA029	MEDIUM		10PKS
PPA030	COARSE		10PKS
PPA031	ASSORTED		10PKS

**VELCRO DISCS 125MM C/W HOLES
5 DISCS PER PACK**

CODE	DESCRIPTION	PRICE/ PK	QTY
PPA024	FINE		10PKS
PPA025	MEDIUM		10PKS
PPA026	COARSE		10PKS
PPA027	ASSORTED		10PKS



ZIRCONIA FLAP DISCS

CODE	SIZE	GRADE	PER 1	BOX QTY
PPA092	115MM X 22.2	40		10
PPA093	115MM X 22.2	60		10
PPA094	115MM X 22.2	80		10
PPA095	115MM X 22.2	100		10
PPA096	115MM X 22.2	120		10



FIBRE DISCS

100mm ALUMINIUM OXIDE FIBRE DISCS

CODE	SIZE	GRIT	PRICE	BOX
AD010	100mm x 16mm Fibre Disc	16		25
AD014	100mm x 16mm Fibre Disc	60		25
AD017	100mm x 16mm Fibre Disc	120		25

115mm ALUMINIUM OXIDE FIBRE DISCS

CODE	SIZE	GRIT	PRICE	BOX
AD018	115mm x 22mm Fibre Disc	16		25
AD019	115mm x 22mm Fibre Disc	24		25
AD020	115mm x 22mm Fibre Disc	36		25
AD021	115mm x 22mm Fibre Disc	50		25
AD022	115mm x 22mm Fibre Disc	60		25
AD023	115mm x 22mm Fibre Disc	80		25
AD024	115mm x 22mm Fibre Disc	100		25
AD025	115mm x 22mm Fibre Disc	120		25



FIBRE DISCS

150MM ALUMINIUM OXIDE FIBRE DISCS

CODE	SIZE	GRIT	PRICE	BOX
AD032	150mm X 22mm Fibre Disc	36		25
AD033	150mm X 22mm Fibre Disc	50		25
AD034	150mm X 22mm Fibre Disc	60		25
AD035	150mm X 22mm Fibre Disc	80		25

180mm ALUMINIUM OXIDE FIBRE DISCS

CODE	SIZE	GRIT	PRICE	BOX
AD040	180mm x 22mm Fibre Disc	16		25
AD041	180mm x 22mm Fibre Disc	24		25
AD042	180mm x 22mm Fibre Disc	36		25
AD043	180mm x 22mm Fibre Disc	50		25
AD044	180mm x 22mm Fibre Disc	60		25
AD045	180mm x 22mm Fibre Disc	80		25
AD046	180mm x 22mm Fibre Disc	100		25
AD047	180mm x 22mm Fibre Disc	120		25

7" CLOTH DISCS

CODE	DESCRIPTION	GRADE	PRICE PER 1	BOX QTY
AD162	7" J Flex Cloth Discs	80		50 SHEETS
AD164	7" J Flex Cloth Discs	180		50 SHEETS
AD166	7" J Flex Cloth Discs	320		50 SHEETS
AD167	7" J Flex Cloth Discs	400		50 SHEETS



SILICONE CARBIDE FIBRE DISCS



SEMI FLEX DISCS

180MM SILICON CARBIDE DISCS

CODE	SIZE	GRIT	PRICE	BOX QTY
AD050	180mm x 22mm Silicon Carbide Discs	16		25
AD051	180mm x 22mm Silicon Carbide Discs	24		25
AD056	180mm x 22mm Silicon Carbide Discs	120		25
AD058	180mm x 22mm Silicon Carbide Discs	180		25

SEMI FLEXIBLE DISCS

CODE	SIZE	GRIT	PRICE	BOX QTY
AD085	115mm x 22mm Semi Flexible Disc	16		25
AD087	115mm x 230mm Semi Flexible Disc	16		25
AD088	230mm x 22mm Semi Flexible Disc	24		25

VELCRO DISCS



150mm VELCRO DISCS (Plain) No Holes

CODE	DESCRIPTION	GRIT	PER 1	BOX QTY
AD101	Velcro Discs	40		50
AD103	Velcro Discs	80		50
AD104	Velcro Discs	100		50
AD105	Velcro Discs	120		50
AD106	Velcro Discs	150		50
AD107	Velcro Discs	180		50
AD108	Velcro Discs	220		50
AD109	Velcro Discs	240		50
AD112	Velcro Discs	400		50

125mm VELCRO DISCS WITH 8 HOLES

CODE	DESCRIPTION	GRIT	PER 1	BOX QTY
AD130	Velcro Discs	40		50
AD131	Velcro Discs	60		50
AD132	Velcro Discs	80		50
AD133	Velcro Discs	100		50
AD134	Velcro Discs	120		50
AD135	Velcro Discs	180		50
AD136	Velcro Discs	220		50
AD137	Velcro Discs	220		50
AD138	Velcro Discs	320		50
AD139	Velcro Discs	240		50

125mm VELCRO DISCS WITH 8 HOLES

CODE	DESCRIPTION	GRIT	PER 1	BOX QTY
AD115	with Holes	40		50
AD116	with Holes	60		50
AD117	with Holes	80		50
AD118	with Holes	100		50
AD119	with Holes	120		50
AD120	with Holes	150		50
AD121	with Holes	180		50
AD122	with Holes	220		50
AD123	with Holes	240		50
AD124	with Holes	280		50
AD125	with Holes	320		50
AD126	with Holes	400		50

125mm VELCRO DISCS (Plain) No Holes

CODE	DESCRIPTION	GRIT	PER 1	BOX QTY
AD140	Velcro Discs	40		50
AD141	Velcro Discs	60		50
AD142	Velcro Discs	80		50
AD143	Velcro Discs	100		50
AD144	Velcro Discs	120		50
AD146	Velcro Discs	220		50



ZIRCONIA FLAP DISCS

Code	Dia	Grade	PER 1	BOX QTY
AD306	115mm X 22mm	Z 40		10
AD308	115mm X 22mm	Z 80		10
AD307	115mm X 22.2mm	Z 40		10
AD309	115mm X 22mm	Z 100		10
AD310	115mm X 22mm	Z 120		10
AD316	180mm X 22mm	Z 24		10
AD317	180mm X 22mm	Z 36		10
AD311	180mm X 22mm	Z 40		10
AD312	180mm X 22mm	Z 60		10
AD315	180mm X 22mm	Z 120		10

PREMIUM FLAP DISCS

Code	Dia	Grade	PER 1	BOX QTY
AD306P	115mm X 22mm	Z 40		10
AD307P	115mm X 22mm	Z 60		10
AD308P	115mm X 22mm	Z 80		10
AD309P	115mm X 22mm	Z 100		10
AD310P	115mm X 22mm	Z 120		10

SANDING SPONGE

ALL SPONGES ARE SOLD IN BOXES , WE DO NOT BREAK BOXES

PRE PACKED SANDING SPONGES 100MM X 70MM X 25MM

CODE	DESCRIPTION	BOX	PRICE PER (1)
PPA035	MED/FINE	48	
PPA036	MED/COARSE	48	



LOW DENSITY SPONGES 125 X 100MM X 13MM 2 SPONGES PER PK

CODE	DESCRIPTION	BOX	PRICE/ PK
PPA088	36/36 COARSE	27PK	
PPA089	60/60 MEDIUM	27PK	
PPA090	100/100 FINE	27PK	

PREMIUM LOW DENSITY SPONGES

CODE	DESCRIPTION	PACK	PRICE PER (1)
1752	36/36 COARSE	250	
1753	60/60 MEDIUM	250	
1754	100/100 FINE	250	



For use with rotary floor machines, available in various sizes, depending on the size of your machine Different colour pads are for different jobs: Colour Coding BLACK – STRIPPING. For long lasting, heavy duty stripping BROWN – STRIPPING. Cuts away all old wax/floor finish, dry stripping GREEN – SCRUBBING. Heavy duty wet scrubbing BLUE – CLEANING. Moderate scrubbing or heavy spray cleaning MAROON – CLEANING. Cleans damp, buffs dry for spray cleaning RED – BUFFING. Dry or spray to remove scuffmarks and restore shine TAN – POLISHING. Dry polishing synthetic or natural finishes to high lustre WHITE – POLISHING. Non-aggressive dry polishing to a high gloss

VILEDA FLOOR POLISHING PADS

PART NO	SIZE MM	SIZE "	DESCRIPTION	Pack Qty	Price per Pad
FPBK 15	375	15"	BLACK	5	
FPG 15	375	15"	GREEN	5	
FPT 15	375	15"	TAN	5	
FPB 15	375	15"	BLUE	5	
FPW 15	375	15"	WHITE	5	
FPR 15	375	15"	RED	5	

VILEDA FLOOR POLISHING PADS

PART NO	SIZE MM	SIZE "	DESCRIPTION	Pack Qty	Price per Pad
FPBK 17	425	17"	BLACK	5	
FPG 17	425	17"	GREEN	5	
FPT 17	425	17"	TAN	5	
FPB 17	425	17"	BLUE	5	
FPW 17	425	17"	WHITE	5	
FPR 17	375	17"	RED	5	

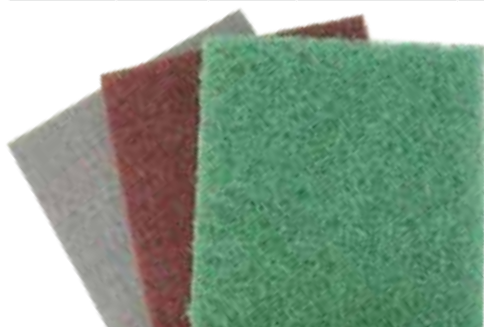

EXTREMELY FLEXIBLE, DOUBLE SIDED, NYLON ABRASIVE PAD. CAN BE USED ON WOOD, PAINT, METAL OR PLASTER, AND CAN BE USED WET OR DRY.

FIBRAL INDUSTRIAL SCOURING PADS

PART NO	SIZE MM	DESCRIPTION	Pack Qty	Price per Pad
VFA	230 X 150	Very Fine (A) Red	10	
UFS	230 X 150	Ultra Fine (S) Grey	10	
LDG	230 X 150	Light Duty Green	10	
HDG	230 X 150	Heavy Duty Green	10	



100mm X 610mm			
CODE	GRIT	PRICE PER (1)	PK QTY
SB001	40		5
SB002	60		5
SB003	80		5
SB004	100		5
SB005	120		5

110mm X 620mm			
CODE	GRIT	PRICE PER (1)	PK QTY
SB009	40		10
SB010	50		10
SB011	60		10
SB013	100		10
SB014	120		10

75mm X 533mm			
CODE	GRIT	PRICE PER (1)	PK QTY
SB018	40		10
SB020	60		10
SB021	80		10
SB022	100		10
SB023	120		10

100mm X 550mm			
CODE	GRIT	PRICE PER (1)	PK QTY
SB054	40		10
SB055	60		10
SB056	80		10
SB057	100		10
SB058	120		10

74mm X 457mm			
CODE	GRIT	PRICE PER (1)	PK QTY
SB026	40		10
SB027	60		10
SB028	80		10
SB029	100		10
SB030	120		10

100mm X 560m			
CODE	GRIT	PRICE PER (1)	PK QTY
SB062	40		10
SB063	60		10
SB064	80		10
SB065	100		10
SB066	120		10

**65mm X 410mm**

CODE	GRIT	PRICE PER (1)	PK QTY
SB078	40	€1.52	10
SB079	80	€1.52	10
SB080	120	€1.52	10

100mm X 915mm

CODE	GRIT	PRICE PER (1)	PK QTY
SB091	40	€4.78	10
SB092	60	€4.21	10
SB093	80	€4.21	10
SB094	100	€3.99	10
SB095	120	€3.99	10

75mm X 510mm

CODE	GRIT	PRICE PER (1)	PK QTY
SB040	40	€1.68	10
SB041	60	€1.68	10
SB043	100	€1.68	10
SB044	120	€1.68	10

75mm X 480mm

CODE	GRIT	PRICE PER (1)	PK QTY
SB032	40	€1.68	10
SB033	60	€1.68	10
SB034	80	€1.68	10
SB035	100	€1.68	10
SB036	120	€1.68	10

150mm X 1090mm

CODE	GRIT	PRICE PER (1)	PK QTY
SB098	40	€6.19	10
SB100	60	€6.11	10
SB101	80	€5.68	10
SB102	100	€5.85	10
SB103	120	€5.85	10

150mm X 1219mm

CODE	GRIT	PRICE PER (1)	PK QTY
SB106	40	€6.71	10
SB108	60	€6.37	10
SB109	80	€6.08	10
SB110	100	€6.08	10
SB111	120	€6.30	10

75mm X 610mm

CODE	GRIT	PRICE PER (1)	PK QTY
SB047	40	€1.68	10
SB048	60	€1.68	10
SB051	120	€1.68	10

60mm x 400mm

CODE	GRIT	PRICE PER (1)	PK QTY
SB070	40	€1.74	10
SB072	100	€1.74	10

**NEW TO
OUR
RANGE!**

MULTI PACK ABRASIVE ROLLS

5 rolls of sandpaper , each measuring 115mm x 50mtr. Available in grades 40 , 60 , 80 , 100 , 120. The pack holds 24 rolls and can be assorted grades , or whatever grades suits your needs. These rolls are an ideal combination of flexible , long lasting abrasive material that is durable , yet easy to tear off and is also very economical .

CODE	GRIT	PRICE
AR154	40	€1.33
AR155	60	€1.33
AR156	80	€1.33
AR157	100	€1.33
AR158	120	€1.33

**TOTAL
COST OF THE BOX
€31.03**





**ECONOMY GREEN ROLLS SANDPAPER
(115mm WIDE X 50 MTR LONG)**

CODE	DESCRIPTION	GRIT	PER ROLL	BOX-QTY
AR100	Green Sandpaper Rolls	40		1
AR101	Green Sandpaper Rolls	60		1
AR102	Green Sandpaper Rolls	80		1
AR103	Green Sandpaper Rolls	100		1
AR104	Green Sandpaper Rolls	120		1

**ECONOMY GREEN ROLLS SANDPAPER (SHORT)
(115mm WIDE X 10 MTR LONG)**

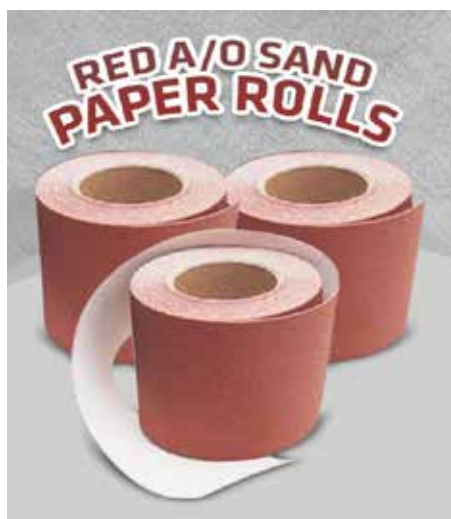
CODE	DESCRIPTION	GRIT	PER ROLL	BOX-QTY
AR110	Green Sandpaper Rolls	40		1
AR111	Green Sandpaper Rolls	60		1
AR112	Green Sandpaper Rolls	80		1
AR113	Green Sandpaper Rolls	100		1
AR114	Green Sandpaper Rolls	120		1

RED SAND PAPER ROLLS (115mm x 50 MTR LONG)

CODE	DESCRIPTION	GRIT	PRICE	BOX QTY
AR086	115mm x 50mtr Red Sandpaper Rolls	40		1
AR087	115mm x 50mtr Red Sandpaper Rolls	60		1
AR088	115mm x 50mtr Red Sandpaper Rolls	80		1
AR089	115mm x 50mtr Red Sandpaper Rolls	100		1
AR090	115mm x 50mtr Red Sandpaper Rolls	120		1
AR091	115mm x 50mtr Red Sandpaper Rolls	150		1
AR092	115mm x 50mtr Red Sandpaper Rolls	180		1
AR093	115mm x 50mtr Red Sandpaper Rolls	220		1
AR094	115mm x 50mtr Red Sandpaper Rolls	240		1
AR095	115mm x 50mtr Red Sandpaper Rolls	280		1
AR096	115mm x 50mtr Red Sandpaper Rolls	320		1
AR097	115mm x 50mtr Red Sandpaper Rolls	400		1

STERATE PAPER ROLLS (115MM X 50 METRES LONG)

CODE	DESCRIPTION	GRIT	PRICE	BOX QTY
AR130	Sterate Paper Rolls	80		1
AR131	Sterate Paper Rolls	120		1
AR132	Sterate Paper Rolls	150		1
AR133	Sterate Paper Rolls	180		1
AR134	Sterate Paper Rolls	240		1
AR135	Sterate Paper Rolls	320		1
AR136	Sterate Paper Rolls	400		1

EMERY CLOTH ROLLS 50MM X 50METERS LONG

CODE	DESCRIPTION	GRADE	PRICE	BOX QTY
AR030	Emery Rolls 50mm x 50mtr	40		1
AR031	Emery Rolls 50mm x 50mtr	60		1
AR032	Emery Rolls 50mm x 50mtr	80		1
AR033	Emery Rolls 50mm x 50mtr	100		1
AR034	Emery Rolls 50mm x 50mtr	120		1
AR035	Emery Rolls 50mm x 50mtr	150		1
AR036	Emery Rolls 50mm x 50mtr	180		1
AR037	Emery Rolls 50mm x 50mtr	220		1
AR039	Emery Rolls 50mm x 50mtr	320		1
AR040	Emery Rolls 50mm x 50mtr	400		1



CIRCULAR BRUSHES FOR BENCH GRINDER

CODE	DESCRIPTION	PER 1	QTY
WB11	6 X 1 X 1/2 Wire Brush		5
WB12	8 X 1 X 5/8 Wire Brush		5

180MM KNOTTED CIRCULAR BRUSH

CODE	DESCRIPTION	PER 1	QTY
WB15	180mm Knotted Brush (Suits 230mm Angle Grinder)		5

**CUP BRUSH FOR 230MM ANGLE GRINDERS**

CODE	DESCRIPTION	PER 1	QTY
WB19	100mm Knotted Wire Brush M14		5
WB20	125mm Crimped Wire Brush M14		5

CUP BRUSHES FOR 100MM & 115MM MINI GRINDER

CODE	DESCRIPTION	PER 1	QTY
WB24	75mm M10 x 1.25 Crimped Brush For 100mm MAKITA Angle Grinder		5
WB25	75mm M10 x 1.50 Crimped Brush For 100mm HITACHI Angle Grinder		5
WB26	75mm x M14 Crimped Brush For 115mm Angle Grinder		5
WB27	75mm M10 x 1.25 Knotted Brush For 100mm MAKITA Angle Grinder		5
WB28	75mm M10 x 1.5 Knotted Brush For 100mm HITACHI grinder		5
WB29	75mm x M14 Knotted Brush for 115mm Angle Grinder		5



SHAFT-MOUNTED CUP BRUSHES

CODE	DESCRIPTION	PER 1	QTY
WB38	50mm Cup Wire Brush On Spindle		10
WB39	75mm Cup Wire Brush On Spindle		10



SHAFT-MOUNTED FLAT CIRCULAR BRUSHES

CODE	DESCRIPTION	PER 1	QTY
WB42	50mm (flat) Wire Brush On Spindle		10
WB43	75mm (flat) Wire Brush On Spindle		10
WB44	100mm (flat) Wire Brush On Spindle		10



check price please



CODE	DESCRIPTION	PER 1	QTY
WB32	4 Row Hand Wire Brushes		24
WB33	5Row Hand Wire Brushes		24

BOX OF ASSORTED WIRE BRUSHES ON SPINDLES

CODE	DESCRIPTION	PER 1	QTY
WB50	24 Assorted Brushes on Spindles		24

SPID TYPE WIRE BRUSH WITH PLASTIC HANDLE

CODE	DESCRIPTION	PER 1	QTY
WB48	Plastic Handle Wire Brush		24



FLAP WHEELS

CODE	DIA X WIDTH	GRIT	PRICE PER 1
FW6030 40	60mm X 30mm	40	
FW6030 80	60mm X 30mm	80	
FW 6030 120	60mm X 30mm	120	
FW8030 40	80mm X 30mm	40	
FW8030 80	80mm X 30mm	80	
FW8030 120	80mm X 30mm	120	
FW6040 40	60mm X 40mm	40	
FW6040 80	60mm X 40mm	80	
FW6040 120	60mm X 40mm	120	
FW3010 40	30mm X 10mm	40	
FW5020 40	50mm X 20mm	40	
FW5020 120	50mm X 20mm	120	
FW6015 40	60mm X 15mm	40	
FW6015 120	60mm X 15mm	120	



RESIN CENTRE FLAP WHEELS

CODE	DIA X WIDTH	GRIT	PRICE PER 1
FW6140	150mm X 25mm	40	
FW61120	150mm X 25mm	120	
FW6280	150mm x 50mm	80	
FW62100	150mm x 50mm	100	
FW62120	150mm x 50mm	120	



100MM X 50MM X 50MM FLOOR GRINDING STONES

CODE	DESCRIPTION	PRICE (1)	BOX QTY
42216	FLOOR GRINDING STONES GRIT 16 (Extra Coarse)		6
42224	FLOOR GRINDING STONES GRIT 24 (Coarse)		6
42236	FLOOR GRINDING STONES GRIT 36 (Coarse)		6
42254	FLOOR GRINDING STONES GRIT 54 (Medium)		6
42280	FLOOR GRINDING STONES GRIT 80 (Fine)		6



CUTTING

DOMINATOR

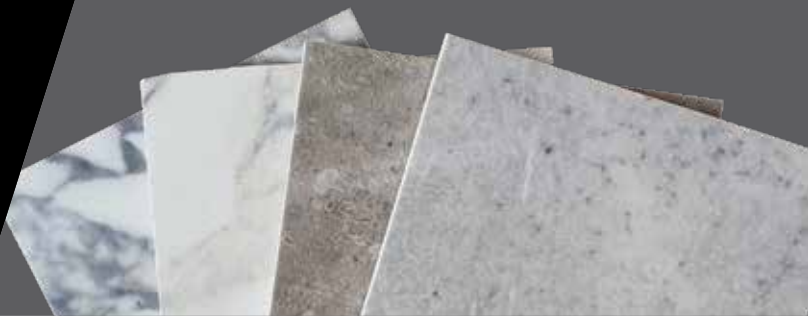

CUTTING

CUTTING



MPA HANNOVER CERTIFIED

TILE DIAMOND BLADES

CODE	DESCRIPTION	PRICE
DM23022T	DOMINATOR TILE BLADE 230MM X 22 BORE	
DM11522T	NEW DOMINATOR TILE DIAMOND BLADE 115 MM X 22 BORE	
DM20300	FLOOR GRINDER 20 TEETH 250 MM X 20 MM	

DOMINATOR

CONCRETE

METAL

WOOD

CUTTING

CUTTING

MPA HANNOVER CERTIFIED
SEGMENTED DIAMOND BLADES

CODE	DESCRIPTION	PRICE
DM11522	DOMINATOR DIAMOND BLADE 115MM X 22 MM BORE	
DM23022	DOMINATOR DIAMOND BLADE 230MM X 22 BORE	
DM30020	DOMINATOR DIAMOND BLADE 300MM X 20 MM	
DM30022	DOMINATOR DIAMOND BLADE 300MM X 22 BORE	
DM35020	DOMINATOR LANDSCAPING BLADE 350mm x 20mm Bore	
DM35025	DOMINATOR LANDSCAPING BLADE 350mm x 25mm Bore	

SAFELINE BLISTER PACKED DIAMOND BLADES

CUTTING



CUTTING

• **DRY CUTTING BLADES FOR USE ON** •
ANGLE GRINDERS • CONSAW'S • ROADSAW'S

SEGMENTED DIAMOND BLADES				
Part No	Diameter	Bore (mm)	Price per Blade	Pack Qty
D3101	100mm	15.88		1
D3102	115mm	22.23		1
D3103	125mm	22.23		1
D3104	150mm	22.23		1
D3105	230mm	22.23		1
D3106	300mm	22.23		1
D3107	300mm	20.00		1
D3112	350mm	25.40		1



Part No	Diameter	Bore (mm)	Price per Blade	Pack Qty
D3120	100mm	16.00		1
D3121	115mm	22.20		1
D3122	125mm	22.20		1
D3123	150mm	22.20		1
D3124	178mm	25.40		1



Part No	Diameter	Bore (mm)	Price per Blade	Pack Qty
D3115	115mm	22.20		1
D3116	230mm	22.20		1

S-DUO

RECOMMENDED FOR



ASPHALT & MACADAM



ALL CONCRETE



GRIT STONE

S DUO DIAMOND BLADE

Red Ten - A brand leading range of high quality and cost effective cutting tools which has stood the test of time over two decades earning a reputation for durability, safety and cost effective performance.

Trade Performance, S DUO Diamond Blade in Various Sizes

- A genuine dual purpose blade in the trade price bracket
- Fast Cutting lazer welded segment
- Ideal for Asphalt, Macadam, all Concrete and Grit Stone



RED TEN DIAMOND BLADES

CODE	DIA	SEG	BORE	PRICE
DB00580	300mm (12")	8mm	20mm	
BMI350/25	350mm (14")	12mm	25mm	
BMI40020	400mm (16")	12mm	20mm	
BMI40025	400mm (16")	12mm	25mm	
BMI45025	450mm (18")	12mm	25mm	

4PC DIAMOND BLADE SET 115MM**CODE: D3126****FEATURES**

- FOR CUTTING GRANITE , MARBLE , BRICK CERAMIC ETC
 - PACK INCLUDES : 2 X SEGMENTED BLADES , 1 X CONTINUOUS BLADE , 1 X TURBO SAW BLADE
 - ALL OF THESE BLADES ARE 115 X 7 X 2 X 22.2MM
- BAR CODE: 5391361234216

**5PC DIAMOND CUTTING BLADE SET IN CARRY CASE****CODE: D3127****FEATURES**

- FOR CUTTING CONCRETE , MASONRY , STONE , ASPHALT , REFRACTORIES , GRANITE , MARBLE
- PACK INCLUDES : 2 X 115MM SEGMENTED BLADES , 1 X 230MM SEGMENTED BLADE , 1 X 115MM CONTINUOUS BLADE , 1 X 115MM TURBO BLADE



- Conforms to industry safety standard EN12413
- Time-proven grinding performance
- Proven pedigree
- Designed for use with all the popular manufacturer's machines
- Glass-fibre reinforced resinoid bonded.
- Dimensions: 115mm , 230mm , 300 mm
- Bore: 20 mm – 22mm
- Thickness: 3.2

FLAT STONE CUTTING DISC

PART NO	DIAMETER	WIDTH (MM)	BORE (MM)	Type	Price per Disc	Pack Qty
AD250	300mm / 12"	3.2	22.20	Flat		10
AD251	300mm / 12"	3.2	20.00	Flat		10

DEPRESSED CENTRE STONE CUTTING DISC

PART NO	DIAMETER	WIDTH (MM)	BORE (MM)	Type	Price per Disc	Pack Qty
AD221	115mm / 1/2"	3.2	22.20	DPC		25
AD224	230mm / 9"	3.2	22.20	DPC		25



RASTA CUTTING

STONE CUTTING DISCS

CODE	DESCRIPTION	PRICE (1)	BOX QTY
RA221	115MM X 3.0 X 22.2 D/C STONE CUTTING DISCS		25
RA224	230MM X 3.0 X 22.2 D/C STONE CUTTING DISCS		25

STONE CUTTING DISCS FLAT

CODE	DESCRIPTION	PRICE (1)	BOX QTY
RA250	300MM X 3.0 X 22.2 FLAT STONE CUTTING DISCS		10
RA251	300MM X 3.0 X 20.0 FLAT STONE CUTTING DISCS		10



CUTTING

CUTTING

RASTA CUTTING & GRINDING DISCS

METAL GRINDING DISCS DEPRESSED CENTRE

CODE	DESCRIPTION	PRICE (1)	BOX QTY
RA200	RASTA DISC PYRAMID STAND		
RA201	100MM X 6 X 22.2 D/C METAL GRINDING DISCS		10
RA202	115MM X 6 X 22.2 D/C METAL GRINDING DISCS		10
RA205	230MM X 6 X 22.2 D/C METAL GRINDING DISCS		10

METAL CUTTING DISCS DEPRESSED CENTRE

RA210	100MM X 3.0 X 16.0 D/C METAL CUTTING DISCS		25
RA211	115MM X 3.0 X 22.2 D/C METAL CUTTING DISCS		25
RA212	125MM X 3.0 X 22.2 D/C METAL CUTTING DISCS		25
RA214	230MM X 3.0 X 22.2 D/C METAL CUTTING DISCS		25

STONE CUTTING DISCS DEPRESSED CENTRE

RA221	115MM X 3.0 X 22.2 D/C STONE CUTTING DISCS		25
RA224	230MM X 3.0 X 22.2 D/C STONE CUTTING DISCS		25

METAL CUTTING DISCS FLAT

RA235	300MM X 3.0 X 22.2 FLAT METAL CUTTING DISCS		10
RA236	300MM X 3.0 X 20.0 FLAT METAL CUTTING DISCS		10
RA238	300MM X 2.8 X 25.4 METAL CUTTING CHOP SAW DISCS		10
RA239	350MM X 3.0 X 25.4 FLAT METAL CHOP SAW DISCS		10

RAIL CUT DISCS

RA240	350MM X 4.0 X 25.4 rail cut disc max5400rpm		25
RA241	300MM X 3.5 X 20 rail cut disc		25

STEEL CUTTING MAX5500RPM

RA242	350MM X 4.0 X 20MM STEEL CUTTING max5500rpm		25
-------	---	--	----

SUPER THIN METAL & STAINLESS STEEL DISCS

RA292	230MM X 1.9 STAINLESS STEEL CUTTING DISCS		25
RA293	115MM X 1.0 STAINLESS STEEL CUTTING DISCS		25

SAFELINE

CUTTING DISC

NEW IMPROVED DISC



**115 MM X 1MM
FAST CUT DISC**



**NOW AVAILABLE IN
10 PACK DISPLAY**

SAFELINE CUTTING DISC

CUTTING



CUTTING

STAINLESS STEEL CUTTING DISC

PART NO	DIAMETER	WIDTH (MM)	BORE (MM)	Type	Price per Disc	Pack Qty
AD292	230mm / 9"	1.9	22.2	Flat		10
AD293	115mm / 4 1/2"	1.0	22.2	Flat		10

METAL GRINDING DISC

PART NO	DIAMETER	WIDTH (MM)	BORE (MM)	Type	Price per Disc	Pack Qty
AD202	115/ 4 1/2"	6.5	22.2	DPC		25

DEPRESSED CENTRE METAL CUTTING DISC

PART NO	DIAMETER	WIDTH (MM)	BORE (MM)	Type	Price per Disc	Pack Qty
AD211	115/ 4 1/2"	3	22.2	DPC		25
AD214	230mm / 9"	3	22.2	DPC		25

FLAT STEEL DISC

PART NO	DIAMETER	WIDTH (MM)	BORE (MM)	Type	Price per Disc	Pack Qty
AD235	300mm / 12"	3	22.23	Flat		25
AD236	300mm / 12"	3	20.00	Flat		25

TUNGSTEN CARBIDE TIPPED SAW BLADES FOR WOOD



CUTTING

CUTTING

CODE	DESCRIPTION	PRICE
TC620	150mm T.C.T. SAW Blades 20 Teeth	
TC624	150mm T.C.T. SAW Blades 24 Teeth	
TC630	150mm T.C.T. SAW Blades 30 Teeth	
TC640	150mm T.C.T. SAW Blades 40 Teeth	
TC648	150mm T.C.T. SAW Blades 48 Teeth	
TC660	150mm T.C.T. SAW Blades 60 Teeth	
TC6520	165mm TCT SAW Blades 20 Teeth	
TC6524	165mm TCT SAW Blades 24 Teeth	
TC6530	165mm TCT SAW Blades 30 Teeth	
TC6540	165mm TCT SAW Blades 40 Teeth	
TC6548	165mm TCT SAW Blades 48 Teeth	
TC6560	165mm TCT SAW Blades 60 Teeth	
TC720	180mm T.C.T. SAW Blades 20 Teeth	
TC724	180mm T.C.T. SAW Blades 24 Teeth	
TC730	180mm T.C.T. SAW Blades 30 Teeth	
TC740	180mm T.C.T. SAW Blades 40 Teeth	
TC760	180mm T.C.T. SAW Blades 60 Teeth	
TC820	200mm T.C.T. SAW Blades 20 Teeth	
TC830	200mm T.C.T. SAW Blades 30 Teeth	
TC840	200mm T.C.T. SAW Blades 40 Teeth	
TC860	200mm T.C.T. SAW Blades 60 Teeth	

TUNGSTEN CARBIDE TIPPED SAW BLADES FOR WOOD

CODE	DESCRIPTION	PRICE
TC21620	216mm TCT Blade 20 Teeth	
TC21630	216mm TCT Blade 30 Teeth	
TC21640	216mm TCT Blade 40 Teeth	
TC21660	216mm TCT Blade 60 Teeth	



CUTTING

CODE	DESCRIPTION	PRICE
TC920	230mm T.C.T. Blades 20 Teeth	
TC930	230mm T.C.T. Blades 30 Teeth	
TC940	230mm T.C.T. Blades 40 Teeth	
TC960	230mm T.C.T. Blades 60 Teeth	

CODE	DESCRIPTION	PRICE
TC1040	250mm T.C.T Blade 40 Teeth	
TC1060	250mm T.C.T Blade 60 Teeth	
TC1080	250mm T.C.T Blade 80 Teeth	
TC1096	250mm T.C.T Blade 96 Teeth	



CODE	DESCRIPTION	PRICE
TC1240	300mm T.C.T. Blades 40 Teeth	
TC1260	300mm T.C.T. Blades 60 Teeth	
TC1296	300mm T.C.T. Blades 96 Teeth	

CUTTING

NEW!

MULTI TOOL CUTTING SET

JSEK200

- BLADE 1 - HCS 33M WOOD & PLASTIC
- BLADE 2- BI METAL 33MM METAL & WOOD
- BLADE 3 - HCS 65MM WOOD & PLASTIC

CUTTING

CUTTING

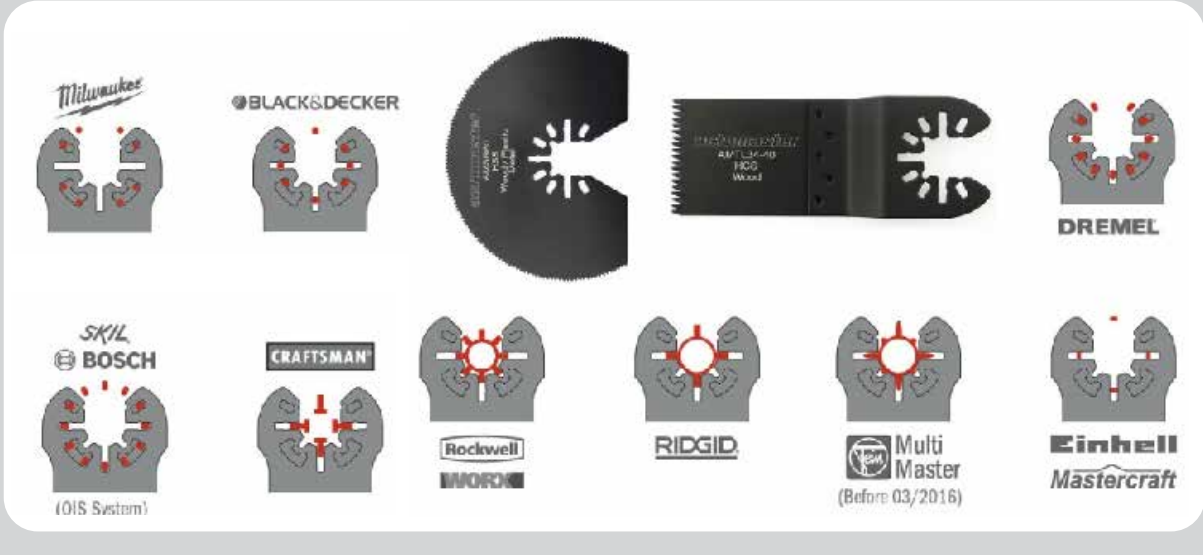
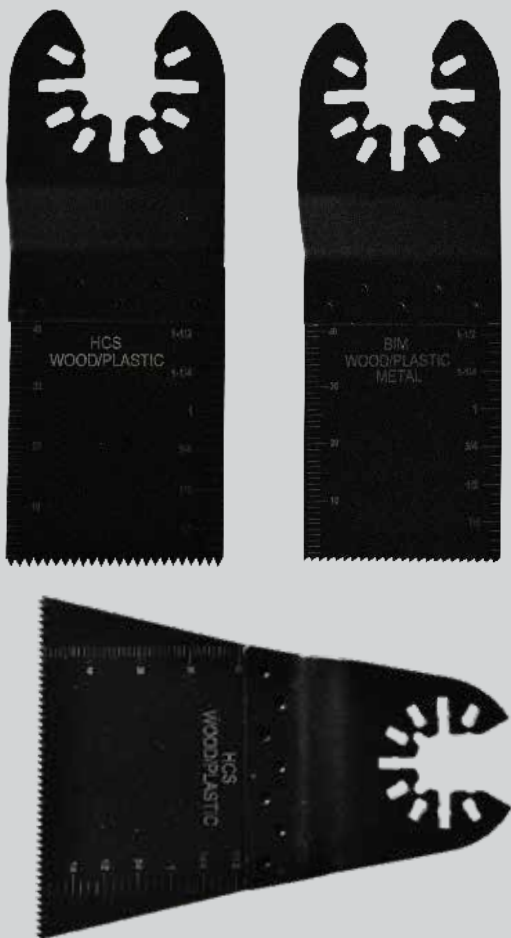



CUTTING

CUTTING

SAFELINE JIG SAW BLADES (PACKS OF 5)

CODE	DESCRIPTION	PER PK	BX QTY
JST144D	BOSCH T144D JIG SAW BLADES FAST COARSE WOOD		10 PK
JST118A	BOSCH T118A JIG SAW BLADES SHEET METAL		10 PK
JST111C	BOSCH T111C JIG SAW BLADES FAST COARSE WOOD		10 PK
JST101B	BOSCH T101B JIG SAW BLADES CLEAN WOOD CUTTING		10 PK
JST101D	BOSCH T101D (5502) JIG SAW BLADES FOR WOOD		10 PK
JST127D	BOSCH T127D JIG SAW BLADES ALUMINIUM CUTTING		10 PK
JST119B	BOSCH T119B JIG SAW BLADES CHIPBOARD CUTTING		10 PK
JST119A	BOSCH T119A JIG SAW BLADES FOR WOOD		10 PK
JSTEK5	ASSORTED JIG SAW SET METAL/WOOD T144D T101B T101AO T118A T118B		10 PK

SAFELINE SABRE SAW BLADES (PACKS OF 5)

CODE	DESCRIPTION	PER PK	BX QTY
JSEK114	12" (300MM) SABRESAW BLADES WOOD (PK5) CC		10 PK
JSEK102	6" (150MM) SABRESAW BLADES METAL (PK5)		10 PK
JSEK115	9" (225MM) SABRESAW BLADES METAL 9TPI (PK5)		10 PK
JSK117	6" SABRE SAW BLADE WOOD/PLASTERBOARD 6TPI		10 PK
JSEK104	6" SABRESAW BLADES PLAST/WOOD 10TPI (PK5)		10 PK
JSEK106	9" (230MM) SABRESAW BLADES WOOD 10TPI (PK5)		10 PK
JSEK116	12" (300MM) SABRESAW BLADES MILD STEEL (PK5)		10 PK



CUTTING

CUTTING

HACKSAW BLADES

CODE	DESCRIPTION	PER 1	BOX QTY
HB1218	12 x 18 TPI Blades		100 PK
HB1224	12 x 24 TPI Blades		100 PK
HB1232	12 x 32 TPI Blades		100 PK

SABRE SAW BLADES TO SUIT AEG - BOSCH - METABO (PACK OF 5 BLADES)

CODE	DESCRIPTION	PER PK	BX QTY
G115352	150MM BI-METAL BLADE FLEXIBLE BLADES FOR METAL 18TPI 111020/111022		10 PK
G115355	150MM BLADE FOR COARSE CUTTING WOOD, PLASTER AND PLASTERBOARD. 6TPI 112040		10 PK
G115208	150MM LONG BLADE ROUGH & FAST CUT WOOD		10 PK
G115356	250MM BLADE FOR COA WOOD CUTTING 6TPI 112271		10 PK
G115357	225MM BLADE FOR THIN METAL CUTTING 18TPI 111035		10 PK
G115219	250MM LONG BLADE ROUGH & FAST CUT WOOD 112051		10 PK
G115370	250MM BI METAL BLADE FOR METAL AND NAILED WOOD 111034		10 PK
G115216	300MM LONG BLADE CUT WOOD 112145		10 PK
G115358	300MM LONG BLADE FOR METAL & PLASTIC. 6TPI 111032		10 PK
G115359	300MM BLADE FOR MILD STEEL, PIPES, PROFILES, STAINLESS STEEL UP TO 3MM, CAST IRON & NON FERROUS METAL 10TPI 111031 / 111022		10 PK
G111022	6" (150MM) SABRESAW BLADES UNIVERSAL (PK5)		10 PK
G115207	6" (150MM) SABRESAW BLADES WOOD TO 4MM (PK5) 112142 / 1120402		10 PK
G115215	12" (300MM) SABRESAW BLADES WOOD (PK5) CC 11204		10 PK
G115346	6" SABRESAW BLADES PLAST/WOOD 6TPI (PK5) 112041		10 PK
G115367	SABRE SAW BLADES 300MM MILD STEEL PIPES & S/S 111206		10 PK
G115374	10" SABRESAW BLADES METAL 14TP1 (PK5)WOOD 111205		10 PK
G115376	12" (300MM) SABRESAW BLADES STEEL (PK5) 111031		10 PK
G115379	12" (300MM) SABRESAW BLADES STEEL/WOOD (PK5)111032		10 PK



DOMINATOR



€65.00
per 100

CUTTING

CUTTING



**ALSO
SOLD IN
10'S**

**THE PROFESSIONAL
CHOICE**

**SUPERIOR QUALITY
BI - METAL HACKSAW BLADE**

DOMINATOR HACK SAW BLADES

CODE	DESCRIPTION	PER 1	BOX QTY
DHB18	12 x 18 TPI Blades 10pk of 5		50 PK
DHB24	12 x 24 TPI Blades 10pk of 10		100 PK
DHB32	12 x 32 TPI Blades 10pk of 5		50 PK

Qty Break: you can mix and match any of the above sizes to avail of the lower prices.



NEW 3 TIER PLANOGRAM LAYOUTS

1200mm wide stand with 9 removable module.

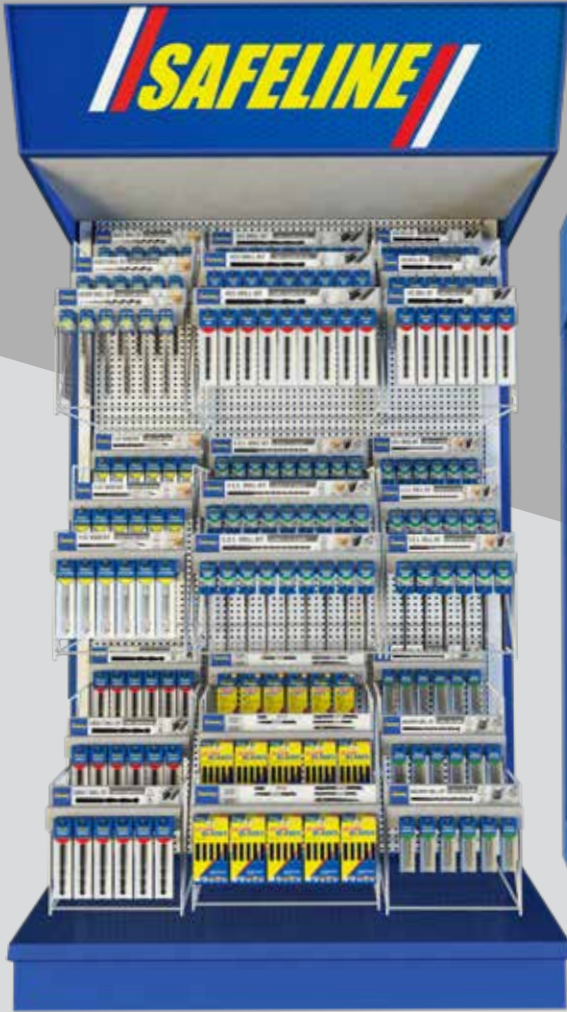

DRILLING

375/425MM MODULE

MAXIMISE PROFITS ON YOUR POWER ACCESSORY STANDS

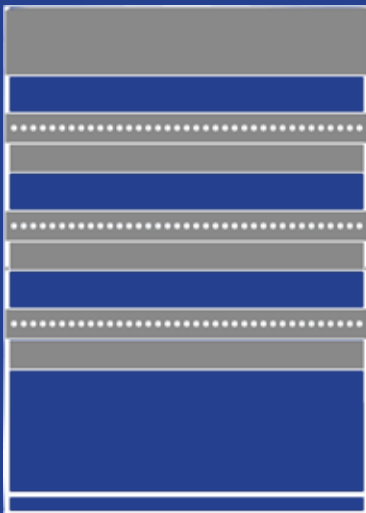

FRONT

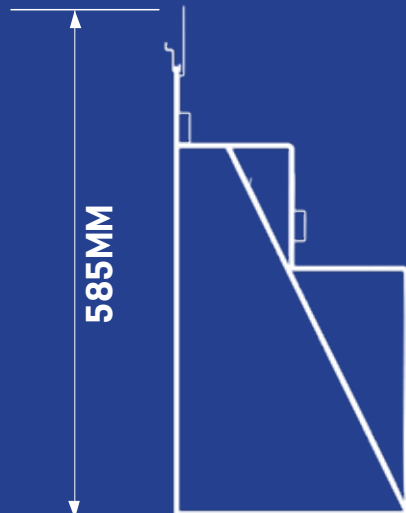

SIDE

585MM



PERSPECTIVE VIEW

AUGER DRILL BIT

SAFELINE



STAND DETAILS

- 1.20 metre wide stand with 9 removable module.
- 6 pieces 375mm Modules
- 3 pieces 425mm Modules

BANNER LABELS

This helps customers to easily identify what kind of material it cuts and what power tool fixture it

49mm X 375mm Modules



49mm X 425mm Modules



AREA 1

AUGER DRILL BITS

STANDARD		
CODE	DIMENSIONS (MM)	PER
AB 60	6.0 X 235	
AB 70	7.0 X 235	
AB 80	8.0 X 235	
AB100	10.0 X 235	
AB120	12.0 X 235	
AB130	13.0 X 235	
AB140	14.0 X 235	
AB150	15.0 X 235	
AB160	16.0 X 235	
AB180	18.0 X 235	
AB190	19.0 X 235	
AB200	20.0 X 235	
AB220	22.0 X 235	
AB240	24.0 X 235	
AB250	25.0 X 235	



SDS PLUS



HEX SHANK



CARBON TIP

WOOD



SIZE

FRONT

MATERIAL QUALITY
FITTING IDENTIFIER



BACK

MATERIAL
CODE
BARCODE

375MM MODULE SELECTION (STANDARD)



Stock Profile-Single Module			
	TYPE/SIZE (MM)	PRODUCT CODE	Qty
1	20.0 X 235MM	AB200	5
2	18.0 X 235MM	AB180	5
3	10.0 X 235MM	AB100	5
4	12.0 X 235MM	AB120	5
5	16.0 X 235MM	AB160	5
6	25.0 X 235MM	AB250	5
<hr/>			
1	12.0 X 400MM	ABL120	5
2	16.0 X 400MM	ABL160	5
3	18.0 X 400MM	ABL180	5
4	20.0 X 400MM	ABL200	5
5	22.0 X 400MM	ABL220	5
6	25.0 X 400MM	ABL250	5
<hr/>			
1	13.0 X 100MM	ABS130	5
2	16.0 X 100MM	ABS160	5
3	20.0 X 100MM	ABS200	5
4	25.0 X 100MM	ABS250	5
5	12.0 X 235MM	AB120	5
6	16.0 X 235MM	AB160	1



425MM MODULE SELECTION (STANDARD)



Stock Profile-Single Module			
	TYPE/SIZE (MM)	PRODUCT CODE	Qty
1	20.0 X 235MM	AB200	5
2	18.0 X 235MM	AB180	5
3	10.0 X 235MM	AB100	5
4	12.0 X 235MM	AB120	5
5	16.0 X 235MM	AB160	5
6	25.0 X 235MM	AB250	5
7	12.0 X 400MM	ABL120	5
8	16.0 X 400MM	ABL160	5
9	18.0 X 400MM	ABL180	5
<hr/>			
1	20.0 X 400MM	ABL200	5
2	22.0 X 400MM	ABL220	5
3	25.0 X 400MM	ABL250	5
4	13.0 X 100MM	ABS130	5
5	16.0 X 100MM	ABS160	5
6	20.0 X 100MM	ABS200	5
7	25.0 X 100MM	ABS250	5
8	12.0 X 400MM	ABL120	5
9	16.0 X 400MM	ABL160	5
<hr/>			
1	12.0 X 400MM	ABL120	5
2	16.0 X 400MM	ABL160	5
3	18.0 X 400MM	ABL180	5
4	20.0 X 400MM	ABL200	5
5	22.0 X 400MM	ABL220	5
6	25.0 X 400MM	ABL250	5
7	13.0 X 100MM	ABS130	5
8	16.0 X 100MM	ABS160	5
9	20.0 X 100MM	ABS200	5

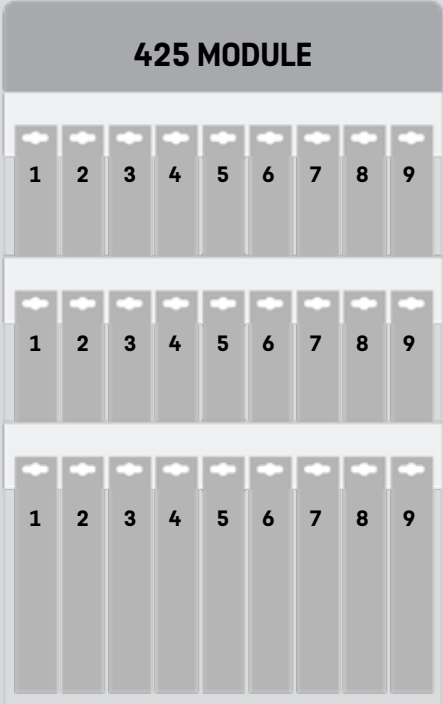

AUGER DRILL BIT

SAFELINE

AREA 1

STANDARD



CODE	DIM (MM)	PER
AB 60	6.0 X 235	
AB 70	7.0 X 235	
AB 80	8.0 X 235	
AB100	10.0 X 235	
AB120	12.0 X 235	
AB130	13.0 X 235	
AB140	14.0 X 235	
AB150	15.0 X 235	
AB160	16.0 X 235	
AB180	18.0 X 235	
AB190	19.0 X 235	
AB200	20.0 X 235	
AB220	22.0 X 235	
AB240	24.0 X 235	
AB250	25.0 X 235	

LONG



CODE	DIM (MM)	PER
ABL80	8.0 X 400	
ABL100	10.0 X 400	
ABL120	12.0 X 400	
ABL130	13.0 X 400	
ABL140	14.0 X 400	
ABL160	16.0 X 400	
ABL180	18.0 X 400	
ABL200	20.0 X 400	
ABL220	22.0 X 400	
ABL250	25.0 X 400	
ABL320	32.0 X 400	

SHORT



CODE	DIM (MM)	PER
ABS130	13.0 X 100	
ABS160	16.0 X 100	
ABS200	20.0 X 100	
ABS250	25.0 X 100	
ABS320	32.0 X 100	

SDS



SDS		
CODE	DIM (MM)	PER
ABSDS80	8.0 X 235	
ABSDS100	10.0 X 235	
ABSDS120	12.0 X 235	
ABSDS130	13.0 X 235	
ABSDS140	14.0 X 235	
ABSDS160	16.0 X 235	
ABSDS180	18.0 X 235	
ABSDS200	20.0 X 235	
ABSDS220	22.0 X 235	
ABSDS250	25.0 X 235	
ABSDS320	32.0 X 235	

FLAT WOOD BIT



FLAT WOOD BIT



AREA 4



CLEAN CUT



HEX SHANK

WOOD



STAND DETAILS

- 1.20 metre wide stand with 9 removable module.
- 6 pieces 375mm Modules
- 3 pieces 425mm Modules

BANNER LABELS

This helps customers to easily identify what kind of material it cuts and what power tool fixture it

49mm X 375mm Modules



49mm X 425mm Modules



AREA 4

FLAT WOOD BIT

CODE	DIMENSIONS (MM)	PER
4006	6mm	
4008	8mm	
4010	10mm	
4012	12mm	
4013	13mm	
4016	16mm	
4018	18mm	
4019	19mm	
4020	20mm	
4022	22mm	
4025	25mm	
4028	28mm	
4032	32mm	
4035	35mm	
4038	38mm	

SIZE

13mm
150mm



HARDWOOD SOFTWOOD

CODE: CO015



MATERIAL

CODE

BARCODE

375MM MODULE SELECTION



Stock Profile-Single Module

	TYPE/SIZE (MM)	PRODUCT CODE	Qty
1	Flat Wood Bit 28.0	4028	4
2	Flat Wood Bit 26.0	4026	4
3	Flat Wood Bit 32.0	4032	12
4	Flat Wood Bit 35.0	4035	4
5	Flat Wood Bit 38.0	4038	4
6	12" Extension	4040	4
1	Flat Wood Bit 16.0	4016	16
2	Flat Wood Bit 18.0	4018	5
3	Flat Wood Bit 19.0	4019	4
4	Flat Wood Bit 20.0	4020	16
5	Flat Wood Bit 22.0	4022	4
6	Flat Wood Bit 25.0	4025	16
1	Flat Wood Bit 6.0	4006	4
2	Flat Wood Bit 8.0	4008	5
3	Flat Wood Bit 10.0	4010	12
4	Flat Wood Bit 12.0	4012	12
5	Flat Wood Bit 13.0	4013	5
6	Flat Wood Bit 14.0	4014	5

375 MODULE



425MM MODULE SELECTION



Stock Profile-Single Module

	TYPE/SIZE (MM)	PRODUCT CODE	Qty
1	Flat Wood Bit 20.0	4020	15
2	Flat Wood Bit 22.0	4022	4
3	Flat Wood Bit 25.0	4025	16
4	Flat Wood Bit 26.0	4026	3
5	Flat Wood Bit 28.0	4028	3
6	Flat Wood Bit 32.0	4032	12
7	Flat Wood Bit 35.0	4035	3
8	Flat Wood Bit 38.0	4038	3
9	12" Extension	4040	3
1	Flat Wood Bit 6.0	4006	3
2	Flat Wood Bit 8.0	4008	5
3	Flat Wood Bit 10.0	4010	5
4	Flat Wood Bit 12.0	4012	5
5	Flat Wood Bit 13.0	4013	4
6	Flat Wood Bit 14.0	4014	5
7	Flat Wood Bit 16.0	4016	16
8	Flat Wood Bit 18.0	4018	4
9	Flat Wood Bit 19.0	4019	4
1	Flat Wood Bit 6.0	4006	7
2	Flat Wood Bit 8.0	4008	5
3	Flat Wood Bit 10.0	4010	5
4	Flat Wood Bit 12.0	4012	4
5	Flat Wood Bit 13.0	4013	3
6	Flat Wood Bit 14.0	4014	3
7	Flat Wood Bit 16.0	4016	4
8	Flat Wood Bit 18.0	4018	4
9	Flat Wood Bit 19.0	4019	3

425 MODULE

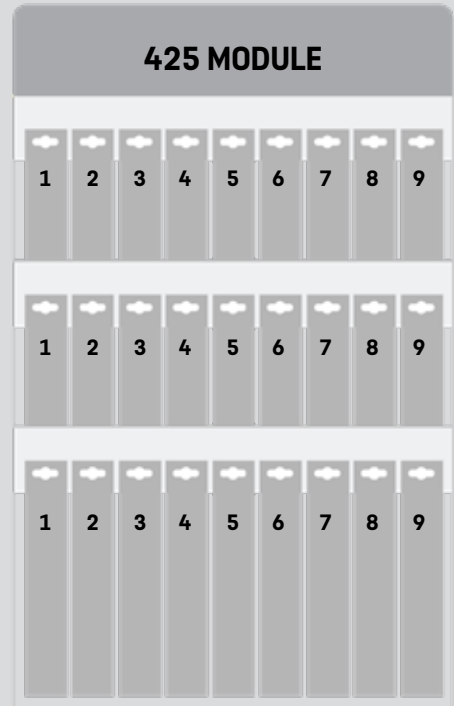

SDS DRILL BIT



AREA 5 & 6

STAND DETAILS

- 1.20 metre wide stand with 9 removable module.
- 6 pieces 375mm Modules
- 3 pieces 425mm Modules

BANNER LABELS

This helps customers to easily identify what kind of material it cuts and what power tool fixture it

49mm X 375mm Modules



49mm X 425mm Modules



AREA 4

SDS DRILL BIT

CODE	DIMENSIONS (MM)	PER
SD50110	5.0MM X 110 S.D.S DRILL BITS	
SD50160	5.0MM X 160 S.D.S DRILL BITS	
SD50210	5.0MM X 210 S.D.S DRILL BITS	
SD55110	5.5MM X 110 S.D.S DRILL BITS	
SD55160	5.5MM X 160 S.D.S DRILL BITS	
SD55210	5.5MM X 210 S.D.S DRILL BITS	
SD60110	6.0MM X 110 S.D.S DRILL BITS	
SD60160	6.0MM X 160 S.D.S DRILL BITS	
SD60210	6.0MM X 210 S.D.S DRILL BITS	
SD60260	6.0MM X 260 S.D.S DRILL BITS	
SD60310	6.0MM X 310 S.D.S DRILL BITS	
SD65160	6.5MM X 160 S.D.S DRILL BITS	
SD65210	6.5MM X 210 S.D.S DRILL BITS	
SD70210	7.0MM X 210 S.D.S DRILL BITS	



SIZE

MATERIAL QUALITY
FITTING IDENTIFIER

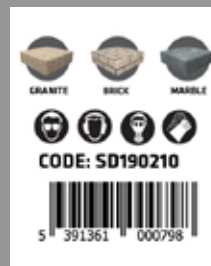

MATERIAL CODE
BARCODE

CODE	DIMENSIONS (MM)	PER
SD80110	8.0MM X 110 S.D.S DRILL BITS	
SD80160	8.0MM X 160 S.D.S DRILL BITS	
SD80210	8.0MM X 210 S.D.S DRILL BITS	
SD80260	8.0MM X 260 S.D.S DRILL BITS	
SD80310	8.0MM X 310 S.D.S DRILL BITS	
SD100160	10.0MM X 160 S.D.S DRILL BITS	
SD100210	10.0MM X 210 S.D.S DRILL BITS	
SD100260	10.0MM X 260 S.D.S DRILL BITS	
SD100310	10.0MM X 310 S.D.S DRILL BITS	
SD120160	12.0MM X 160 S.D.S DRILL BITS	
SD120210	12.0MM X 210 S.D.S DRILL BITS	
SD140210	14.0MM X 210 S.D.S DRILL BITS	
SD160210	16.0MM X 210 S.D.S DRILL BITS	

HSS DRILL BIT



375MM MODULE SELECTION



Stock Profile-Single Module			
	TYPE/SIZE (MM)	PRODUCT CODE	Qty
1	5.0 X 110	SD50110	6
2	5.0 X 160	SD50160	6
3	5.0 X 210	SD50210	4
4	5.5 X 110	SD55110	4
5	5.5 X 160	SD55160	8
6	5.5 X 210	SD55210	8
1	6.0 X 110	SD60110	8
2	6.0 X 160	SD60160	8
3	6.0 X 210	SD60210	8
4	6.0 X 260	SD60260	4
5	6.0 X 310	SD60310	8
6	6.5 X 160	SD65160	6
1	6.5 X 210	SD65210	6
2	7.0 X 210	SD70210	4
3	8.0 X 110	SD80110	4
4	8.0 X 160	SD80160	8
5	8.0 X 210	SD80210	8
6	8.0 X 260	SD80260	6



425MM MODULE SELECTION



Stock Profile-Single Module			
	TYPE/SIZE (MM)	PRODUCT CODE	Qty
1	5.0 X 110	SD50110	6
2	5.0 X 160	SD50160	6
3	5.0 X 210	SD50210	4
4	5.5 X 110	SD55110	4
5	5.5 X 160	SD55160	8
6	5.5 X 210	SD55210	8
7	6.0 X 110	SD60110	8
8	6.0 X 160	SD60160	8
9	6.0 X 210	SD60210	8
1	6.0 X 260	SD60260	4
2	6.0 X 310	SD60310	8
3	6.5 X 160	SD65160	6
4	6.5 X 210	SD65210	6
5	7.0 X 210	SD70210	4
6	8.0 X 110	SD80110	4
7	8.0 X 160	SD80160	8
8	8.0 X 210	SD80210	8
9	8.0 X 260	SD80260	6
1	8.0 X 310	SD80310	8
2	10.0 X 160	SD100160	6
3	10.0 X 210	SD100210	6
4	10.0 X 260	SD100260	4
5	10.0 X 310	SD100310	4
6	12.0 X 160	SD120160	6
7	12.0 X 210	SD120210	8
8	14.0 X 210	SD140210	6
9	16.0 X 210	SD160210	6

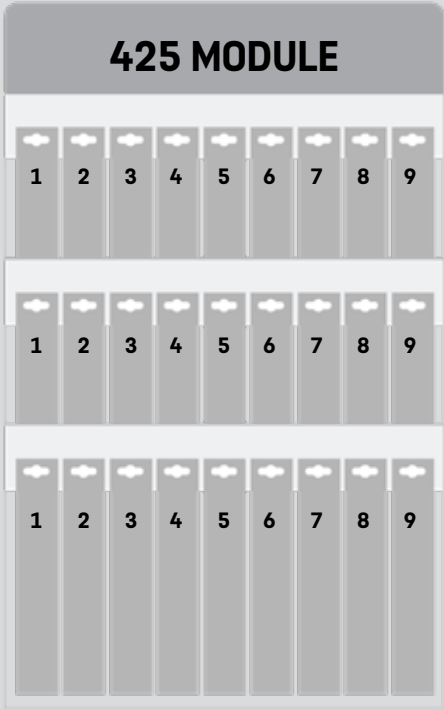

SDS DRILL BIT



SDS PLUS



2 CUTTING EDGES

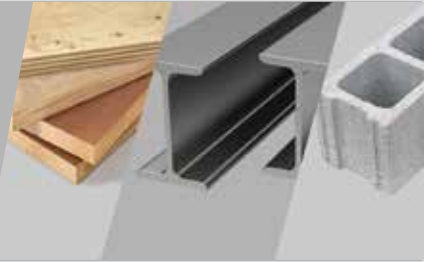

SDS DRILL BIT



SDS PLUS DRILL BIT

CODE	DIM (MM)	PER
SD40110	4.0 X 110	
SD40160	4.0 X 160	
SD50110	5.0 X 110	
SD50160	5.0 X 160	
SD50210	5.0 X 210	
SD55110	5.5 X 110	
SD55160	5.5 X 160	
SD55210	5.5 X 210	
SD60110	6.0 X 110	
SD60160	6.0 X 160	
SD60210	6.0 X 210	
SD60260	6.0 X 260	
SD60310	6.0 X 310	
SD65110	6.5 X 110	
SD65160	6.5 X 160	
SD65210	6.5 X 210	
SD65260	6.5 X 260	
SD65310	6.5 X 310	
SD70110	7.0 X 110	
SD70160	7.0 X 160	
SD70210	7.0 X 210	
SD8001000	8.0 X 1000	
SD80110	8.0 X 110	
SD80160	8.0 X 160	
SD80210	8.0 X 210	
SD80260	8.0 X 260	
SD80310	8.0 X 310	
SD80360	8.0 X 360	
SD80450	8.0 X 450	
SD80600	8.0 X 600	
SD90110	9.0 X 110	
SD90160	9.0 X 160	
SD90210	9.0 X 210	
SD1001000	10.0 X 1000	

CODE	DIM (MM)	PER
SD100110	10.0 X 110	
SD100160	10.0 X 160	
SD100210	10.0 X 210	
SD100260	10.0 X 260	
SD100310	10.0 X 310	
SD100360	10.0 X 360	
SD100450	10.0 X 450	
SD100600	10.0 X 600	
SD110110	11.0 X 110	
SD110160	11.0 X 160	
SD110210	11.0 X 210	
SD1201000	12.0 X 1000	
SD120110	12.0 X 110	
SD120160	12.0 X 160	
SD120210	12.0 X 210	
SD120260	12.0 X 260	
SD120310	12.0 X 310	
SD120360	12.0 X 360	
SD120450	12.0 X 450	
SD120600	12.0 X 600	
SD130160	13.0 X 160	
SD130210	13.0 X 210	
SD130250	13.0 X 250	
SD130260	13.0 X 260	
SD1401000	14.0 X 1000	
SD140160	14.0 X 160	
SD140210	14.0 X 210	
SD140260	14.0 X 260	
SD140310	14.0 X 310	
SD140450	14.0 X 450	
SD140600	14.0 X 600	
SD150160	15.0 X 160	
SD150210	15.0 X 210	
SD1601000	16.0 X 1000	

CODE	DIM (MM)	PER
SD160160	16.0 X 160	
SD160210	16.0 X 210	
SD160260	16.0 X 260	
SD160310	16.0 X 310	
SD160360	16.0 X 360	
SD160450	16.0 X 450	
SD160600	16.0 X 600	
SD170210	17.0 X 210	
SD1801000	18.0 X 1000	
SD180210	18.0 X 210	
SD180310	18.0 X 310	
SD180450	18.0 X 450	
SD180600	18.0 X 600	
SD190450	19.0 X 450	
SD2001000	20.0 X 1000	
SD200210	20.0 X 210	
SD200310	20.0 X 310	
SD200450	20.0 X 450	
SD200600	20.0 X 600	
SD2201000	22.0 X 1000	
SD220250	22.0 X 250	
SD220450	22.0 X 450	
SD220600	22.0 X 600	
SD230250	23.0 X 250	
SD230450	23.0 X 450	
SD240250	24.0 X 250	
SD240450	24.0 X 450	
SD2501000	25.0 X 1000	
SD250250	25.0 X 250	
SD250450	25.0 X 450	
SD250600	25.0 X 600	
SD260250	26.0 X 250	
SD260450	26.0 X 450	

SDS DRILL BIT



SDS - MAX HAMMER DRILLS

CODE	DIMENSIONS (MM)	PER
MX12370	12 X 370	
MX12570	12 X 570	
MX14370	14 X 370	
MX14570	14 X 570	
MX16370	16 X 370	
MX16570	16 X 570	
MX18570	18 X 570	
MX20370	20 X 370	
MX20570	20 X 570	
MX22370	22 X 370	
MX22570	22 X 570	
MX24320	24 X 320	
MX24370	24 X 370	
MX24570	24 X 570	
MX25320	25 X 320	
MX25370	25 X 370	
MX25570	25 X 570	
MX25920	25 X 920	
MX26370	26 X 370	
MX28370	28 X 370	
MX28570	28 X 570	
MX30370	30 X 370	
MX30570	30 X 570	
MX32370	32 X 370	
MX32570	32 X 570	
MX38570	38 X 570	



SDS MAX



2 CUTTING EDGES

SDS DRILL SET 12 16 24 X1000MM

CODE	DIMENSIONS (MM)	PER
SD3PC	12, 15, 24, X1000MM	€ 21.43



MASONRY DRILL BIT

SAFELINE

MASONRY DRILL BIT



AREA 9

STAND DETAILS

- 1.20 metre wide stand with 9 removable modules.
- 6 pieces 375mm Modules
- 3 pieces 425mm Modules

BANNER LABELS

This helps customers to easily identify what kind of material it cuts and what power tool fixture it

49mm X 375mm Modules



49mm X 425mm Modules



AREA 9

MASONRY DRILL BIT

CODE	DIMENSIONS (MM)	PER
N06	4.0mm	
N08	4.5mm	
N08A	5.0mm	
N010	5.5mm	
N010A	6.0mm	
N012	6.5mm	
N014	7.0mm	
N016	8.0mm	
N018	9.0mm	



CARBIDE TRIP



ROUND SANK



BRICK



CONCRETE



SIZE

6mm



CONCRETE BRICK STONE

CODE: N010A



5 391361 001368

MATERIAL

CODE

BARCODE

CODE	DIMENSIONS (MM)	PER
N020	10.0mm	
N022	11.0mm	
N023	12.0mm	
N024	13.0mm	
N025	14.0mm	
N026	16.0mm	
N028	18.0mm	
N030	20.0mm	

375MM MODULE SELECTION



Stock Profile-Single Module			
	TYPE/SIZE (MM)	PRODUCT CODE	Qty
1	4.0mm	N06	4
2	4.5mm	N08	4
3	5.0mm	N08A	12
4	5.5mm	N010	4
5	6.0mm	N010A	4
6	6.5mm	N012	4
1	7.0mm	N014	16
2	8.0mm	N016	5
3	9.0mm	N018	4
4	10.0mm	N020	16
5	11.0mm	N022	4
6	12.0mm	N023	16
1	13.0mm	N024	4
2	14.0mm	N025	5
3	16.0mm	N026	12
4	18.0mm	N028	12
5	20.0mm	N030	5
6	4.0mm	N06	5



425MM MODULE SELECTION



Stock Profile-Single Module			
	TYPE/SIZE (MM)	PRODUCT CODE	Qty
1	4.0mm	N06	15
2	4.5mm	N08	4
3	5.0mm	N08A	16
4	5.5mm	N010	3
5	6.0mm	N010A	3
6	6.5mm	N012	12
7	7.0mm	N014	3
8	8.0mm	N016	3
9	9.0mm	N018	3
1	10.0mm	N020	3
2	11.0mm	N022	5
3	12.0mm	N023	5
4	13.0mm	N024	5
5	14.0mm	N025	4
6	16.0mm	N026	5
7	18.0mm	N028	16
8	20.0mm	N030	4
9	4.0mm	N06	4
1	6.0mm	N010A	7
2	6.5mm	N012	5
3	7.0mm	N014	5
4	8.0mm	N016	4
5	9.0mm	N018	3
6	10.0mm	N020	3
7	11.0mm	N022	4
8	12.0mm	N023	4
9	13.0mm	N024	3

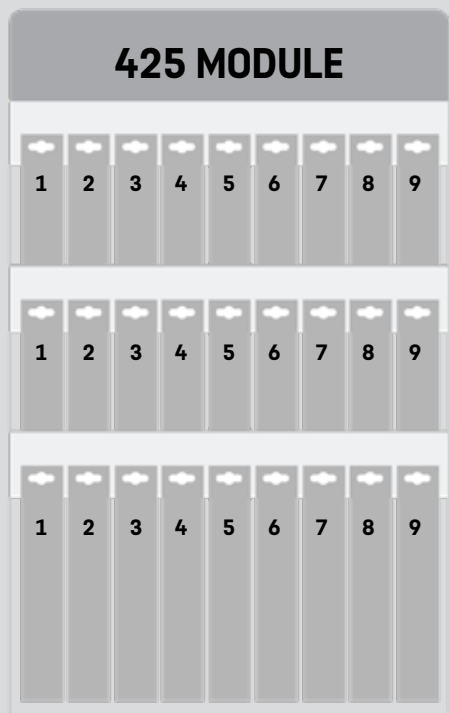

MASONRY DRILL BIT



MASONRY DRILL BIT

LONG MASONRY DRILL BIT

CODE	DIMENSIONS (MM)	PER
LM01A	6.5 X 400	
LM02	8.0 X 400	
LM03	10.0 X 400	
LM04	12.0 X 400	
LM06	16.0 X 400	

CODE	DIMENSIONS (MM)	PER
LM10	5.0 X 200	
LM11	5.5 X 200	
LM12	6.0 X 200	
LM13	6.5 X 200	
LM14	8.0 X 200	
LM15	10.0 X 200	
LM16	12.0 X 200	



**CARBIDE
TRIP**



**CARBIDE
TRIP**



**ROUND
SINK**



**ROUND
SINK**



HSS DRILL BIT



HSS DRILL BIT



AREA 2 & 3

STAND DETAILS

- 1.20 metre wide stand with 9 removable module.
- 6 pieces 375mm Modules
- 3 pieces 425mm Modules

BANNER LABELS

This helps customers to easily identify what kind of material it cuts and what power tool fixture it

49mm X 375mm Modules



49mm X 425mm Modules



AREA 4

HSS DRILL BIT

CODE	DIMENSIONS (MM)	PER
WD010	1.0mm	
WD015	1.5mm	
WD020	2.0mm	
WD025	2.5mm	
WD030	3.0mm	
WD035	3.5mm	
WD040	4.0mm	
WD042	4.2mm	
WD045	4.5mm	
WD050	5.0mm	
WD055	5.5mm	
WD060	6.0mm	
WD065	6.5mm	



SIZE

1.5mm



MATERIAL

CODE



BARCODE

CODE	DIMENSIONS	PER
WD070	7.0mm	
WD075	7.5mm	
WD080	8.0mm	
WD090	9.0mm	
WD095	9.5mm	
WD0100	10.0mm	
WD0105	10.5mm	
WD110	11.0mm	
WD0115	11.5mm	
WD0120	12.0mm	
WD0125	12.5mm	
WD0130	13.0mm	

375MM MODULE SELECTION



Stock Profile-Single Module

	TYPE/SIZE (MM)	PRODUCT CODE	Qty
1	1.0mm	WD010	4
2	1.5mm	WD015	4
3	2.0mm	WD020	12
4	2.5mm	WD025	4
5	3.0mm	WD030	4
6	3.5mm	WD035	4
1	4.0mm	WD040	16
2	4.2mm	WD042	5
3	4.5mm	WD045	4
4	5.0mm	WD050	16
5	5.5mm	WD055	4
6	6.0mm	WD060	16
1	6.5mm	WD065	4
2	7.0mm	WD070	5
3	7.5mm	WD075	12
4	8.0mm	WD080	12
5	8.5mm	WD085	5
6	9.0mm	WD090	5

375 MODULE



425MM MODULE SELECTION



Stock Profile-Single Module

	TYPE/SIZE (MM)	PRODUCT CODE	Qty
1	1.0mm	WD010	15
2	1.5mm	WD015	4
3	2.0mm	WD020	16
4	2.5mm	WD025	3
5	3.0mm	WD030	3
6	3.5mm	WD035	12
7	4.0mm	WD040	3
8	4.2mm	WD042	3
9	4.5mm	WD045	3
1	5.0mm	WD050	3
2	5.5mm	WD055	5
3	6.0mm	WD060	5
4	6.5mm	WD065	5
5	7.0mm	WD070	4
6	7.5mm	WD075	5
7	8.0mm	WD080	16
8	8.5mm	WD085	4
9	9.0mm	WD090	4
1	9.0mm	WD090	7
2	9.5mm	WD095	5
3	10.0mm	WD0100	5
4	10.5mm	WD0105	4
5	11.0mm	WD110	3
6	11.5mm	WD0115	3
7	12.0mm	WD0120	4
8	12.5mm	WD0125	4
9	13.0mm	WD0130	3

425 MODULE

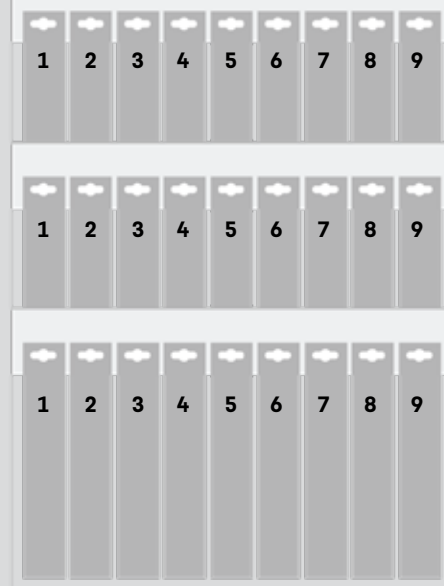

HSS DRILL BIT

SAFELINE

HSS DRILL BIT

LONG HSS DRILL DIN 340

CODE	DIM (MM)	PER
NHSL20	2.0 X 85.0	
NHSL25	2.5 X 95.0	
NHSL30	3.0 X 100.0	
NHSL35	3.5 X 112.0	
NHSL40	4.0 X 119.0	
NHSL45	4.5 X 126.0	
NHSL50	5.0 X 132.0	
NHSL55	5.5 X 139.0	
NHSL60	6.0 X 139.0	
NHSL65	6.5 X 148.0	
NHSL70	7.0 X 156.0	
NHSL75	7.5 X 156.0	
NHSL80	8.0 X 165.0	
NHSL85	8.5 X 165.0	
NHSL90	9.0 X 175.0	
NHSL95	9.5 X 175.0	
NHSL100	10.0 X 184	
NHSL105	10.5 X 184	
NHSL110	11.0 X 195	
NHSL115	11.5 X 195	
NHSL120	12.0 X 205.0	
NHSL125	12.5 X 205.0	
NHSL130	13.0 X 205.0	



PRE PACKED METRIC HSS BITS

CODE	DIM (MM)	PER
WD010	1.0mm	
WD015	1.5mm	
WD020	2.0mm	
WD025	2.5mm	
WD030	3.0mm	
WD035	3.5mm	
WD040	4.0mm	
WD042	4.2mm	
WD045	4.5mm	
WD050	5.0mm	
WD055	5.5mm	
WD060	6.0mm	
WD065	6.5mm	
WD070	7.0mm	
WD075	7.5mm	
WD080	8.0mm	
WD085	8.5mm	
WD090	9.0mm	
WD095	9.5mm	
WD0100	10.0mm	
WD0105	10.5mm	
WD110	11.0mm	
WD0115	11.5mm	
WD0120	12.0mm	
WD0125	12.5mm	
WD0130	13.0mm	



H.S.S DRILL BITS DIN 338 (10PCS)

CODE	DIM (MM)	PER	CODE	DIM (MM)	PER
HS1	1.0		HS65	6.5	
HS15	1.5		HS68	6.8	
HS20	2.0		HS70	7.0	
HS25	2.5		HS75	7.5	
HS30	3.0		HS80	8.0	
HS32	3.2		HS85	8.5	
HS33	3.3		HS90	9.0	
HS35	3.5		HS95	9.5	
HS40	4.0		HS100	10.0	
HS42	4.2		HS105	10.5	
HS45	4.5		HS110	11.0	
HS48	4.8		HS115	11.5	
HS50	5.0		HS120	12.0	
HS55	5.5		HS125	12.5	
HS60	6.0		HS130	13.0	
HS64	6.4				



COBALT DRILL BIT



AREA 7





CENTERED TIP ROUND SHANK METAL



COBALT DRILL BIT



STAND DETAILS

- 1.20 metre wide stand with 9 removable module.
- 6 pieces 375mm Modules
- 3 pieces 425mm Modules

BANNER LABELS

This helps customers to easily identify what kind of material it cuts and what power tool fixture it

49mm X 375mm Modules



49mm X 425mm Modules



SIZE





2mm

MATERIAL

CODE

BARCODE

MATERIAL

CODE

BARCODE

375MM MODULE SELECTION



Stock Profile-Single Module

	TYPE/SIZE (MM)	PRODUCT CODE	Qty
1	10.0MM	NC0100	4
2	10.5MM	NC0105	4
3	11.0MM	NC0110	12
4	11.5MM	NC0115	4
5	12.0MM	NC0120	4
6	12.5MM	NC0125	4
<hr/>			
1	13.0MM	NC0130	16
2	2.0MM	NC020	5
3	2.5MM	NC025	4
4	3.0MM	NC030	16
5	3.5MM	NC035	4
6	4.0MM	NC040	16
<hr/>			
1	4.5MM	NC045	4
2	5.0MM	NC055	5
3	5.5MM	NC060	12
4	6.0MM	NC065	12
5	6.5MM	NC070	5
6	7.0MM	NC080	5

375 MODULE

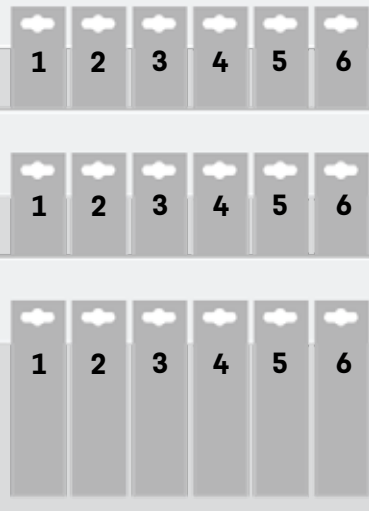

425MM MODULE SELECTION



Stock Profile-Single Module

	TYPE/SIZE (MM)	PRODUCT CODE	Qty
1	10.0MM	NC0100	15
2	10.5MM	NC0105	4
3	11.0MM	NC0110	16
4	11.5MM	NC0115	3
5	12.0MM	NC0120	3
6	12.5MM	NC0125	12
7	13.0MM	NC0130	3
8	2.0MM	NC020	3
9	2.5MM	NC025	3
<hr/>			
1	3.0MM	NC030	3
2	3.5MM	NC035	5
3	4.0MM	NC040	5
4	4.5MM	NC045	5
5	5.0MM	NC050	4
6	5.5MM	NC055	5
7	6.0MM	NC060	16
8	6.5MM	NC065	4
9	7.0MM	NC070	4
<hr/>			
1	8.0MM	NC080	7
2	9.0MM	NC090	5
3	9.5MM	NC095	5
4	2.0MM	NC020	4
5	2.5MM	NC025	3
6	3.0MM	NC030	3
7	3.5MM	NC035	4
8	4.0MM	NC040	4
9	4.5MM	NC045	3

425 MODULE

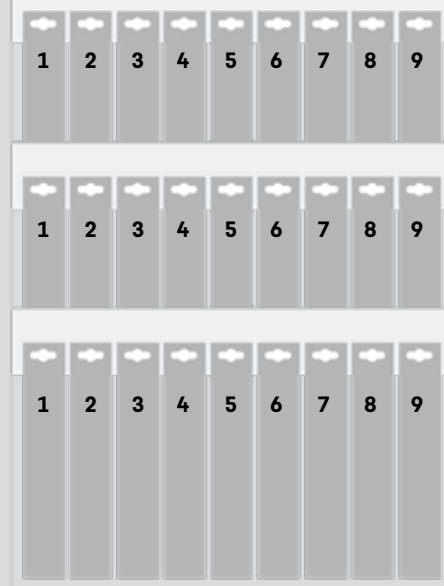

COBALT DRILL BIT



ROUND SHANK



CENTERED TIP

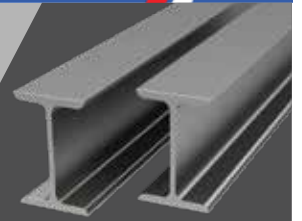

COBALT DRILL BIT

AREA 7

COBALT DRILL BITS (10PCS)

CODE	DIM (MM)	PER
C0010	1.0MM	
C0015	1.5MM	
C020	2.0MM	
C025	2.5MM	
C030	3.0MM	
C035	3.5MM	
C040	4.0MM	
C042	4.2MM	
C045	4.5MM	
C050	5.0MM	
C055	5.5MM	
C060	6.0MM	
C065	6.5MM	
C068	6.8MM	
C070	7.0MM	
C075	7.5MM	
C080	8.0MM	
C085	8.5MM	
C090	9.0MM	
C095	9.5MM	
C0100	10.0MM	
C0105	10.5MM	
C0110	11.0MM	
C0115	11.5MM	
C0120	12.0MM	
C0125	12.5MM	
C0130	13.0MM	



COBALT DRILL BIT

CODE	DIM (MM)	PER
NC0010	1MM	
NC015	1.5MM	
NC020	2.0MM	
NC025	2.5MM	
NC030	3.0MM	
NC035	3.5MM	
NC040	4.0MM	
NC042	4.2MM	
NC045	4.5MM	
NC050	5.0MM	
NC055	5.5MM	
NC060	6.0MM	
NC065	6.5MM	
NC068	6.8MM	
NC070	7.0MM	
NC075	7.5MM	
NC080	8.0MM	
NC085	8.5MM	
NC090	9.0MM	
NC095	9.5MM	
NC0100	10.0MM	
NC0105	10.5MM	
NC0110	11.0MM	
NC0115	11.5MM	
NC0120	12.0MM	
NC0125	12.5MM	
NC0130	13.0MM	



JIG SAW & SABRE SAW



JIG SAW BLADES



SABRE SAW BLADES



STAND DETAILS

- 1.20 metre wide stand with 9 removable modules.
- 6 pieces 375mm Modules
- 3 pieces 425mm Modules

BANNER LABELS

This helps customers to easily identify what kind of material it cuts and what power tool fixture it

49mm X 375mm Modules



49mm X 425mm Modules



AREA 7

JIG SAW BLADES

CODE	DIMENSIONS (MM)	PER
JST144D	BOSCH T144D JIG SAW BLADES FAST COARSE WOOD	
JST118A	BOSCH T118A JIG SAW BLADES SHEET METAL	
JST111C	BOSCH T111C JIG SAW BLADES FAST COARSE WOOD	
JST101B	BOSCH T101B JIG SAW BLADES CLEAN WOOD CUTTING	
JST101D	BOSCH T101D (5502) JIG SAW BLADES FOR WOOD	
JST127D	BOSCH T127D JIG SAW BLADES ALUMINIUM CUTTING	
JST119B	BOSCH T119B JIG SAW BLADES CHIPBOARD CUTTING	
JST119A	BOSCH T119A JIG SAW BLADES FOR WOOD	
JSTEK5	ASSORTED JIG SAW SET METAL/WOOD T144D T101B T101A0 T118A T118B	

SABRE SAW BLADES

CODE	DIMENSIONS (MM)	PER
JSEK114	12" (300MM) SABRESAW BLADES WOOD (PK5) CC	
JSEK102	6" (150MM) SABRESAW BLADES METAL (PK5)	
JSEK115	9" (225MM) SABRESAW BLADES METAL 9TPI (PK5)	
JSK117	6" SABRE SAW BLADE WOOD/PLASTERBOARD 6TPI	
JSEK104	6" SABRESAW BLADES PLAST/WOOD 10TPI (PK5)	
JSEK106	9" (230MM) SABRESAW BLADES WOOD 10TPI (PK5)	
JSEK116	12" (300MM) SABRESAW BLADES MILD STEEL (PK5)	

375MM MODULE SELECTION



Stock Profile-Single Module

	TYPE/SIZE (MM)	PRODUCT CODE	Qty
1	10.0MM	NC0100	4
2	10.5MM	NC0105	4
3	11.0MM	NC0110	12
4	11.5MM	NC0115	4
5	12.0MM	NC0120	4
6	12.5MM	NC0125	4
<hr/>			
1	13.0MM	NC0130	16
2	2.0MM	NC020	5
3	2.5MM	NC025	4
4	3.0MM	NC030	16
5	3.5MM	NC035	4
6	4.0MM	NC040	16
<hr/>			
1	4.5MM	NC045	4
2	5.0MM	NC055	5
3	5.5MM	NC060	12
4	6.0MM	NC065	12
5	6.5MM	NC070	5
6	7.0MM	NC080	5

375 MODULE



425MM MODULE SELECTION



Stock Profile-Single Module

	TYPE/SIZE (MM)	PRODUCT CODE	Qty
1	10.0MM	NC0100	15
2	10.5MM	NC0105	4
3	11.0MM	NC0110	16
4	11.5MM	NC0115	3
5	12.0MM	NC0120	3
6	12.5MM	NC0125	12
7	13.0MM	NC0130	3
8	2.0MM	NC020	3
9	2.5MM	NC025	3
<hr/>			
1	3.0MM	NC030	3
2	3.5MM	NC035	5
3	4.0MM	NC040	5
4	4.5MM	NC045	5
5	5.0MM	NC050	4
6	5.5MM	NC055	5
7	6.0MM	NC060	16
8	6.5MM	NC065	4
9	7.0MM	NC070	4
<hr/>			
1	8.0MM	NC080	7
2	9.0MM	NC090	5
3	9.5MM	NC095	5
4	2.0MM	NC020	4
5	2.5MM	NC025	3
6	3.0MM	NC030	3
7	3.5MM	NC035	4
8	4.0MM	NC040	4
9	4.5MM	NC045	3

425 MODULE



**DOMINATOR DRILL BIT
4HEAD PROFESSIONAL LONG LIFE BIT**



CODE	DIMENSIONS (MM)	PER
DSD50160	5.0 X 160	
DSD55160	5.5 x 160	
DSD55210	5.5 x 210	
DSD60160	6.0 x 160	
DSD60210	6.0 x 210	
DSD65210	6.5 x 210	
DSD80160	8.0 x 160	
DSD80210	8.0 x 210	
DSD80260	8.0 x 260	
DSD80310	8.0 x 310	
DSD100160	10.0 x 160	
DSD100210	10.0 x 210	
DSD120160	12.0 x 160	
DSD120210	12.0 x 210	

CODE	DIMENSIONS (MM)	PER
DSD140210	14.0 x 210	
DSD160210	16.0 x 210	
DSD65160	6.5 X 160	
DSD70210	7.0 X 210	
DSD50210	5.0 X 210	
DSD200210	20.0 X 210	
DSD200450	20.0 X 450	
DSD250450	25.0 X 450	
DSD120310	12.0 X 310	
DSD100310	10.0 X 310	
DSD180450	18.0 x 450	
DSD160450	16.0 x 450	
DSD80450	8.0 X 450	
DSD180210	18.0 X 210	
DSD100450	10.0 X 450	
DSD120450	12.0 X 450	
DSD60110	6.0 X 110	
DSD100260	10.0 X 260	



HIGH SPEED DRILLING



**DRILLS THROUGH
OVERSIZED REBAR**

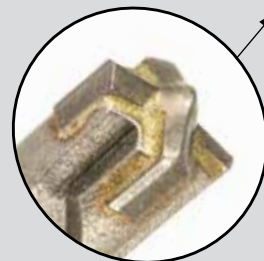

IDEAL FOR POWERFUL HAMMER DRILL



DRILLS THROUGH OVERSIZED REBAR



HIGH SPEED DRILLING

POZI BITS (3 PER CARD)



CODE	DIMENSIONS (MM)	PER
N5601	POZINO 1 (25MM)	
N5602	POZINO 2 (25MM)	
N5603	POZINO 3 (25MM)	
N5611	POZINO 1 (50MM)	
N5612	POZINO 2 (50MM)	
N5613	POZINO 3 (50MM)	

PHILIPS BITS (3 PER CARD)



CODE	DIMENSIONS (MM)	PER
N5606	PHILIPS NO 2 (25MM)	

S2 IMPACT BITS 25PCS



CODE	DIMENSIONS (MM)	PER
N5624	POZI 2 (25MM)	

ADAPTORS



CODE	DIMENSIONS (MM)	PER
N5620	1/4 ADAPTOR	
N5621	6.0 Nut Setter	
N5622	8.0 Nut Setter	
N5623	10.0 Nut Setter	

HINGE DRILLS HSS



CODE	DIMENSIONS (MM)	PER
HT35	35mm	

BLISTER PACK CHUCK KEY



CODE	DIMENSIONS (MM)	PER
N5652	13mm	
N5654	16mm	

CHUCK ADAPTOR & KEY SET



CODE	DESCRIPTION	PER
N5666	SDS CHUCK ADAPTOR	

PRE PACKED DRILL CHUCK & SDS



CODE	DESCRIPTION	PER
N5665	1- 13mm Female 1/2" 20 UNF keyed chuck (metal housing) with SDS plus adaptor	

BLISTER PACK KEYLESS CHUCK



CODE	DIMENSIONS (MM)	PER
N5660	13mm (1/2") X 20 UNF	
N5661	10mm (3/8") X 24 UNF	

BLISTER PACK KEYLESS CHUCK



CODE	DIMENSIONS (MM)	PER
N5650	12mm (1/2") X 20 UNF	

CORE DRILLS (COME COMPLETE WITH B, C, D)



CODE	DESCRIPTION	PER
SDSADP350	SDS PLUS CORE DRILL ADAPTOR	
SDSCD35	35MM COMP CORE SHELL SDS PLUS	
SDSCD40	40MM COMP CORE SHELL SDS PLUS	
SDSCD50	50MM SDS PLUS CORE DRILL COMPLETE	
SDSCD82	82MM COMP CORE SHELL SDS PLUS	
SDSCD110	110MM SDS PLUS CORE DRILL COMPLETE	

CODE	DIMENSIONS (MM)	PER
CD30	30mm	
CD35	35mm	
CD40	40mm	
CD45	45mm	
CD50	50mm	
CD55	55mm	
CD65	65mm	
CD76	76mm	
CD90	90mm	
CD100	100mm	
CD115	115mm	
CD125	125mm	
CD150	150mm	

DRYDIAMONDS CORE DRILLS



CODE	DIMENSIONS (MM)	PER
DC380	38MM DIA 150MM	
DC520	52MM DIA 150MM	
DC650	65MM DIA 150MM	
DC780	78MM DIA 150MM	
DC1070	107MM DIA 150MM	
DC1170	117MM DIA 150MM	
DC1270	127MM DIA 150MM	

SDS ARBOUR



CODE	DIMENSIONS (MM)	PER
HSDS01	SDS HOLESAW ARBOUR	
HSDS13	SDS HOLESAW ARBOUR	

PRE PACKED HOLESAW ARBOUR



CODE	DIMENSIONS (MM)	PER
HA01	SMALL ARBOUR A1	
HA02	LARGE ARBOUR A2	

ADAPTORS & ACCESSORIES



CODE	DESCRIPTION	PER
HA04	HOLE SAW ARBOUR EXTENSION	

PRE PACKED PILOT DRILL



CODE	DIMENSIONS (MM)	PER
HPD01	6.0 X 75 PILOT DRILL	
HPD02	6.0 X 105 PILOT DRILL	

SDS POINTS AND CHISELS



CODE	DIMENSIONS (MM)	PER
SD300	GOUGE 300MM	
SD400	POINT 400MM	
SD50300	CHISEL 50 X 300MM	

CODE	DIMENSIONS (MM)	PER
SD75300	CHISEL 75 X 300MM	
SD25400	CHISEL 25 X 400MM	

ADAPTORS & ACESSORIES



CODE	DIMENSIONS (MM)	PER
DC270	Extension Rod 150mm	
DC280	Extension Rod 250mm	

EXTENSION RODS & ACCESSORIES



HAMMER DRILL ADAPTORS

CODE	DESCRIPTION	PER
SDS-PLUS	SDS PLUS MACHINES	
SDS-Max	BOSCH SDS MAX MACHINES	

TILE & GLASS DRILL BIT



CODE	DIM (MM)	PER
NTD11	3.0mm Drills	
NTD12	4.0mm Drills	
NTD13	5.0mm Drills	
NTD14	6.0mm Drills	
NTD15	8.0mm Drills	

CODE	DIM (MM)	PER
NTD16	10.0mm Drills	
NTD18	12.0mm Drills	
NTD22	3/16 Drills	
NTD25	3/8 Drills	
NTD26	1/2 Drills	

PORCELAIN TILE CORE



CODE	DIMENSIONS (MM)	PER
NTD30	6.0mm Drill	
NTD31	8.0mm Drill	
NTD32	10.0mm Drill	
NTD33	12.0mm Drill	

MULTI-PURPOSE DRILL BIT

CODE	DIMENSIONS (MM)	PER
MDB5090	5.0mm X 90mm	
MDB5595	5.5mm X 95mm	
MDB60100	6.0mm X 100mm	
MDB80120	8.0mm X 120mm	



NEW SINGLE FLUTE DESIGN
 Unique single flute has 28% greater capacity meaning more efficient waste removal for higher speed performance

SURFACE
 Two-tone dark gold and silver finish for easier identification

SPEED
 Unique tip and flute design means 60% faster drilling than competing drill bits

UNIQUE POINT GRINDING

- Unique diamond ground 4-face carbide tip design
- Extreme low drilling pressure means faster drilling and up to 100% more holes per battery charge compared to competing drill bits
- Excellent centering - will not walk
- Perfect hole quality
- Long life

HOLESAWS

CODE	DIM (MM)	PER	CODE	DIM (MM)	PER
H1400	14mm		H570	57mm	
H160	16mm		H590	59mm	
H170	17mm		H600	60mm	
H190	19mm		H640	64mm	
H200	20mm		H650	65mm	
H210	21mm		H670	67mm	
H220	22mm		H680	68mm	
H240	24mm		H700	70mm	
H250	25mm		H730	73mm	
H270	27mm		H760	76mm	
H280	28mm		H790	79mm	
H290	29mm		H830	83mm	
H300	30mm		H860	86mm	
H320	32mm		H890	89mm	
H330	33mm		H920	92mm	
H350	35mm		H950	95mm	
H370	37mm		H980	98mm	
H380	38mm		H1020	102mm	
H400	40mm		H1050	105mm	
H410	41mm		H1080	108mm	
H430	43mm		H1110	111mm	
H440	44mm		H1140	114mm	
H460	46mm		H1210	121mm	
H480	48mm		H1270	127mm	
H510	51mm		H14000	140mm	
H520	52mm		H1460	146mm	
H540	54mm		H1520	152mm	



PLUMBERS HOLESAW KIT



CODE	DIMENSIONS (MM)	PER
KITP	<p>CONTENTS: 19mm (3/4"), 22mm (7/8"), 29mm (1-1/8"), 38mm (1-1/2"), 44mm (1-3/4"), 57mm (2-1/4") 1 LARGE ARBOUR 1 SMALL ARBOUR 1 REINFORCED METAL PLATE.</p>	

ELECTRICIANS HOLESAW KIT



CODE	DIMENSIONS (MM)	PER
KITE	<p>CONTENTS: 16mm (5/8"), 20mm (25/32"), 25mm (1"), 32mm (1-1/4"), 40mm (1-9/16"), 51mm (2") 1 LARGE ARBOUR 1 SMALL ARBOUR 1 REINFORCED METAL PLATE.</p>	

HAMMER & BREAKER STEELS

SUITABLE FOR USE WITH:
 KANGO 900, 950, HITACHI H55SA, DH50SA,
 DH38YD, SPIT 322, MAKITA HR5000 MAKITA
 HR3850K, HM1200K, OLDLYNE HD91, HD96, HITA-
 CHI H60KA

CODE	DESCRIPTION	PER
914112	POINT 15"	
914118	Chisel 15"	
914475	SCALING CHISEL 2" X 3"	
914476	SCALING CHISEL 3" X 3"	
914482	CHASING GOUGE 12"	

SUITABLE FOR USE WITH: HITACHI PH 65A,
 MAKITA HM1400, AKITA HM1300. MAKITA
 8900N, HM1300, RYOBI

CODE	DESCRIPTION	PER
914814T	SDS PLUS POINT	
914924T	SDS PLUS CHISEL	
914844T	SDS PLUS WIDE CHISEL	

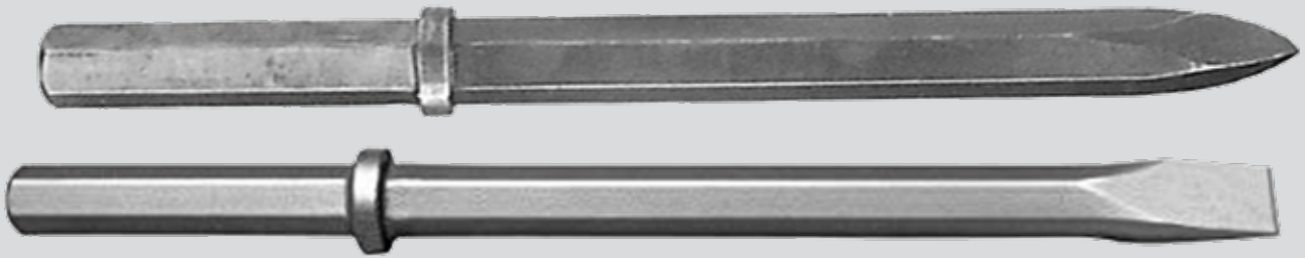

HAMMER & BREAKER STEELS

CODE	DESCRIPTION	PER
912668	CLAY SPADE	
912084	18 POINT 1 1/4 X 6 1/4	
912294	18 CHISEL 1 1/4 X 6 1/4	
914624	CHISEL 16 3/8"	



SDS MAX POINT & CHISELS



CODE	DIMENSIONS (MM)	PER
MCC12	12.0MM COBALT	
MCC14	14.0MM COBALT	
MCC16	16.0MM COBALT	
MCC18	18.0MM COBALT	
MCC20	20.0MM COBALT	
MCC22	22.0MM COBALT	
MCC24	24.0MM COBALT	
MCC25	25.0MM COBALT	
MCC26	26.0MM COBALT	
MCC28	28.0MM COBALT	
MCC30	30.0MM COBALT	
MCC32	32.0MM COBALT	

CODE	DIMENSIONS (MM)	PER
MCCL12	12.0MMLONG SERIES	
MCCL14	14.0MM LONG SERIES	
MCCL16	16.0MM LONG SERIES	
MCCL18	18.0MM LONG SERIES	
MCCL19	19.0MM LONG SERIES	
MCCL20	20.0MM LONG SERIES	
MCCL22	22.0MM LONG SERIES	
MCCL24	24.0MM LONG SERIES	
MCCL25	25.0MM LONG SERIES	
MCCL26	26.0MM LONG SERIES	
MCCL28	28.0MM LONG SERIES	
MCCL30	30.0MM LONG SERIES	
MCCL32	32.0MM LONG SERIES	

CODE	DIMENSIONS (MM)	PER
MCH12	12.0MM HSS	
MCH13	13.0MM HSS	
MCH14	14.0MM HSS	
MCH15	15.0MM HSS	
MCH16	16.0MM HSS	
MCH17	17.0MM HSS	
MCH18	18.0MM HSS	
MCH19	19.0MM HSS	
MCH20	20.0MM HSS	
MCH21	21.0MM HSS	
MCH22	22.0MM HSS	
MCH23	23.0MM HSS	
MCH24	24.0MM HSS	
MCH25	25.0MM HSS	
MCH26	26.0MM HSS	
MCH27	27.0MM HSS	
MCH28	28.0MM HSS	
MCH29	29.0MM HSS	
MCH30	30.0MM HSS	
MCH31	31.0MM HSS	
MCH32	32.0MM HSS	

CODE	DIMENSIONS (MM)	PER
LP	LONG PINS	
SP	SHORT PINS	

BLACKSMITH DRILLS 13MM (1/2") REDUCED SHANK



CODE	DIM (MM)	PER
BS33	17/32	
BS34	9/16	
BS35	19/32	
BS36	5/8	
BS37	21/32	
BS38	11/16	
BS39	23/32	
BS40	3/4	
BS42	13/16	
BS43	27/32	
BS44	7/8	

CODE	DIM (MM)	PER
BS45	29/32	
BS46	15/16	
BS47	31/32	
BS48	1	
BS14.0	14.0MM	
BS14.5	14.5MM	
BS15.0	15.0MM	
BS15.5	15.5MM	
BS16.0	16.0MM	
BS16.5	16.5MM	
BS17.0	17.0MM	

CODE	DIM (MM)	PER
BS17.5	17.5MM	
BS18.0	18.0MM	
BS20.0	20.0MM	
BS21.5	21.5MM	
BS23.5	23.5MM	
BS24.5	24.5MM	
BS25.0	25.0MM	

TAPES



SAFELINE ADHESIVE TAPES

TAPES

TAPES



SAFELINE CLEAR PACKING TAPE

CODE	SIZE	BX QTY	(1)
AT26	50MM X 50MTR	36	



SAFELINE BROWN PACKING TAPE

CODE	SIZE	BX QTY	(1)
AT23	50MM X 50MTR	36	



HIGHLY VISIBLE ANTI-SLIP TAPE that solves slip issues and helps to warn of an impending hazard.

FEATURES

- Anti-Slip
- Easy to Apply
- Great for Stair Nosings
- Black & Yellow Striped Tape
- For Internal & External Use
- Self-Adhesive
- Durable
- Long Length Roll for Various Uses

ANTI-SLIP TAPE

CODE	SIZE	COLOUR	PER 1	BOX QTY
AT38	50MM X 20MTR	BLACK & YELLOW		24



TAPES

TAPES

ALUMINIUM FOIL TAPE is a 30u nominal dead soft aluminium foil with aggressive flame-retardant acrylic adhesive and protected by easy release liner.

FEATURES

Excellent Peel Adhesion Good Initial Tack & Permanent Bonding UL723 Fire Rating Approval, Outstanding Temperature & Aging Resistance

APPLICATIONS

Super performance, UL 723 FR grade 30u foil tape. Ideal for sealing joints/seams against moisture and vapour on foil jacketing insulation. Suitable for many other permanent sealing, holding, splicing or masking applications requiring the protection offered by a foil backing.

SAFELINE FIRE RATED ALUMINIUM FOIL TAPE

CODE	SIZE	BX QTY	PRICE
AT06	75mmX50 MTR	24	
AT06A	50mm X 50MTR	36	



SELF ADHESIVE SCRIM TAPE is used to tape over joints before skimming plasterboard. It's flexible to prevent bubbling which gives it a cleaner finish. Our hand jointing tape adds more lateral strength than scrim and mesh tape so it's much less prone to crack. If its sculptures and moulds you're working on then brown jute is what you are looking for to help reinforce your project. Finally our acoustic impact strip is designed to create good impact on sound insulation as it absorbs floor unevenness

SAFELINE FIBRE SCRIM

CODE	SIZE	BX QTY	PRICE
AT35	50mmX90MTR	36	
AT58	75mm x 90MTR	27	
AT48	100mm x 90MTR	12	

MASKING TAPES

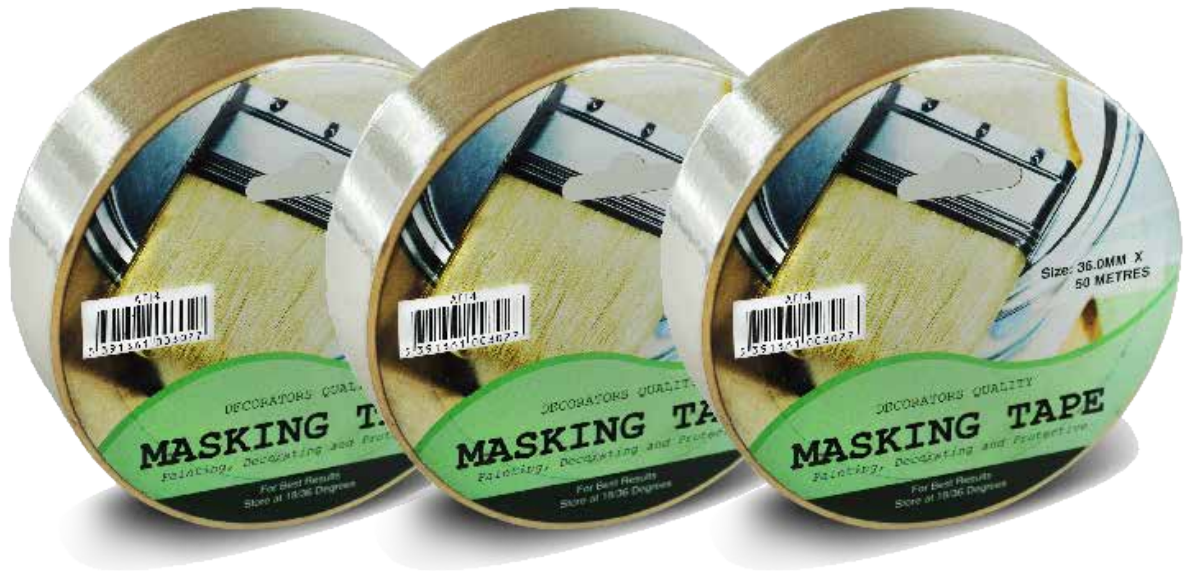

TAPES

TAPES

CODE	DESCRIPTION	PRICE	BX QTY
AT13	24mm X 50mtr MASKING TAPE		72
AT14	36mm X 50mtr MASKING TAPE		48
AT15	48mm X 50mtr MASKING TAPE		36
AT16	72mm X 50mtr MASKING TAPE		24



CODE	DESCRIPTION	PRICE	BX QTY
AT07	24mm X 50mtr UV MASKING TAPE		72
AT08	36mm X 50mtr UV MASKING TAPE		48
AT09	48mm X 50mtr UV MASKING TAPE		36

SAFELINE DUCT TAPE

FREE DISPLAY BOX!



TAPES

TAPES

SAFELINE CLOTH DUCT TAPE

CODE	DESCRIPTION	PRICE	BOX QTY
AT27	50MM X25MTR		48
AT28	50MM X 50MTR		36
AT29	50MM X 10MTR		48
AT30	75MM X 50MTR		24

SAFELINE PVC BLACK TAPE (NOT CLOTH)

CODE	DESCRIPTION	PER 1	BOX QTY
AT52	50MM X50 MTR		36

SAFELINE BLACK CLOTH DUCT TAPE

CODE	DESCRIPTION	PER 1	BOX QTY
AT28B	50MM X 50MTR		36





TAPES

TAPES

PT.F.E TAPES

CODE	SIZE	DESCRIPTION	PER 1	BOX QTY
AT04	12mm x 10mtr	WHITE WRC APPROVED		250
AT05	12.7mm x 6mtr	YELLOW GAS BSEN 751/2/3		250



PVC ELECTRICAL TAPE (20M LONG) BS STANDARD

CODE	WIDTH	PER ROLL	PK SIZE	COLOUR
AT6009	19MM		10	Black
AT6010	19MM		10	Red
AT6011	19MM		10	Light Green
AT6012	19MM		10	Light Blue
AT6013	19MM		10	Yellow
AT6014	19MM		10	White
AT6015	19MM		10	Brown
AT6016	19MM		10	Yellow/Green
AT6017	19MM		10	Grey



TAPES

TAPES

ADHESIVE FLOOR MARKING TAPE

CODE	SIZE	COLOUR	PER 1	BOX QTY
AT40	50MM X 50MTR	YELLOW/BLACK		18
AT41	50MM X 50MTR	RED/WHITE		18



WARNING TAPE

CODE	SIZE	COLOUR	PER 1	BOX QTY
AT43	75MM X 500MTR	RED & WHITE		12
AT44	75MM X 500MTR	BLACK & YELLOW		12

FRAGILE TAPE

CODE	SIZE	COLOUR	PER 1	BOX QTY
AT20	50MM x 66MTR	FRAGILE TAPE		36





Black pallet wrap offers privacy for you and your customers, blocks out any information.



Clear pallet wrap is ideal for use in your own warehouse, keep goods together while allowing you to see what is stored on the pallet.

PALLET WRAP

CODE	DESCRIPTION	PER ROLL	BOX QTY
AT47	CLEAR 400 X 200M X 17 MICRON		6
AT50	BLACK 400 X 200M X 17 MICRON		6



PVC TAPE FOR CONCRETE INSULATION

CODE	DESCRIPTION	PER ROLL	BOX QTY
AT33	YELLOW 50 MM X 33 M		36
AT34	BLACK 50MM X 33 M		36

SILAGE TAPE

CODE	SIZE	COLOUR	PER 1	BOX QTY
AT31	75MM X 20MTR	BLACK		24

UNDERGROUND & WARNING TAPES

TAPES



TAPES



UNDERGROUND TAPES 150MM X 365 MTRS

CODE	DESCRIPTION	PER ROLL	10 ROLLS
WT01	CAUTION WATER PIPE BELOW		10.95
WT02	CAUTION TELEPHONE CABLE BELOW		10.95
WT03	CAUTION ELECTRICAL CABLE BELOW		10.95
WT04	CAUTION BURIED GAS PIPE		10.95
WT05	SEWER PIPE BELOW		10.95
WT16	STREET LIGHT CABLE BELOW		10.95
WT17	CAUTION FIBRE OPTIC CABLE BELOW		10.95
WT24	CAUTION SERVICES BELOW		10.95



TAPES

TAPES

DETECTAMESH™ DETECTABLE TAPE is a plastic mesh with a traceable stainless steel wire laminated between the mesh and a polyethylene tape which is printed with a warning message to warn future excavators of the location and potential danger of the utility services / pipes and cables below (Water Main, Gas Pipe, Electric Cable etc). The stainless steel wire acts as the detectable element that can be located by a CAT & GENNY (cable avoidance tool / cable and pipe locator) by direct connection or induction where applicable. Plastic mesh is manufactured to BS EN 12613:2001

Detectamesh™ detectable tape is suitable for:

- marking energised and unenergised electric power cables
- marking fibre optic cables
- marking plastic gas and water pipes
- for locating services by using a cat and genny cable avoidance tool

200MM X 100M DETECTAMESH STREET LIGHT BELOW

CODE	DESCRIPTION	PER ROLL
WT06	CAUTION TELEPHONE CABLE BELOW	
WT07	CAUTION ELECTRICAL CABLE BELOW	
WT08	CAUTION BURIED GAS PIPE	
WT10	CAUTION WATER PIPE BELOW	
WT12	CAUTION SEWER PIPE BELOW	
WT25	CAUTION STREET LIGHT CABLE	

400MM WIDE DETECTAMESH TAPE "IRISH WATER SPEC"

WT26	CAUTION WATER PIPE BELOW	
WT30	CAUTION SEWER PIPE BELOW	

TAPES

TAPES



E.S.B APPROVED WARNING TAPE

CODE	DESCRIPTION	PER ROLL
WT14	250MMX0.1 X 200MTR (2955090)	
WT15	500MM X 0.1 X 200MTR (2955092)	

TILE TAPE

CODE	DESCRIPTION	PER TILE
AT39	200MM X 20MTR TILE TAPE(ESB NO 2955101)	
AT57	400MM X 20MTR TILE TAPE(ESB NO 2955103)	

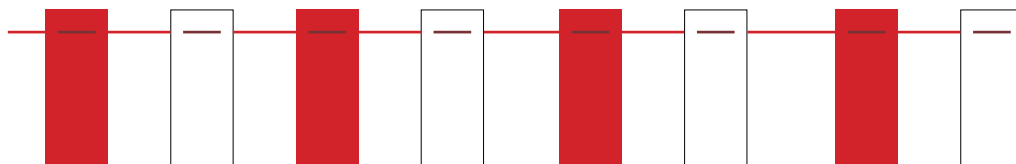

BUNTING

CODE	DESCRIPTION	PER BAG
WT11	RED & WHITE 26M LONG	

SAFETY





SAFETY

SAFETY



FFP3 DUST MASK

**5PC
PACK**

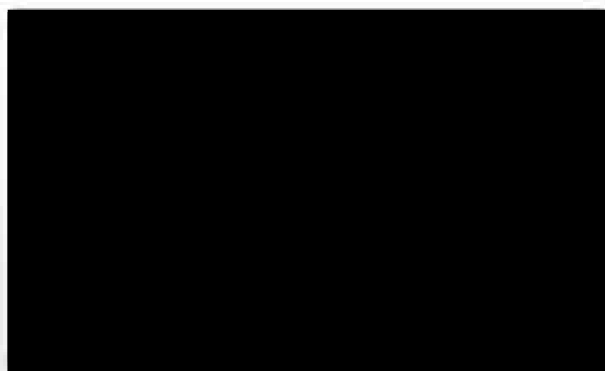

CODE: SE 1092



SAFETY

FFP2 - VALVED RESPIRATOR MASK

- ✓ Tight Sealed
- ✓ Comfortable Use
- ✓ Latex-Free Head Strap
- ✓ High Filter Efficiency
- ✓ Dust, Pollen Protection
- ✓ Disposable Particulate Respirator

3 PCS PER PACK
RETAIL PACK

SE125758C



SAFETY



10 PCS PER PACK
RETAIL PACK

SE125758B



SAFETY

FFP3 - VALVED DUST MASK

- ✓ Tight Sealed
- ✓ Comfortable Use
- ✓ Latex-Free Head Strap
- ✓ High Filter Efficiency
- ✓ Dust, Pollen Protection
- ✓ Disposable Particulate Respirator

3 PCS PER PACK
RETAIL PACK

SE135758



DISPOSABLE MASK

SAFETY

**SE1230** (BOXED IN 50)**SE1230PP** PRE PACKED PK 10

PPE offer



MX2005B

FOLD FLAT MASK (K95)

**BUY 500pcs
GET 100pcs FREE**



MX2004

CLEAR FACE VISOR KIT

**BUY 60pcs
GET 12pcs FREE**



MX2005C

3PLY BLUE MASK

**BUY 1800
GET 200 FREE**

SAFETY

SAFETY

GEL KNEE PADS

WITH GEL CORE AND REINFORCED CAP



Adjustable Elasticated Straps

CODE: TL627

Breathable Mesh Interior

Tread Pattern on Cap for Added Grip

SAFETY

KNEE PADS

CODE: TL627A



- ARTICULATED DESIGN
- ONE SIZE FITS ALL
- FIT RIGHT OR CUT TO SIZE
- INCREASED COMFORT AND FLEXIBILITY

SAFETY ESSENTIALS



SITE SAFETY ✓



Wash your hands regularly



Avoid contact



Keep a safe distance of at least 2 metres



Avoid touching your face



Cough or sneeze into the crease of the elbow or in a tissue



Stay at home if you are ill

COVID SAFETY SIGN
32" x 24

CODE: COVID SIGN



**VORTEX
BLACK LENSE**
CODE: SE2609



**BOLLE CLEAR
SPEC WITH
CORD**
CODE: MX2009B

SAFETY ESSENTIALS



GOGGLES
CODE: SE1112C



**BLUE FRAME
SPEC**
CODE: MX2009A



OVER SPEC
CODE: MX2003



**CORDED
SPEC**
CODE: MX2008

SAFETY ESSENTIALS



**CLEAR FACE
VISOR KIT**
CODE: MX2004



**UNIVERSAL
HELMET VISOR**
CODE: MX2004D



COVID VEST
CODES: MX2007M
MX2007L
MX2007XL



**DISPOSABLE SUIT
TYPE 5/6 SUIT
NON TAPED**
CODE:
MX2007 - XLARGE
MX2007M - MEDIUM



DIGITAL THERMOMETER
CODE: MX2001



DISINFECT 20L
CODE: MXD20L



SPRAY SANITISER
CODE: (65ML) MXD65
(500ML) MXD500



5LTR HAND SANITISER
CODE: C210



HAND GEL 70% ALCOHOL
CODE: MXD100ml



SURGICAL MASK 3PLY

CODE: MX2005C



**BUY
2000PCS
€ .30**

SURGICAL MASK 3PLY

CODE: MX2005C



FOLD FLAT BOX OF 50PCS

CODE: MX2005B K95



FOLD FLAT PREPACKED

CODE: SE1242D 2PC K95 MASK

FFP2



CUP MASK

CODE: MX2005 FFP2

FFP2



2PC FFP2 MOULDED PREPACKED MASK

CODE: SE1242C

INDUSTRIAL WIPES

100
PCS

INDUSTRIAL WIPES

WIPES



SAFELINE

STOP THE SPREAD OF VIRUSES & GERMS



STOP THE SPREAD OF VIRUSES & GERMS



BACTERICIDAL
EN1276

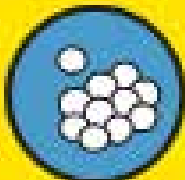

FUNGICIDAL
EN13727



VIRUCIDAL
EN14476

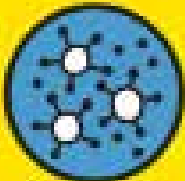

MYCOBCTERICIDAL
EN14476

Will also Clean Tough Stains such as:

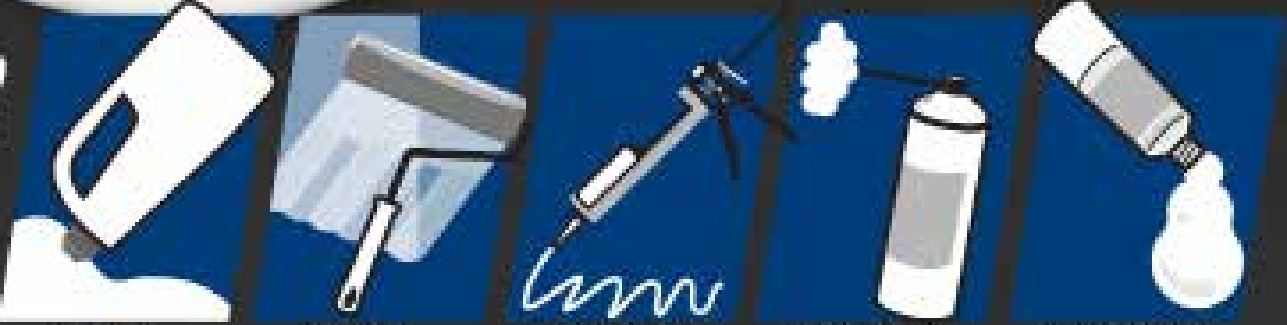

Grease & Oil

Paint & Epoxies

Silicones & Sealant

Expanding Foam

Adhesives & More

CODE: WIPESABC

1LTR DISINFECTANT SPRAY

FOOD SAFE DISINFECTANT



- ✓ **KILLS 99.9% OF BACTERIA FAST**
- ✓ **SANITISES SURFACE IN 30 SECONDS**
- ✓ **NON-TAINING & FOODSAFE**
- ✓ **FRAGRANCE FREE**

Coronavirus Indoor and Outdoor Print Services

1. Small Sanitizing Station



Size: 1800mm
X 1000mm x 400mm

2. Dividers

Screen Dividers



Size: 1860mm H
X 675mm W

Hand Dividers



Size: 1860mm H
X 675mm W

3. A Boards



Size: 565mm W
X 855mm H



Size: 565mm W
X 855mm H

4. Pull Up Banner



Size: 850mm W
X 2600mm H



Size: 850mm W
X 2600mm H

Coronavirus Indoor and Outdoor Print Services

5. Floor Graphic



Size: 600mm X 80mm



Size: 300mm DIA



Size: 600mm X 80mm

6. Sanitiser Info Card



Size: A3

7. Info Poster



Size: A4



Size: A4



CLIMAX PRO GOGGLE

The AZAHARA GOGGLES has been designed to protect against mechanical risks, chemicals, dust and drops or mists of liquid. It offers a wide field of view thanks to its wrap-around design. The frame is made of vinyl material and its design allows it to be used with most of the user's own prescription glasses. The polycarbonate eyepiece offers excellent protection against mechanical risks. The polycarbonate eyepiece offers excellent protection against mechanical hazards. The support band is adjustable to suit the different morphology of users. Weight: 0.107 kg.

CODE: CLX2001



CLIMAX GOGGLE INDIRECT

Designed to offer effective protection against the impact of high speed and low energy particles, against liquid drops or splashes, coarse dust particles, gas and fine dust particles. Optical class 1. Treatment: Anti-fog + anti-scratch. Ventilated*

CODE: CLX2002



CLIMAX RUBBER MASK INCL P3 FILTER

Main body of the half mask: The main body of the half mask is made from thermoplastic rubber. The design and the material used allow it to adjust to the face in an airtight manner, preventing air from leaking into the interior through the face/mask join. The main body houses the filter connector and two exhaling valves. Exhaling valves: The half mask is fitted with two exhaling valves made up of a valve-holder and a membrane, which makes it easier for exhaled air to escape. Fastening harness: It has a comfortable neck strap and head strap that can be easily adjusted to the right length. Filters The filters are secured to the half mask with a thread system Weight: 0,170 Kg.

CODE: CLX2004



CLIMAX 2.5M FALL BLOCK ARRESTER

It is a device with an automatic inertia braking system in case of a fall. These devices, once secured to a safe anchoring point, enable the user to work with the maximum mobility, safety and comfort on slopes, roofs, coned spaces. The retractable lifeline device model Climax 2.5 M consists of:

- 2 x Hook Climax 30: Symmetrical connector with a manual threaded locking. 16mm opening. Used for anchoring or to connection structures.
- Cover made in ABS.
- Fitted with energy absorber. It is stopped with a force of less than 6kN.
- 49 mm wide lanyard. Length: 2.5m.
- Working load: 100 kg.
- Weight: 1.075 kg

CODE: CLX2013



CLIMAX FACE SHIELD

Browguard The semi-circular browguard is manufactured of black polyethylene and includes a narrow brim. The visor is attached to the browguard by means of two centre pins and two turn fasteners on the sides. The browguard also contains a slot on each side in order to hold a bolt-nut system used to attach the browguard and headgear. Headgear The headgear system is composed of a harness and adjustment system, manufactured of injection-moulded black polyamide. The harness comprises two parts, an upper cross strap and a contour strap. The length of the cross strap can be adjusted by means of the holes and anchor stud system. The contour strap has a middle section (which rests on the wearer's forehead) and side arms that join at the rear of the head by means of the adjustment system. This system, which has a closing tube, guide and wing nut, allows easy adjustment of the contour band circumference by simply pressing and simultaneously turning the wing nut. For greater comfort, the contour strap has two self-sticking foams on the front of the strap where it rests on the wearer's forehead. Visor The visor is manufactured of 1.15-mm thick clear polycarbonate. Optical class: 2 Visor size: 190 x 324 mm Harness size: 56 - 64 cm Weight: 0,262 kg

CODE: CLX2003



CLIMAX P3 FILTER SINGLE

Filter P3 against particles made up of a high-density polyethylene black base fitted with a round cover made up with the same material. Between the cover and the base there is a pre filter with a high absorption capacity against particles. Thread connection system. Grinding, cutting, drilling of wood, stainless steel, paint, lacquer and corrosion, resistant paint. Varnishing with solvent-based paint, asbestos removal. Protection against bacteria and viruses. R mark: Reusable filter

CODE: CLX2005



CLIMAX HARNESS BASIC

Includes a dorsal fall arrest attachment point (A) comprising with a 8mm steel D buckle (No.1) and a chest fall arrest attachment point composed of two straps. (No.2) 45 mm polyester strap. Includes buckles on the leg loops. The lifetime estimated of this product is 10 years and 5 years after the first use, Fall arrest (EN 361:2002 CE)

CODE: CLX2006



CLIMAX 4 POINTS HARNESS MAXIPRO

The harness includes two anti fall anchoring points: dorsal (A) with a 8mm D buckle (No.1) and chest fall arrest attachment point (No.2) composed of two straps (A/2). The work positioning belt (No.3) allows the user to safely and securely anchor himself to the structure on which he is working to achieve full fall protection. The belt is made of polyester strap with a width of 45 mm. The waist belt contains the D-rings used to secure the user to the anchoring point. Weight: 1,47kg. Maximum weight: 100kg.

CODE: CLX2007



1. CLIMAX FALL ABSORBER 1.6

This energy absorber is made up of an absorption strap and a fastening strap. The absorption strap is a white strap made up of two pieces of interwoven fabric, which are folded and are contained in a transparent plastic cover. The ring and fastening strap is an orange polyester strip with sewn loops at the ends. The loops are protected by a plastic transparent cover. Protection against static electricity. To use in a potentially explosive atmospheres (ATEX). The lifetime estimated of this product is 10 years and 5 years after the first use. Total length: 1'6m. The energy absorber mod. 31-A is also available with 2 connectors mod. Climax 30 (energy absorber mod. 31-A 30/30).

CODE: CLX2008

2. CLIMAX FALL ABSORBER LANYARD 35CM

This energy absorber is made up of an absorption strap and a ring and fastening strap. The absorption strap is a white strap made up of two pieces of interwoven fabric, which are folded and are contained in a transparent plastic cover. The ring and fastening strap is an orange polyester strip with sewn loops at the ends. The loops are protected by a plastic transparent cover. Protection against static electricity. To use in a potentially explosive atmospheres (ATEX). The lifetime estimated of this product is 10 years and 5 years after the first use. Total length: 1'6m.

CODE: CLX2010

3. CLIMAX 2M WEBBING LANYARD

Have Comfortable Elastic Webbing Lanyard that comes with automatic hooks or with snap and scaffold hook. Includes: Securing strap: made of woven synthetic fibre of 40mm nominal width. With a tubular construction and incorporating an elastic inside to avoid undesired stretching of the strap. Energy absorber: Energy absorption strap. 1 connector mod. 32: Steel directional connector. Automatic threaded locking system. Used for anchoring or to connect in structures. MBL: 22 kN. 18mm opening. 1 connector mod. 31: Directional steel connector with an automatic jocking system. Appropriate for connection to large diameter structures. MBL: 22kN. 54 mm opening. The lifetime estimated of this product is 10 years and 5 years after the first use. Total length: 1'50m. Weight: 1,110 kg

CODE: CLX2009



CLIMAX HOOK CONNECTOR OPEN 54CM

The connector Climax 31 is a component of a safe fall protection or restraining system. The connector is designed to connect the various components of a fall protection or restraining system and to connect the entire system to the anchorage point on the structure where the user is working. The connector mod. 31 is an essential part of a failsafe fall prevention or fastening system. The snap ring is designed to be used as a connection between the fall prevention system and the anchoring point on the work structure. All connector components are made of steel with

CODE: CLX2012



CLIMAX CONNECTOR GATE OPEN 16CM

The connector Climax 30 is an essential component of a safe fall protection or restraining system. The connector is designed to connect the various components of a fall protection or restraining system and to connect the entire system to the anchorage point on the structure where the user is working. CE Test / CE EN362:2004 Exigencias de salud y seguridad del R. D.1407/1992 Organismo de control N° 0159 CE Certification Norms: EN 362:2004 Health and safety requirements of R.D.1407/1992 Control body number: No. 0159 The Climax 30 karabiner is connector with an automatic spring-loaded closure and manual locking barrel. This closure system prevents involuntary or accidental opening of the connector. All connector components (body, pins, spring, barrel, screwgates and locking mechanism) are made of steel with excellent mechanical properties. To use in a potentially explosive atmospheres (ATEX) MBL: 22kN Opening: 16 mm. Weight: 175 g.

CODE: CLX2011

UNIVERSAL HELMET VISOR

5.18

FITS ANY HELMET

COVID19 SITE RESTRICTIONS AID

CODE:MX2004D

FOR ONLY



REINFORCED SHATTERPROOF
SCREEN WITH ALUMINIUM
EDGE FOR EXTRA STRENGTH



TILT ANGLE 90 DEGREES



SPRING LOADED RUBBER
STRAP FITS ALL HELMETS



ABS FRAME WITH EXTRA
STRONG HINGE

LED BEANIE



USB CHARGING



Fishing



Night Walking



Hiking



Cycling



BBQ



Backpacking



Camping

BUY 10 GET 1 FREE

NEW

SAFETY

STANDARD BEANIE



BUY 10 GET 1 FREE



NYLON RAIN SUIT

Two piece nylon/pvc rainsuit. Fully taped seams, foldaway hood, vented back, zip front, two pockets, Trousers with elasticated waist, Individually packed in hanging bag. Available in Sizes: **SMALL - XXL**

CODE: CL8412 , 13, 14, 15, 16

SAFETY

SAFETY

Trousers with elasticated waist, Individually packed in hanging bag.

Available in Sizes: **SMALL - XXL**

CODE: CL8419 , 20, 21, 22, 23



PU RAIN WEAR

FLEXOTANE RAIN TROUSERS

CODE	SIZE	PER PAIR
CL8435	SMALL	
CL8431	MED	
CL8432	LARGE	
CL8433	X LARGE	
CL8434	XX LARGE	



FLEXOTANE RAIN JACKET

CODE	SIZE	PER JKT
CL8440	SMALL	
CL8436	MED	
CL8437	LARGE	
CL8438	X LARGE	
CL8439	XX LARGE	

FLEXOTANE RAINSUIT

CODE	SIZE	PER SET
CLPB005M	Medium	
CLPB005L	Large	
CLPB005XL	X Large	
CLPB005XXL	XX Large	



SAFETY

SAFETY

SAFELINE

50
PIECES

24
cm

GRIP FLEX



CODE CL8008: MEDIUM 8

CODE CL8009: LARGE 9

CODE CL8010: XLARGE 10

PPE REGULATION 2016/425 CAT III TYPE B

CHEMICAL	MEAN DEGRADATION / %
40% SODIUM HYDROXIDE (CAS: 1310-73-2)	10.0
30% HYDROGEN PEROXIDE (CAS: 7722-84-1)	36.5
37% FORMALDEHYDE (CAS: 50-00-0)	17.5

TESTING REQUIRED:

• EN ISO 374-4:2019, PROTECTIVE GLOVES AGAINST DANGEROUS CHEMICALS AND MICRO-ORGANISMS, PART 4: DETERMINATION OF RESISTANCE TO DEGRADATION BY CHEMICALS



CE 2777

SAFETY



Code: CL7015 (11")

Code: CL7016 (14")

Code: CL7017 (18")

FULLY COATED TEXTURED PVC GAUNTLETS have open cuffs and provide excellent protection against chemicals, abrasions, cuts and snags, punctures, grease and oil. PVC coated gloves have no exposed stitching in the working area making them less likely to split at the seam, due to the interlock jersey liner. They are a cost effective option for chemical, construction, fishing, mining, oil and gas drilling,

PK QTY : 12

Code: CL7018

PVC COATED GLOVES WITH KNITTED WRIST

provide excellent protection against chemicals, abrasions, cuts and snags, punctures, grease and oil. PVC coated gloves have no exposed stitching in the working area making them less likely to split at the seam, the interlock knitted liner is moisture absorption.

PK QTY : 12



Code: CL7033

RED COW SPLIT LEATHER WELDING GLOVES, full palm. *
2-PC red cow split leather back

PK QTY : 12

SAFETY

SAFETY



Code: CL7010

**CANADIAN STYLE RIGGER
GLOVE**

made from leather.

PK QTY : 12

SAFETY

SAFETY

Code: CL7013

GRAIN FURNITURE HIDE.

*Safety Cuff with Vein Protection
Patch.*

Elasticated Back.

PK QTY : 12



LATEX DISPOSABLE GLOVES

SAFELINE **U** GLOVES



POWDERED
Available in **LARGE** Size only

DISPOSABLE SHOE COVERS



PER BAG OR

WHEN YOU BUY A CARTON
CARTON = 40 BAGS

SAFETY

SAFETY

SAFETY



ISO Cut **C**

REF: **G/HANTEX-INF-C5**

Hantex[®] INF-C5

CODES:

CL7099ZL - LARGE

CL7099ZXL - XLARGE

INF-C5

Special Non-porous nitrile foam coated, ISO Cut C glove with proprietary impact protection on the back of the glove. This glove offers cost effective protection to impact whilst retaining dexterity, longevity and comfort. Flexible green colour coded cut C liner ensures quick recognition of the cut hazard. Hardwearing nitrile foam palm coating offers excellent grip in wet and dry applications. Foam bubbles on the rear of the glove are placed to reduce any discomfort for the user during extended periods.

ADDED FEATURES

Individual Polybag

Multilingual UI

Typical Applications

Handling objects with sharp edges Construction
Automotive Engineering

Packing:

Per Case: 50 pairs

Per Pack: 5 pairs bulk polybag, 1 pair polybag

Standards and Pictograms:



EN388:2016



EN388:2016
Blade Cut TDM
ISO 13997

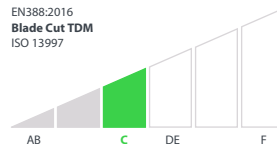

4 X 4 3 CP

Cut (0-5)

ENISO 13997 (A-F)
Impact Resistance





SUPER THERMAL GLOVE

CL7064 LARGE
CTN QTY:120

CL7065 XLARGE
CTN QTY:120



SAFETY

SAFETY



MIG WELDERS GLOVE

CL7030
PK QTY: 12

Wing thumb for durability and convenient handhold

- 35cm long
- Outer shell is made of BC grade split cowhide leather
- With cotton twill lining

STANDARD GREEN WELDERS GAUNTLET

CL7029
PK QTY: 12

A high quality traditional green welders gauntlet A cotton lining to the cuff with a soft comfortable fleecy lining to the glove area.

Applications: Welding, Grinding, Moderate Heat Protection and protection from small splashes of hot metal.





GREEN GRIP GLOVE POLY BAGGED

CL7006 LARGE 9
CL7007 XLARGE 10
PK QTY: 12
CTN: 120



CARRIAGE IS EXTRA AT €6.00PER CARTON

DESCRIPTION

• Coated palm • Elasticated cuff • Rough finish over entire surface • Anatomical shape • Seamless knit

RECOMMENDED FOR THESE RISKS:

• Cold • Tears • Micro-cuts

RECOMMENDED FOR THESE LINES OF WORK:

• Construction / Public Works
• Construction / Exterior Work



SAFETY

SAFETY



THERMAL GRIP

CL7076A 9LARGE
CL7076B 10XLARGE

- PALM COATED
- FLEECE LINED
- CONTROLLED GRIP
- CLASS LEADING

EN388:2016



2242X



AQUA TEC GLOVE WINTER WARM

CL8001A 9LARGE
CL8001B 10XLARGE
BUNDLES OF 12

- 100% WATERPROOF
- THERMAL

EN388



EN2242XX



SAFETY

SAFETY



SUPER FLEX GLOVES

FEATURE

These Superflex Safety Gloves feature a breathable coating which reduces heat, keeping hands cool and dry. Polyurethane/Nitrile micro foam coated on the palm, Seamless Nylon/Lycra Liner, Ultra thin coating for superior flexibility and dexterity, 10 pairs to a pack

INDUSTRIES

- Aerospace
- Automotive
- Manufacturing
- Warehousing & distribution

CL7073E MEDIUM 8 CTN QTY 120

CL7074E LARGE 9 CTN QTY 120

CL7075E X-LARGE 10 CTN QTY 120

SUPER GRIP GLOVES

CL7074C LARGE 9 CTN QTY 120

CL7075C X-LARGE 10 CTN QTY 120

VIZ FLEX GLOVES

CL7074R LARGE 9 CTN QTY 120

CL7075R X-LARGE 10 CTN QTY 120



SAFETY

SAFETY



CUT 5 GLOVE

Seamless glove. Materials. 13 gauge Cut 5 liner. PU Palm coating Suitable for use when handling sharp - edged items such as glass & metal.

Applications

- Construction
- Councils
- DIY
- General Handling
- Handling Sharp Objects
- Household Utility
- Janitorial
- Landscape Gardener
- Leisure
- Litter Collection
- Local Authorities
- Refuse Sorting

Safety Standards

- EN388 4543

Features

- Handling Sharp Objects
- Engineered full foam aerated latex coating, extra grip coating on palm
- 13 gauge liner
- Anatomical hand shape design
- Seamless knit



CL7099 LARGE
CL7099 XLARGE

AQUA GRIP WATERPROOF

Aqua Grip is a double latex fully coated glove, constructed on a 13-gauge nylon liner. Aqua grip is 100% waterproof keeping the user's hands dry and comfortable. It is our preference in terms of grip and flexibility in wet environments. It guarantees comfort and grip while maintaining an excellent level of flexibility.

KEY FEATURES

Ultra-flexible latex coating with superior grip on the palm for improved comfort and protection in wet conditions.

Water-repellent coating with a natural fit, for continuous comfort over long periods of use
Great grip performance for safe and precise handling in wet environments

Cushioned on the palm, offering the wearer improved comfort and protection



100% WATER PROOF
CL7074B LARGE
CL7075B XLARGE



BLACK/ FLOURESCENCE YELLOW GRIP GLOVE

CL7066 LARGE
CL7067 XLARGE
BUNDLES OF 12

THERMAL ORANGE/ BLACK GRIP GLOVE

CL7068 LARGE
CL7069 XLARGE
BUNDLES OF 12



SAFETY

SAFETY

SKYTEC ARIA GLOVES

CL7073	MEDIUM 8	CTN QTY 120
CL7074	LARGE 9	CTN QTY 120
CL7075	X-LARGE 10	CTN QTY 120

FEATURE

- Seamless nylon/spandex liner
- Anatomically engineered for maximum fit, superior comfort and dexterity
- 3D MOISTUREVAP - Total Breathability, Total Comfort, Total Performance

INDUSTRIES

- Aerospace
- Automotive
- Manufacturing
- Warehousing & distribution



SAFETY

SAFETY



SHOWA 310 GLOVE AVAILABLE IN BLACK & GREEN

CL7023 MEDIUM 8
CL7024 LARGE 9
CL7025 XLARGE 10
QTY: 120

CL7056 LARGE 9
CL7057 XLARGE 10

For intense manual handling, latex coated palm, excellent grip, ventilated, protects from micro-cuts

CHARACTERISTICS

- Coated palm
- Elasticated cuff
- Rough finish over entire surface
- Antibacterial and anti-odour treatment
- Anatomical shape
- Seamless knit

SHOWA THERMAL 451 GLOVE

451D LARGE 9

For intense manual handling in cold conditions, latex coated palm, excellent grip, ventilated, EN 511

CHARACTERISTICS

- Coated palm
- Elasticated cuff
- Rough finish over entire surface
- Antibacterial and anti-odour treatment
- Anatomical shape
- Seamless knit

SMARTGUARD THERMAL BUILDERS GRIP GLOVE

CL7053 LARGE 9
CL7054 XLARGE 10

GREY WINTER BUILDERS GRIP GLOVES

Special liner keeps hands warm in cold conditions Rubber coating provides excellent wet and dry grip
Available in sizes large and XL
Individually bagged
Suitable for use in construction, warehousing shipping/receiving and freezer/cold store work up to EN77, EN511 standards.



SAFETY

SAFETY



SHOWA 377 NITRILE FOAM GRIP GLOVE

CL7088 MEDIUM 8
CL7089 LARGE 9
CL7090 XLARGE 10
QTY: 120



Featuring a liquid proof nitrile undercoat for oil protection and an additional foam nitrile coating on top for excellent grip in wet and oily applications

CHARACTERISTICS

- Fully coated, extra coating on palm
- Reinforced knit cuff, scalloped edge
- Standard finish
- Without special treatment
- Anatomical shape
- Seamless knit

SHOWA 376R NITRILE FOAM GRIP GLOVE

CL7091 MEDIUM 8
CL7092 LARGE 9
CL7093 XLARGE 10
QTY: 120

Nitrile coated and 3/4 nitrile sponge palm, great dexterity and good tear resistancy

CHARACTERISTICS

- Fully coated, extra coating on palm
- Reinforced knit cuff, scalloped edge
- Standard finish
- Without special treatment
- Anatomical shape



SAFETY

SAFETY



SKYTEC ARGON GLOVES

CL7085 MEDIUM 8

CL7086 LARGE 9

CL7087 XLARGE 10

QTY: 120



OEKO-TEX 100 CERTIFIED, 3D MOISTUREVAP, EXCELLENT GRIP FEATURES

- Seamless nylon/spandex liner
- Anatomically engineered for maximum fit, superior comfort and dexterity
- 3D MOISTUREVAP - Total Breathability, Total Comfort, Total Performance
- Excellent grip in both wet and dry environments
- Enhanced lifecycle through increased resistance to abrasion and tearing
- Tested for harmful substances according to Oeko-Tex® Standard 100

CHARACTERISTICS

- Seamless nylon/spandex liner
- Patented NFT™ nitrile foam palm coating enhances protection
- Treated with Actifresh to kill bacteria and promote freshness
- Grey and black aesthetics for extended use

INDUSTRIES

- Aerospace •Automotive •Manufacturing •Warehousing & distribution

SAFETY

SAFETY



SHOWA SPRAYMASTER GLOVE

CL7094 MEDIUM 8

CL7095 LARGE 9

QTY: 120

100% NITRILE GAUNTLET

Protects hands against most common pesticides, herbicides and weed killers

Water resistant

LATEX-FREE

Reduces chances of allergic reaction

FLOCK-LINED

Ultra comfortable

SHOWA 12" 660 OIL RESISTANT GLOVE

CL7000 MEDIUM 8

CL7001 LARGE 9

CL7002 XLARGE 10

QTY: 120

CHEMICAL RESISTANT, ULTRA COMFORTABLE WITH GOOD MECHANICAL RESISTANCE

CHARACTERISTICS

- Fully coated, extra coating over entire hand
- Scalloped edge
- Rough finish over entire surface
- Antibacterial and anti-odour treatment
- Special hydrocarbon treatment
- Anatomical shape
- Seamless knit



SAFETY

SAFETY

FISH SCALE GLOVES



SAFETY

SAFETY



GRIPSTER GLOVE(ORANGE BOX)

CODE	DESCRIPTION	PRICE PER GLOVE (50PR PER PACK)
CL7077	LARGE	
CL7078	X LARGE	

SAFELINE KODA BOOT BLACK S3 W/P METAL FREE

OUR LIGHTEST SHOE YET
ONLY 680 GRAMS



BLACK
KODABK06 - KODABK12



BROWN
KODABR06 - KODABR12

SAFELINE HURRICANE SIP SRC METAL FREE

OUR LIGHTEST SHOE YET
ONLY 440 GRAMS



 COMPOSITE TOE CAP

SCUFF CAP

GEL SOLE

 SLIP RESISTANT

UPPER HIGH GRADE MESH

 ANTI PENETRATION KEVLAR SOLE

EVA RUBBER SOLE

BLACK

HURRICANE 06 - HURRICANE 12



NEW!

SAFELINE

WATERPROOF BOOT

WPB39-WPB47

KEY FEATURE

- Waterproof Upper
- Steel toecap and protective midsole
- Leather upper with padded collar
- Hard-wearing PU sole
- Slip-resistant sole rated at the highest level
- Fully moulded and removable insole
- Wide fitting

**SAFETY RATING EN20345 S3 WR SRC
WPB39-47**

SAFETY

SAFETY



DEALER BOOT

BROWN CODE DBR (+SIZE) EG: DBR43
BLACK CODE DBK (+ SIZE) EG: DBK43



*Lightweight sole, with
steel toe-cap, and steel
midsole*

*Footwear Sizes 6 to 12
Colours BLACK OR
BROWN*

SAFETY

SAFETY



PANDA BOOT AND SHOES (SIP)

CODE SHOE: B6219 + SIZE
CODE SHOE: B6919 + SIZE

*Professional safety boots with steel toe cap,
sole resistant to fuels, antistatic.
safety footwear, closed seat region, antistatic,
energy absorbancy in heel region
SIZES AVAILABLE: 6 -13*



SAFETY

SAFETY



WELLINGTON BOOT S5 STEEL TOE AND MIDSOLE OR SOFT TOE

CODE: STEEL TOE: WBR + SIZE

- SLIP RESISTANT
- VERY COMFORTABLE
- MEETS EUROPEAN REQUIREMENTS
- GUARANTEED 100% WATERPROOF
- COLD INSULATING
- STEEL TOE CAP & MID SOLE IN OUR WBST RANGE & MID SOLE
- ANTI STATIC

CODE: SOFT TOE: WBST + SIZE

SIZES AVAILABLE: 6 -13



SAFETY

SAFETY

GEOS S3

SAFETY JOGGER **SAFETY SHOES**



SIZES: 40-47

CODE: GEOS40

SAFETY

SAFETY

DAKAR BLACK S3 (METAL)



SIZES: 40-47

CODE: DAKARBK40



FREE PAIR OF SOCKS
WITH EVERY PAIR
ORDERED ON FIRST ONLY

SAFETY JOGGER
SAFETY SHOES



SIZES: 40-47

CODE: DAKARBR40

SAFETY

SAFETY

DESERT
BLACK
SIP (METAL)



SIZES: 40-47

CODE: DESERTBK40



FREE PAIR OF SOCKS
WITH EVERY PAIR,
ORDERED ON FIRST ONLY

DESERT HONEY SIP (METAL)

SAFETY JOGGER SAFETY SHOES



SIZES: 40-47 CODE: DESERTHON40



FREE PAIR OF SOCKS WITH EVERY PAIR ORDERED ON FIRST ONLY

FREE STAND



SAFETY

SAFETY



RIGGER BOOT (SIP)

CODE FOR BROWN: B80741 + SIZE

CODE FOR BLACK: B80751 + SIZE



- *TYPE: SIP*
 - *ANTISTATIC*
 - *OIL RESISTANT SOLE*
 - *ANKLE PADDING*
 - *PROTECTION TONGUE*
 - *CONFORMS TO CEE STANDARD ETC.*
 - *AVAILABLE IN BLACK AND BROWN*
- SIZES AVAILABLE: 6 -12*

SAFETY

SAFETY



PANDA BOOT / SHOE BLACK STEEL TOE (S1)

PANDA BOOT S1		
CODE	SIZE	PRICE
S139	6	
S140	6 1/2	
S141	7	
S145	10	
S147	12	
S148	13	

PANDA SHOE S1		
CODE	SIZE	PRICE
SS421939	6	
SS421942	8	
SS421943	9	
SS421944	9 1/2	
SS421947	12	
SS421948	13	

PANDA BOOTS BLACK (STEEL TOE & MID SOLE) SIP

PANDA BOOT SIP		
CODE	SIZE	PRICE
SIP36	3	
SIP37	4	
SIP38	5	
SIP39	6	
SIP40	6 1/2	
SIP41	7	

PANDA BOOT SIP		
CODE	SIZE	PRICE
SIP42	8	
SIP43	9	
SIP44	9 1/2	
SIP45	10	
SIP46	11	
SIP47	12	
SIP48	13	



SAFETY

APACHE WORK BOOTS

CODE: APACHE314CM-SIZE

Sizes available: 6 - 12

FEATURE LIST

- Steel Toe Cap S3
- Composite Mid-sole
- Rubber Sole
- Water Resistant Nu-buck Uppers
- Deep Padded Collar
- Padded Tongue
- Comfort Foot Bed In-soles

Product Description

Apache light weight flexible water resistant Nu-buck safety hiker



SAFETY

SAFETY

APACHE S3 BROWN WAXY BOOT

CODE: APACHE315CM-SIZE

Sizes available: 6 - 12

FEATURE LIST

- Steel Toe Cap S3
- Composite Mid-sole
- Rubber Sole
- Water Resistant Nu-buck Uppers
- Deep Padded Collar
- Padded Tongue
- Comfort Foot Bed In-soles

Product Description

Apache light weight flexible water resistant Nu-buck safety hiker

NEW!

PROFESSIONAL EAR DEFENDER

SE1310PRO



SAFETY

SAFETY

EAR DEFENDER



SE1310
Bx Qty: 12



EAR PLUGS

PU Foam SoundStopper™ EarPlugs (SNR 33)



EAR PLUGS (BX 250)	
CODE:SE1048	
<p>A highly effective earplug offering excellent attenuation. Very economical, disposable and easy to use.</p> <p>Manufactured from a soft energy absorbing polymer foam which compresses and expands for the perfect custom fit of any ear canal</p>	

Earplugs PVC Corded Noise Level Reduction 36dB CC-01-000 Pack 200



CORDED EAR PLUGS (BX 200)	
CODE:SE1048C	
<p>Made from soft energy absorbing polymer foam providing excellent hearing protection and all day comfort Humidity absorption-resistant helping to reduce moving and shifting problems when used in moist conditions Designed to fit and protect without irritation</p>	



EAR PLUGS (20 PCS)	
CODE: SE1048D	
<p>Slow rebound foam material conforms to various ear canal structures and exerts no pressure on the ear. Excellent for sleeping, working, studying, shooting, traveling, or any other situation where silence is required.</p>	

SAFETY

SAFETY



CODE: SE1074

Sonis® 1 Overmoulded Small Cup Ear Defender



CODE:SE1069

Sonis® 1 Helmet Mounted Ear Defender

FEATURES

THE SONIS® RANGE OF EAR DEFENDERS HAVE BEEN DESIGNED BY THE JSP R&D TEAM. WORKING WITH A LEADING UK ACOUSTIC ENGINEERING RESEARCH FACILITY THEY HAVE DEVELOPED AN EAR DEFENDER RANGE THAT PEAKS AT AN UNBEATEN 37 SNR.

FEATURES & BENEFITS

- SNR 27
- LOW ATTENUATION SMALL CUP 80-107 DB
- MODERATE INDUSTRIAL NOISE
- WORKSHOPS
- PRINTING WORKS
- LANDSCAPING
- LEISURE ACTIVITIES
- HYGIENIC
- CUSTOMISATION
- COLOUR CODING FOR EASY SELECTION



SAFETY

SAFETY

GOGGLE/MASK COMBO FMP3V

CODE: SE1083

FILTERSPEC® PRO™

The unique patented FilterSpec® Pro™ effortlessly combines both eye & respiratory protection. The 5.5 base one piece polycarbonate lens offers optimal coverage and class 1 optics whilst ergonomically shaped soft goggle housing provides excellent levels of comfort and unbeatable levels of protection. Anti-Scratch coating as standard. FMP3V filtration giving 94% efficiency. FilterSpec® out exceeds EN1827 for breathing resistance by more than HALF and performs over 3% above the standard for filtration efficiency. Includes white holder, 3 filters and spectacle with Clear HC & Anti-Mist Lens.

FEATURES

GOGGLE

- Stylish goggle design providing impact protection.
- Fully adjustable dual wide fitting elastic harness for optimum fit & comfort.
- 5.5 base, one-piece lens offers optimal coverage.
- Anti-Mist Coating on Lens as standard.
- Anti-Scratch Coating on Lens as standard.
- Conforms to EN166 T.B.T 3.4.N

FILTER MASK

- Disposable filter mask element for optimum protection.
- Re-usable filter holder element for an economic PPE solution.
- Conforms to EN1827:1999+A1:2009
- Lightweight for user comfort. (Under 60g)
- Exhale valve fitted for increased filter element longevity.
- Each product comes supplied with 3 filter elements.
- Removable, replaceable elastic strapping.

SPECTACLE/MASK COMBO FMP3V

CODE: SE1084

FILTERSPEC®

The unique patented FilterSpec® effortlessly combines both eye & respiratory protection. The one-piece lens offers optimal coverage and has Anti-Mist and Anti-Scratch coating as standard. FMP3V filtration giving 94% efficiency. FilterSpec® out exceeds EN1827 for breathing resistance by more than HALF and performs over 3% above the standard for filtration efficiency. Includes white holder, 3 filters and spectacle with Clear HC & Anti-Mist Lens.

FEATURES

SPECTACLE

- Stylish spectacle element design.
- Fully adjustable spectacle frame for maximum comfort & security
- 6.5 base, one-piece lens offers optimal coverage.
- Anti-Mist Coating on Lens as standard.
- Anti-Scratch Coating on Lens as standard.
- Conforms to EN166.1.F
- Wide range of lens coatings available.
- Wide range of colour combinations available.

FILTER MASK

- Disposable filter mask element for optimum protection.
- Re-usable filter holder element for an economic PPE solution.
- Conforms to EN1827:1999+A1:2009
- Lightweight for user comfort. (Under 60g)
- Exhale valve fitted for increased filter element longevity.
- Each product comes supplied with 3 filter elements.
- Removable, replaceable elastic strapping.





FORCE 8 HALF MASK INCL P3 FILTERS

SE1087B

The Force8™ twin cartridge half mask with Typhoon™ valve offers superior low breathing resistance and a 4-point suspension harness with quick release buckles. The mask is made with a durable thermoplastic rubber offering a superior fit to most face shapes. The mask accepts the full range of low profile Force8™ filters giving the Force8™ the flexibility to be used for many applications, providing filtering protection against particulates, many gases and vapours.

C/W P3 filters x2
BHTOA3-OL5-N00



FORCE 8 HALF MASK - NO FILTER

SE1086

Force8™ Half Mask with Typhoon™ Valve without Twin Cartridges

The Force8™ twin cartridge half mask with Typhoon™ valve offers superior low breathing resistance and a 4-point suspension harness with quick release buckles. The mask is made with a durable thermoplastic rubber offering a superior fit to most face shapes. The mask accepts the full range of low profile Force8™ filters giving the Force8™ the flexibility to be used for many applications, providing filtering protection against particulates, many gases and vapours

BHT003-OL5-000



FORCE 8 HALF MASK C/W ABEK1P3 FORCE 8 FILTERS

SE1089

The Force™ 8 twin cartridge half mask with Typhoon™ valve offers superior low breathing resistance and a 4-point suspension harness with quick release buckles. The mask is made with a durable thermoplastic rubber offering a superior fit to most face shapes. The mask accepts the full range of low profile Force™ 8 filters giving the Force™ 8 the flexibility to be used for many applications, providing filtering protection against particulates, many gases and vapours.

BHTOC3-OL5-N00



FORCE 8 MASK C/W A2/P3 PRESS TO CHECK FILTERS

SE1085A

Organic gas vapour and construction dust replacement filters. Press-to-check filters facilitate instant and accurate checking of the face fit, without effecting the seal of the mask to the face. Allow air to flow across the full area of the filter material, increasing efficiency and extending life.

SAFETY

SAFETY



**FORCE 8 PK 2 A2P3 FILTERS
PRESS TO CHECK**

SE1085

Comfort
FIT IT!
Don the Mask - Put the straps and harness over your head and pull the straps to a suitably tight and comfortable fit.
PRESS IT!
PressToCheck™ - Press the front and backs of both filter covers together to stop air from entering through the filters.
CHECK IT!
Inhale - No air should come through the mask. Adjust the mask and repeat until it doesn't. Release when seal is made.
BMN740-000-600

SAFETY



**FORCE 8 P3 FILTERS ONLY
PRESS TO CHECK**

SE1086A

Comfort
FIT IT!
Don the Mask - Put the straps and harness over your head and pull the straps to a suitably tight and comfortable fit.
PRESS IT!
PressToCheck™ - Press the front and backs of both filter covers together to stop air from entering through the filters.
CHECK IT!
Inhale - No air should come through the mask. Adjust the mask and repeat until it doesn't. Release when seal is made.
BMN990-001-700

SAFETY



FORCE 8 A1 P2 FILTERS

SE1087

Cost effective filters for protection against particulates with low profile angle for minimum visual impairment. Cartridges have an integral maintenance free disposable inhalation valve. Easy to attach to the respirator with a secure fit when applied. P2 Dust protection filter is attached to the top of the A1 filter via a transparent clip on cover
BMP550-011-700



**FORCE 8 PK 2 ABEK1P3 FORCE 8
FILTERS**

SE1088

Comfort
FIT IT!
Don the Mask - Put the straps and harness over your head and pull the straps to a suitably tight and comfortable fit.
PRESS IT!
PressToCheck™ - Press the front and backs of both filter covers together to stop air from entering through the filters.
CHECK IT!
Inhale - No air should come through the mask. Adjust the mask and repeat until it doesn't. Release when seal is made.
BMN750-000-600

CARTRIDGES TO SUIT THE ABOVE RESPIRATOR

ABEK 1 PROTECTION FILTERS

CODE: SE1099

Olympus® Unifit Single Filter Cartridge ABEK1 These gas, vapour and dust filters are designed to fit the JSP range of Maxi and Midi masks. The full gas and particulate filter range is colour coded to European norms in EN141 and EN143.

BME 330-000-000



JSP A1 Tradesman 3

CODE: SE1093

Replacement Cartridges - Unifit™ A1 Organic Vapour Cartridge

BME200-000-000



Olympus® Unifit Filters B1 (Pack of 2)

CODE: SE1094

BME220-000-000



Olympus® Unifit Filters P2 (Pack of 2)

CODE: SE1097

BME380-000-000



JSP P3 Tradesman 3

CODE: SE1098

Replacement Cartridges - Unifit™ P3 Dust Cartridge

BME390-000-000



SAFETY

SAFETY



CODE: SE1070

STEALTH 8000 YELLOW SAFETY SPEC JSP

FEATURES

A LIGHTWEIGHT SAFETY SPECTACLE, WEIGHING JUST 26G, THE WRAPAROUND 9 BASE CURVE POLYCARBONATE LENS HAS A BUILT IN ADJUSTABLE PVC NOSE PIECE FOR ADDED COMFORT AND STABILITY. LOW PROFILE TENSION CONTROL TEMPLES PROVIDE EXTRA GRIP AND ARE SUITABLE FOR USE WITH HEARING PROTECTION. THE TEMPLE TIPS HAVE A SPECTACLE CORD ANCHOR POINT FOR FURTHER PRACTICALITY. UVA, UVB AND UVC PROTECTION. EN166 1.F.K

CODE: SE1071

EVO GOGGLE CLEAR JSP

FEATURES

EVO® GOGGLE - STANDARD SINGLE LENS ENGINEERED TO OFFER OUTSTANDING PERFORMANCE, COMPATIBILITY, COMFORT AND LOOKS. STANDARD SINGLE LENS GOGGLE FOR EVERYDAY PROTECTION.

LENS

ANTI-MIST & SCRATCH RESISTANT WITH UV PROTECTION

DESIGN

LOW PROFILE, LIGHTWEIGHT WITH SOFT EVA FOAM HOUSING FOR EXCEPTIONAL WEARER COMFORT PROTECTION

CODE: SE1068

VENUS DUST +LIQUID CLEAR GOGGLE JSP

FEATURES

THE VENUS™ INDIRECT VENTED GOGGLE IS A CLEAR POLYCARBONATE GOGGLE WITH A HARDIA™ ANTI-SCRATCH COATING. THE LENS AND BODY OFFER PROTECTION AGAINST MEDIUM ENERGY HIGH SPEED PARTICLES AT 120M/S (270 MPH) THE OPTICAL QUALITIES OF THE LENS COMPLY WITH REQUIREMENTS OF OPTICAL CLASS 1. THE BODY OFFERS PROTECTION AGAINST LARGE DUST PARTICLES AND LIQUID DROPLETS.

FEATURES & BENEFITS

- POLYCARBONATE LENS WITH HARDIA™ ANTI-SCRATCH COATING
- DUST AND LIQUID SPLASH PROTECTION
- INDIRECT VENTED, CLASS 1 OPTICS
- B GRADE IMPACT PROTECTION
- CONFORMS TO EN166 3.4.9.B AND 5 EN166 1.B



NEW!

PROFESSIONAL SAFETY GOGGLE

SE1112PRO



CHEMICAL + IMPACT GRINDING GOGGLE

SE1112

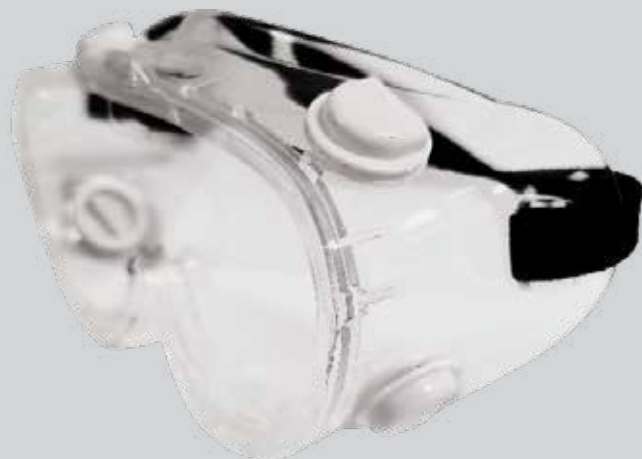

SAFETY

SAFETY

NEW!

STANDARD SAFETY SPECS CLEAR LENS

CODE1454

SE2158



SAFETY GLASSES VIPER BLUE CORDED

SE2159



CLEAR SAFETY SPECTACLES (OVER SPECS)

SE2160



SAFETY GLASSES NEVADA CLEAR CORDED

SE2161



SAFETY

SAFETY

NEW!

SAFETY GLASSES VORTEX BLACK CORDED

SE2609



SAFETY GLASSES SOLAR CLEAR CORDED

SE2610



SAFETY GLASSES MATRIX CLEAR CORDED

SE2623 **€4.14**



SAFETY

SAFETY

MESH VISOR FACE

CODE: SE3744P

FEATURES

- POLYPROPYLENE HEADGEAR
- POLYCARBONATE MESH VISOR (VISOR SIZE : 8" X 15 1/2")
- PROTECTS BOTH THE HEAD AND FACE AGAINST FLYING DEBRIS.
- PROTECTS AGAINST THE MED-INTENSITY IMPACT
- CE EN166. 1B.39 EN17312006



REPLACEMENT MESH FACE SHIELD

CODE: SE374FPP

PRICE: €5.21

CLEAR VISOR FACE

CODE: SE3740PP

FEATURES

- POLYPROPYLENE HEADGEAR
- ALUMINUM BOUND POLYCARBONATE MESH VISOR (VISOR SIZE: 8" X 15 1/2")
- PROTECTS BOTH HEAD AND FACE
- SUITABLE FOR HAZARDOUS SPLASHES, LIQUIDS, CHEMICALS, AND THE MOLTEN METAL, RADIANT HEAT AND OTHER DANGEROUS ITEMS.
- PROTECTS AGAINST THE MED-INTENSITY IMPACT
- CE EN166.1B.39 EN17312006



CODE: SE37C

PRICE: €6.48

REPLACEMENT CLEAR I

SAFELINE

**SAFELINE
STANDARD SAFETY HELMET**

- SE1050C YELLOW
- SE1051C BLUE
- SE1052C GREEN
- SE1053C WHITE
- SE1054C RED



SAFETY

SAFETY

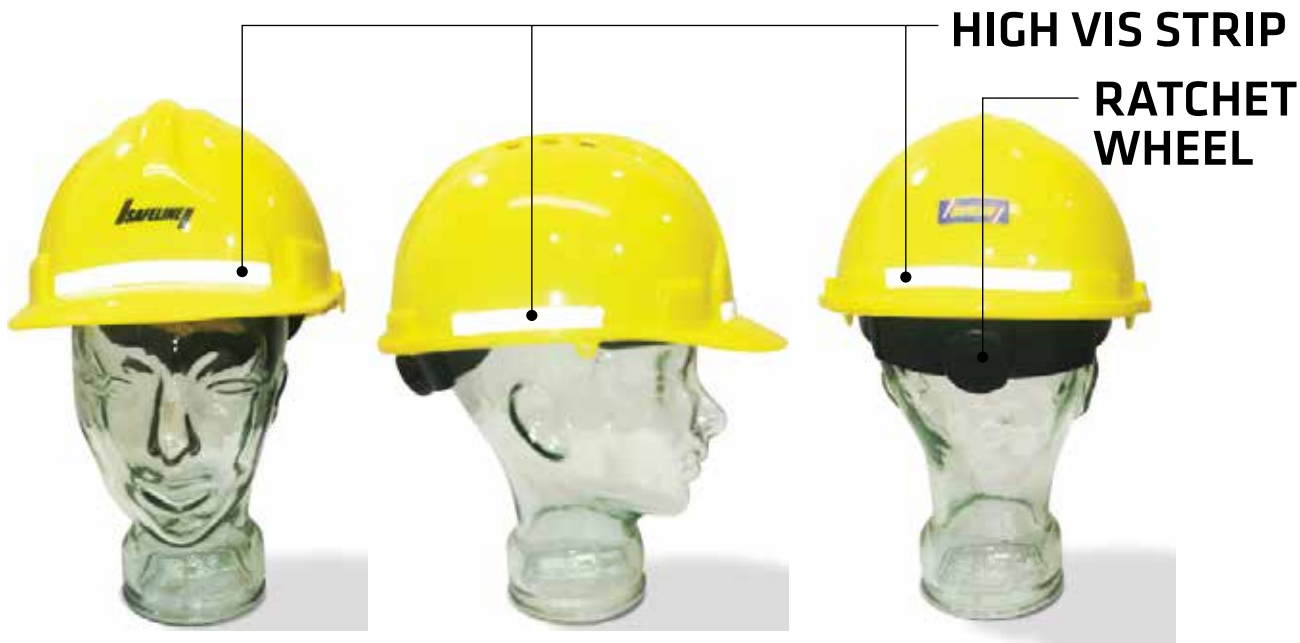

SAFETY HELMET COMFORT

- SE1056 YELLOW
- SE1057 BLUE
- SE1058 GREEN
- SE1059 WHITE
- SE1060 RED

- HELMET OFFERS 440V ELECTRICAL INSULATION
- FULLY ADJUSTABLE 8-POINT SUSPENSION HARNESS
- FULL COLOUR RANGE AVAILABLE
- INTERNATIONAL SLOT TO ACCEPT ACCESSORIES
- 530-630MM SIZING
- (61/2 - 77/8)
- FULLY ADJUSTABLE SLIP RATCHET HEADBAND



OXFORD, ENGLAND



SAFETY HELMET MARK 2

SE1050 YELLOW

SE1051 BLUE

SE1052 GREEN

SE1053 WHITE

SE1054 RED

- SHELL MANUFACTURED FROM UV STABILISED HIGH DENSITY POLYETHYLENE
- LIGHT AND COMFORTABLE TO WEAR HELMET OFFERS 440V ELECTRICAL INSULATION
- INTEGRAL RAIN CHANNEL FOR GREATER COMFORT IN POOR WEATHER
- SLIP RATCHET ADJUSTABLE HEADBAND
- CONFORMS TO EN 397,
- ANSI Z89

ELASTIC CHIN STRAP WITH CHIN CUP

CODE: SE1049

FEATURES

- WIDE ELASTIC CHINSTRAP RELEASES AUTOMATICALLY WITH FORCES BETWEEN 150 AND 250 NEWTONS.









CAUTION WET FLOOR SIGN
CODE: SS110
 Manufactured from yellow high impact polypropylene. Caution Wet Floor' logo.
Carrying Handle
Size 23.5cm/9¼" x 61.5cm/24¼"
Weight 0.85kg
Packed 10 per carton

SITE SAFETY NOTICE
Code: SS05
Size: 32" X 24"
PK SIZE 10

SITE SAFETY NOTICE

-  **Unauthorised entry to this site is strictly prohibited**
-  **WARNING CONSTRUCTION IN PROGRESS**
Parents are advised to warn children of the dangers of entering the construction sites
- 
 1. All visitors must report to the site office.
 2. Permission must be obtained before entering the site or any work area.
 3. Safety signs and procedures must be observed.
 4. Personal protection and safety equipment must be used at all times.
 5. All persons entering this site must comply with the regulations under the Health & Safety at Work Act 1974.
-  **Safety helmets must be worn**
-  **Protective footwear must be worn**

		
PROTECTIVE FOOTWEAR MUST BE WORN	HEAD PROTECTION MUST BE WORN	HIGH VISIBILITY CLOTHING MUST BE WORN IN THIS AREA
CODE: SS20 600 X 400	CODE: SS21 600 X 400	CODE: SS22 600 X 400
		
WEAR EAR PROTECTORS	EYE PROTECTION MUST BE WORN	
CODE: SS23 600 X 400	CODE: SS24 600 X 400	

SAFETY

SAFETY



WORKPLACE & STATUTORY KITS HSE COMPLIANT - STANDARD

BLUE DOT

Low risk ideal for small office, shops, homes, etc where there are only a few people present and the risk of an accident is low. The HSE Standard First Aid Kit is from our economy range comes complete with its own durable plastic first aid box. The kit will ensure that you are complaint with the standard HSE recommendations for low risk environment.

CODE	DESCRIPTION	PRICE
BHSE10	10 Person Kit	
BHSE20	20 Person Kit	
BHSE50	50 Person Kit	

WHAT'S IN THE FIRST AID KITS?

COMPONENT	DESCRIPTION	QUANTITY		
		10 Person	20 Person	50 Person
Safety Pins	A pack of 6	1	2	2
Triangular Bandages	Min of 20GSM non-woven material or cotton, not less than 90 cm x 90cm x 127cm	4	6	8
Eye Pad Sterile Dressing	Conforming bandage, min 5cm width and min 1.5m stretched length or elasticated looped bandage with an oval pad: not less than 7cm x 5cm	2	4	6
Medium Sterile Dressing	Conforming bandage: min 7.5cm width and min 2m stretched length, with an absorbant pad: not less then 12 cm x 12cm	6	9	19
Large Sterile Dressing	Conforming bandage: min 10cm width and min 2m stretched length, with an absorbant pad: not less then 18 cm x 18cm	2	3	4
Nitrile Disposable Gloves	Conforming to BS EN 455-1 and BS EN 455-2, large size (8-9)	1 pair	2 pairs	3 pairs
Saline Cleansing Wipes	Individually wrapped, sterile, min surface area of 80mm squared	6	10	20
Plasters	Washproof - Bag 20	1	2	3
Guidance Leaflet	Provides brief first aid guidelines	1	1	1



ECABSORBER LANYARD 2.0M DA-1

CODE: 031130

SHOCK ABSORBING LANYARDS

The shock absorbing lanyards approved by norm EN 355, will be used as elements or components, well integrated with a fall arrest lanyard, an anchor point or a fall arrest harness, or perhaps in combination with some of them.

A shock absorber is a component or an element of a fall arrest system designed to clear the kinetic energy developed during a fall from a determined height.

CHARACTERISTICS

The shock absorber ECOABSORBER is produced with high tenacity polyester yarn. Special made webbing (patented) that with its loss of shape or destruction, absorbs an important part of the developed energy during the fall.

ECABSORBER DA-1S LANYARD

CODE@ 031144

SHOCK ABSORBING LANYARDS

The shock absorbing lanyards approved by norm EN 355, will be used as elements or components, well integrated with a fall arrest lanyard, an anchor point or a fall arrest harness, or perhaps in combination with some of them.

A shock absorber is a component or an element of a fall arrest system designed to clear the kinetic energy developed during a fall from a determined height.

CHARACTERISTICS

The shock absorber ECOABSORBER is produced with high tenacity polyester yarn. Special made webbing (patented) that with its loss of shape or destruction, absorbs an important part of the developed energy during the fall.



SCAFFOLDING HOOK

CODE: 031177



This is an auto-locking directional connector with very large gate opening for connection to metal structures or to large-diameter cables and bars.

It has a gated connection point for attachment to different types of lanyards.

If the lanyard is damaged, the connector can thus be reused.

The double action opening is ideal for one-handed operation. Training is essential before use, to ensure safe use of this product.



KARASBINERS

CODE: 031178

for use with ponsa products

SAFETY

SAFETY



PONSA ECOSAFEX 4 FALL ARREST HARNESS AND WORK POSITIONING BELT WITH CASE

CODE: 27887

PRODUCT DESCRIPTION

EXCELLENT SPANISH QUALITY, MANUFACTURED IN POLYESTER ALLOWING LOW ABSORPTION OF MOISTURE, HIGH DURABILITY WITH MINIMAL WEIGHT. ERGONOMIC DESIGN OFFERING MAXIMUM COMFORT AND OPTIMUM WORK POSITIONING CONFORMS TO EN361 – EN358

PONSA ECOSAFEX 2 FULL BODY HARNESS WITH CASE

CODE: 27860

PRODUCT DESCRIPTION

EXCELLENT SPANISH QUALITY BASIC HARNESS WITH LEG ADJUSTMENTS. 1 LINE POINT DORSAL RING, USED WHEN WORKING AT A HEIGHT, CONSTRUCCION AND INDUSTRY IN GENERAL. CONFORMS TO EN361 - EN363



VERTEX RETRACTABLE WEBBING FALL ARRESTER

CODE: 031175

PRODUCT DESCRIPTION

2.25M RETRACTABLE WEBBING FALL ARRESTER. ROBUST PLASTIC HOUSING & INSTANT LOCK OFF, WITH 2 SCREW GATE KARABINERS. THIS PIECE OF FALL ARREST EQUIPMENT CONFORMS TO EN 362, 355, 360.



PONSA LANYARD 1.4M

CODE: 031108

PRODUCT DESCRIPTION

WEBBING LANYARD LT101 2m (4.0303) EN 354

work positioning lanyard 30mm wide with sewn loop at both ends



POLY COTTON BOILER SUITS

- Comfort fit elastic back waist
 - All stress points bartacked for added strength
 - Concealed front metal zip
 - External pen partition on left chest pocket
 - Easy access cell phone pocket
 - Side access vents
 - Two large hip pockets
 - Side cargo pocket
 - Ruler utility pocket
 - Two seat pockets
- Applications/Industries
General work wear.

SAFETY

SAFETY

STANDARD		
CODE	SIZE	PER 1
CL8010	36	
CL8011	38	
CL8012	40	
CL8013	42	
CL8019	54	
CL8020	56	
CL8021	58	

DELUXE		
CODE	SIZE	PER 1
CL8030	36	
CL8031	38	
CL8032	40	
CL8033	42	
CL8034	44	
CL8035	46	
CL8036	48	
CL8037	50	
CL8038	52	
CL8039	54	



High Visibility Safety Vest Double Band

High visibility safety vest with reflective tape. Constructed from 100% polyester knitted fabric for long-term durability. Velcro fastening. Available Colour(s):

Available in sizes: MED – XXXL

CODE: CL8466 , 7 , 8 , 9,

CODE: CL8560 , 1 , 2 , 3,

CODE: CL8470



We can add your company name and logo for a small charge ask our staff

Ensure that you and your branch staff are safe in the yard with high visibility vests branded in up to 4 colours with your company logo. Please speak to our sales team about quantities or mixed items.

All of our Hi Vis clothing is available for printing. Production time will be confirmed on receipt of order

LONG SLEEVE HIGH VISIBILITY SAFETY VEST WITH REFLECTIVE TAPE. AVAILABLE IN STANDARD AND EXECUTIVE.

Constructed from 100% polyester knitted fabric for long-term durability. Velcro fastening.



Long Sleeve High visibility safety vest with reflective tape

Hi-Vis polyester long sleeve vest with Velcro closure to EN471.

Size Available **M to XXL**

CODE: CL8476 , 7 , 8, CL8479

Long Sleeve High visibility safety vest with reflective tape

Large side pockets, phone and ID holder pockets. Complies to EN ISO 2 Class 2. Available in yellow only.

Size Available **M to XXL**

CODE: CL8476E , 7E , 8E, CL8479E (EXECUTIVE)



High Visibility Safety Coat From

Confirms to EN471 class 3 breathable pu coating
 outer/nylon knitted lining material parka
 lining: 100% nylon
 padding: 100% polyester 180grams
 Available Colour(s): 

Available in sizes: SML – XXXXXL

CODE: CL8449, 50 , 51, 52, 53, 54 ,55 ,56 YELLOW

CODE: CL8570, 71 , 72 ORANGE (M-XL)



High Visibility Safety Trousers

Confirms to EN471 class 3 breathable pu coating
 outer/nylon
 Available Colour(s): 

Available in sizes: MED – XXL

CODE: CL8550, 51 ,52, 53

Hi-Vis Two Tone Fleece Jacket

Conforms to EN471 Class 2
 Hi-Vis Yellow and Navy fleece with 2 reflective bands
 around body and arms
 Navy contrast helps disguise soiling around hem and
 cuff areas
 Full length zip front
 Comfort fit elasticated cuffs
 Fully elasticated hem
 2 lower welted pockets
 High neck comfort collar
 Ideal for embroidery

Size Available **M - XXL**

CODE: CLHVK10BM, L , XL & XXL



€18.13

SAFETY

SAFETY



€14.02

Hi-Visibility REVERSILBE BODYWARMER

Conforms to EN471 Class 2.
Polyester coated fabric with quilt lining, heavy duty zip.
Two pockets.
Fully reversible.
Two bands and braces.
Suitable for road works.

Size Available **M to XXL**

CODE: CL8472, 3, 4, 5

SAFETY

SAFETY

HIGH VISIBILITY SAFETY HOODED BOMBER JACKET

High-Vis Bomber Jacket c/w Mobile Phone Pocket on Outside & Inside.

Detailed Spec: Lined Waterproof Jacket, PU Coated Polyester, Reflective Tape Class 3, Fleece Lined Collar, Inset Hood, 2 Outer Front Pockets, 1 Inner Chest Pocket, Welded Seams for Permanent Resistance To Water, Zip and Popper Fastening.

Standard: EN471 Class 3

Available Colour(s): 

Size Available **SMALL - XXL**

YELLOW CODE: CLHV211S, M, L, XL, XXL

ORANGE CODE: CL8565, 6, 7, 8, 9



€18.99

APACHE WORK WEAR

ALL SEASON WORK JACKET



- PU coated nylon highly water repellent
- Micro fleece lined
- Storm flaps and taped seams, removable hood, reflective piping
- Internal phone pocket and document pocket

CODE	SIZE	COLOUR	PER SET
APACHESBLMED	Medium	BLACK	
APACHESBLLGE	Large	BLACK	
APACHESBLXL	X Large	BLACK	
APACHESBLXXL	XX Large	BLACK	

PRO-TWILL TROUSERS



- Lightweight 235g twill material with Cordura reinforced knees
- Tuck away holster pockets
- Phone/knife pocket in the leg, tunnel belt loop to the rear and two large rear pockets.

CODE	SIZE	COLOUR	PER SET
APACHETWILL32	W32 XL 31	BLACK	
APACHETWILL34	W34 XL 31	BLACK	
APACHETWILL36	W36 XL 31	BLACK	
APACHETWILL38	W38 XL 31	BLACK	

APACHE KNEE PADS



CODE	COLOUR	PER SET
APACHEKNEE	BLACK	

NICKEL BELT BUCKLE



CODE	COLOUR	PER SET
APACHEBELT	BLACK	

SAFETY

SAFETY

HI VIS T SHIRT



CODE: CL8586 MED, CL8587 LARGE, CL8589 X LARGE
This 2 band & brace Hi Vis T-Shirt is one of our most popular hi-vis products. The polyester fabric combines both durability and breathability - providing you with exceptional comfort all day long.

Conforms to EN ISO 20471 Class 2 (Yellow only)

- 2 band & brace
- 100% polyester fabric
- Breathable

Construction, Driving, Event Marshalling, Security, Traffic

HI VIS POLO SHIRT



CODE: CLHVJ210CM MED, CLHVJ210CL LARGE, CLHVJ210XL X LARGE

For a smarter alternative to a standard t-shirt, why not go for a Hi Vis Polo Shirt?

Conforms to EN ISO 20471 , also available in compliant orange,

- 2 band & brace
- 100% polyester piqué fabric
- Ribbed collar and cuffs
- Three button placket

Construction, Driving, Event Marshalling, Security, Traffic

APACHE INDUSTRY TROUSERS



- Made from 260g Poly Cotton with bottom loading knee pad pockets
- Hammer loop and ruler pocket
- Button fastening pockets at the rear
- 65% Polyester, 35% Cotton

CODE	SIZE	COLOUR	PER SET
APACHEITBL32	W32 XL 31	BLACK	
APACHEITBL34	W34 XL 31	BLACK	
APACHEITBL36	W36 XL 31	BLACK	
APACHEITBL38	W38 XL 31	BLACK	
APACHEITNA32	W32 XL 31	NAVY	
APACHEITNA34	W34 XL 31	NAVY	
APACHEITNA36	W36 XL 31	NAVY	
APACHEITNA38	W38 XL 31	NAVY	

APACHE HOODED SWEATSHIRT



- Reinforced woven elbow patches for extra durability and comfort
- Double opening pouch pockets
- Heavy rib detail to hem and cuffs
- Machine washable 65% Polyester, 35% Cotton
- Adjustable pull cord on hood

CODE	SIZE	COLOUR	PER SET
APACHEHSWBLMED	M	BLACK	
APACHEHSWBLLRGE	L	BLACK	
APACHEHSWBLXL	XL	BLACK	
APACHEHSWBLXXL	XXL	BLACK	
APACHEHSWGRMED	M	GREY	
APACHEHSWGRLGE	L	GREY	
APACHEHSWGRXL	XL	GREY	
APACHEHSWGRXXL	XXL	GREY	

APACHE SOFT SHELL JACKET



- Micro fleece lined
- Water repellent breathable soft shell jacket
- Velcro adjustable cuffs
- Zipped pockets

CODE	SIZE	COLOUR	PER SET
APACHEHSSJMED	M	BLACK/GREY	
APACHEHSSJLGE	L	BLACK/GREY	
APACHEHSSJXL	XL	BLACK/GREY	
APACHEHSSJXXL	XXL	BLACK/GREY	

APACHE DRY MAX POLO SHIRT



- Lightweight and breathable
- 100% knitted polyester fabric
- Moisture wicking for dryness

CODE	SIZE	COLOUR	PER SET
APACHEPMED	M	BLACK	
APACHEPLGE	L	BLACK	
APACHEPXL	XL	BLACK	
APACHEPXXL	XXL	BLACK	

APACHE HOLSTER TROUSER



CODE	SIZE	COLOUR	PER SET
APACHEHTB/G32	W32 XL 31	BLACK/GREY	
APACHEHTB/G34	W34 XL 31	BLACK/GREY	
APACHEHTB/G36	W36 XL 31	BLACK/GREY	
APACHEHTB/G38	W38 XL 31	BLACK/GREY	
APACHEHTB32	W32 XL 31	BLACK	
APACHEHTBL34	W34 XL 31	BLACK	
APACHEHTBL36	W36 XL 31	BLACK	
APACHEHTBL38	W38 XL 31	BLACK	

ELECTRICAL



NEW!

2 IN 1 CABLE REEL

CR100LED



10 METRE CABLE



13AMP



220/240 V AC



X2 GANG



ELECTRICAL

ELECTRICAL

NEW!

PORTABLE BLUETOOTH SPEAKER LIGHT

EL2169LED

**MAGNETIC FEET****LOUDSPEAKER****OUTLET SOCKET****BLUETOOTH****USB CHARGER**

ELECTRICAL

ELECTRICAL

SAFELINE INDUSTRIAL QUALITY REELS

2 X USB CHARGERS



CRP 175 CRP 200

- HEAVY DUTY WIDE HANDLE
- REEL LOCK
- THERMAL CUT OFF
- IRELANDS FIRST USB PORT CHARGER CABLE REEL
2X USB CHARGING PORTS
- 4 X SOCKETS
- SEALED PLUG

CRP 225 CRP 250

- HEAVY DUTY WIDE HANDLE
- REEL LOCK
- 2 X HEAVY DUTY SOCKET
- THERMAL CUT OFF
- HEAVY DUTY PLUG



ELECTRICAL

ELECTRICAL

CRP 300 CRP 350

- HEAVY DUTY WIDE HANDLE
- REEL LOCK
- 2 X HEAVY DUTY SOCKETS
- THERMAL CUT OFF
- HEAVY DUTY PLUG



SAFELINE INDUSTRIAL QUALITY REELS



CODE	DESCRIPTION	PRICE	BOX QTY
CRP175	PLATINUM 25MT X 240V X 13A 2.5SQ BLUE CABLE		2
CRP200	PLATINUM 40MT X 240V X 13A 2.5SQ BLUE CABLE		2

CODE	DESCRIPTION	PRICE	BOX QTY
CRP225	PLATINUM 25MT X 240V X 16A 2.5 SQ BLUE REEL		2
CRP250	PLATINUM 40MT X 240V X 16A 2.5 SQ BLUE REEL		2



CODE	DESCRIPTION	PRICE	BOX QTY
CRP300	PLATINUM 25MT X 110V X 16A 2.5 SQ YELLOW		2
CRP350	PLATINUM 40MT X 110V X 16A 2.5 SQ YELLOW		2



ELECTRICAL

ELECTRICAL

DOMESTIC 220V REELS WITH PVC CABLE

CODE	DESCRIPTION	PER 1
CR100	10 MTR 1.0SQ PVC CABLE 13AMP	
CR125	25 MTR 1.0SQ PVC CABLE 13AMP	
CR150	50 MTR 1.25SQ PVC CABLE 13AMP	
CR160	50 MTR 1.5SQ PVC CABLE 13AMP	



220V 13AMP INDUSTRIAL REEL 13 AMP SOCKET BLUE CABLE

CODE	DESCRIPTION	PER 1
CR175	25MTR 2.5SQ BLUE ARTIC CABLE 13AMP	
CR200	40 MTR 2.5SQ BLUE ARTIC CABLE 13AMP	



220V 16AMP INDUSTRIAL REEL 16 AMP SOCKET BLUE CABLE

CODE	DESCRIPTION	PER 1
CR225	25MTR 2.5SQ BLUE ARTIC CABLE 16 AMP	
CR250	40MTR 2.5SQ BLUE ARTIC CABLE 16 AMP	

110V 16AMP INDUSTRIAL REEL 16 AMP SOCKET YELLOW CABLE

CODE	DESCRIPTION	PER 1
CR300	25MTR 2.5SQ YELLOW ATRIC CABLE 16AMP	
CR350	40MTR 2.5SQ YELLOW ARTIC CABLE 16AMP	



110V 16AMP INDUSTRIAL REEL 16 AMP SOCKET YELLOW CABLE

CODE	DESCRIPTION	PER 1
CR275	25MTR 1.5SQ YELLOW ATRIC CABLE 16AMP	
CR325	50MTR 1.5SQ YELLOW ARTIC CABLE 16AMP	

110V STEEL CABLE REEL 16 AMP SOCKET YELLOW CABLE

CODE	DESCRIPTION	PER 1
CR300S	25MTR 2.5SQ YELLOW ARTIC CABLE 16AMP	
CR350S	40MTR 2.5SQ YELLOW ARTIC CABLE 16AMP	

HEAVY DUTY ROBUST METAL FRAME CABLE REEL, IDEAL FOR HIRE SHOPS AND CONSTRUCTION



240V STEEL CABLE REEL 13 AMP SOCKET BLUE CABLE

CODE	DESCRIPTION	PER 1
CR175S	25MT X 240V 13A 2.5SQ STEEL REEL	

HEAVY DUTY ROBUST METAL FRAME CABLE REEL, IDEAL FOR HIRE SHOPS AND CONSTRUCTION



ELECTRICAL

ELECTRICAL



3 WAY ADAPTOR 110V

EL2151
Box qty : 2



3 WAY ADAPTOR 220V

EL2191
BOX QTY 2



COUPLER 16AMP

EL2120 110V(YELLOW) 16AMP
EL2121 220V(BLUE) 16AMP

COUPLER 32AMP

EL2122 (RED)32AMP 4 PIN
EL2113 (YELLOW) 32AMP
EL2123 (BLUE) 32AMP
BOX QTY 10



PLUG TOPS 16 AMP

EL2117 110V 16AMP(YELLOW)
EL2118 220V 16AMP (BLUE)

PLUG TOPS 32AMP

EL2119 32AMP (RED) 4 PIN
EL2114 32AMP (YELLOW)
EL2124 32 AMP (BLUE)
BOX QTY 10

ELECTRICAL

ELECTRICAL



WALL MOUNTED SOCKETS

EL2127 16AMP 110V
EL2126 16AMP 220V
EL2128 32AMP RED 4 PIN
BOX QTY 10
EL2139 32AMP 240V
EL2128 32AMP 110V



13 TO 16 AMP ADAPTOR

EL2129
BOX QTY 10

SAFELINE 13 / 16 AMP FLY LEAD



CODE: **EL2108**

220V X 16AMP CEE PLUG

220V X 13AMP SINGLE RUBBER SOCKET

3 CORE X 1.5 BLUE CABLE



CODE: **EL2107**

220V X 16AMP CEE PLUG

220V X 13AMP DOUBLE RUBBER
SOCKET

3 CORE X 1.5 BLUE CABLE



CODE: **EL2291**

outdoor double socket with switches

weather proof ip66 rating

Boxes of 10

SAFELINE 110V INDUSTRIAL EXTENSION LEAD

CODE: **EL2290**

14MTR - 50FEET / 2.5mm, 3 CORE CABLE
MAX LOAD: 110GV, 16A, 1760 WATTS

CODE: **EL2108AP**

25 M 110V LEAD PLUG AND SOCKET
- 16 AMP - 2.5MM CABLE

CODE: **EL2108AP32**

40 M 110V PONY LEAD PLUG
AND SOCKET
- 32 AMP - 2.5MM CABLE



SAFELINE 220V INDUSTRIAL EXTENSION LOOSE LEAD

CODE: **EL2108AB**

15MTR LEAD 13AMP SOCKET AND PLUG

CODE: **EL2108A**

25MTR LEAD 13AMP SOCKET AND PLUG



CODE: **EL2148**

SINGLE RUBBER SOCKET



CODE: **EL2148**

DOUBLE RUBBER SOCKET





ELECTRICAL

ELECTRICAL

TOOL TRANSFORMERS

CODE	DESCRIPTION	PER 1
T3000	3.3KVA Tool Transformer	
T5000	5 KVA Transformer	
T3V	3KVA Continuous rated, 1 x 32amp outlet. Specially designed for use with 115V Heaters. They are only sold with pallet orders, if sold on their own there will be a carriage charge of €30.00	
T10	10 KVA Portable Transformer	
T103PHASE	10 KVA 3 PHASE PORTABLE TRANSFORMER	



ELECTRICAL

ELECTRICAL

ARTIC CABLE

EL2217	1.5MM BLUE CABLE 2 CORE	
EL2218	1.5MM BLUE CABLE 3 CORE	
EL2219	2.5MM BLUE CABLE 3 CORE	
EL2220	1.5MM YELLOW CABLE 2 CORE	
EL2221	1.5MM YELLOWCABLE 3 CORE	
EL2222	2.5MM YELLOW CABLE 3 CORE	



PLUG TOPS 13AMP

EL2110	RUBBER	12 PC/BOX
EL2110A	BAKELITE	12 PC/BOX
EL2111	STANDARD	20 PC/BOX



2 WAY SOCKET

EL2103	10 PC/BOX
--------	-----------



13 AMP FUSES CARDE

EL2104	4 PC/CARD	25 CARDS/BOX
--------	-----------	--------------



4-WAY EXTENSION LEAD

13amp 2MTR LEAD WITH NEON LIGHT
CODE: EL2147

ELECTRICAL

ELECTRICAL

6 WAY EXTENSION LEAD

CODE: EL2206E
BOX QTY: 20PCS

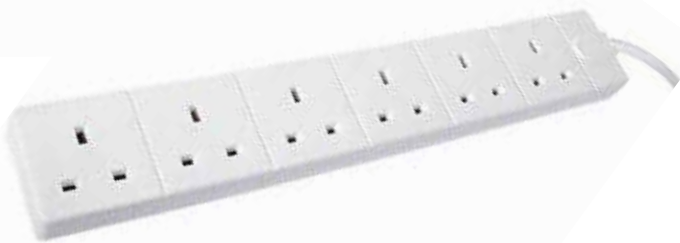

8 SOCKET EXTENSION LEAD WITH SURGE PROTECTION

CODE: **EL2212**

- 1.5MTR CABLE
- PROTECTS AGAINST 6000v SURGES (L/N-PE)
- WITH ON/OFF SWITCH LIGHT AND CHILD SAFEY FEATURE.
- POWER -ON INDICATOR FOR SURGE PROTECTION.
- BOX QTY:10PCS





CABLE CLIPS

CODE	DESCRIPTION	PRICE PER 1	BOX QTY
CCC425	CABLE CLIPS CIRCLE 4.0MM X 50 PCS		50
CCC4100	CABLE CLIPS CIRCLE 4.0MM X 100 PCS		100
CCC725	CABLE CLIPS CIRCLE 7.0MM X 50 PCS		50
CCC7100	CABLE CLIPS CIRCLE 7.0MM X 100 PCS		100
CCF725	CABLE CLIPS FLAT 7.0MM X 50 PCS		50
CCF7100	CABLE CLIPS FLAT 7.0MM X 100 PCS		100
CCC1025	CABLE CLIPS CIRCLE 10.0MM X 50 PCS		50
CCC10100	CABLE CLIPS CIRCLE 10.0MM X 100 PCS		100
CCF1025	CABLE CLIPS FLAT 10.0.0MM X 50 PCS		50
CCF10100	CABLE CLIPS FLAT 10.0.0MM X 100 PCS		100
CCF1425	CABLE CLIPS FLAT 14.0.0MM X 50 PCS		50
CCF14100	CABLE CLIPS FLAT 14.0.0MM X 100 PCS		100



CABLE TIES

CODE	DESCRIPTION	PRICE PER 1	BOX QTY
CTMULTI	CABLE TIE MULTI PACK 650PCS.		n/a

ELECTRICAL

ELECTRICAL

BLACK CABLE TIES

PART NO	LENGTH (MM)	WIDTH (MM)	PACK QTY	PRICE (100)	PRICE (1,000)
CTB100	100mm	2.5mm	100 ties		
CTB150	150mm	3.6mm	100 ties		
CTB200	200mm	4.8mm	100 ties		
CTB250	250mm	4.8mm	100 ties		
CTB300	300mm	4.8mm	100 ties		
CTB350	350mm	4.8mm	100 ties		
CTB450	450mm	4.8mm	100 ties		
CTB450L	450mm	7.8mm	100 ties		
CTB550	550mm	7.6mm	100 ties		
CTB710	710mm	9.0mm	100 ties		
CTB790	790mm	9.0mm	100 ties		
CTB900	900mm	9.0mm	100 ties		
CTB3007	300mm	6.8mm	100 ties		
CTB3008	300mm	7.6mm	100 ties		



WHITE CABLE TIES

PART NO	LENGTH (MM)	WIDTH (MM)	PACK QTY	PRICE (100)	PRICE (1,000)
CTW100	100mm	2.5mm	100 ties		
CTW150	150mm	3.6mm	100 ties		
CTW200	200mm	4.8mm	100 ties		
CTW250	250mm	4.8mm	100 ties		
CTW300	300mm	4.8mm	100 ties		
CTW350	350mm	4.8mm	100 ties		
CTW450	450mm	4.8mm	100 ties		
CTW450L	450mm	7.8mm	100 ties		
CTW550	550mm	7.6mm	100 ties		
CTW710	710mm	9.0mm	100 ties		
CTW790	790mm	9.0mm	100 ties		
CTW900	900mm	9.0mm	100 ties		
CTW3007	300mm	6.8mm	100 ties		
CTW3008	300mm	7.6mm	100 ties		



***THERE ARE NO DISCOUNTS FOR QUANTITIES LESS THAN 1,000**

***PLEASE NOTE THE FOLLOWING: CABLE TIES ARE ONLY SOLD IN BAGS OF 100**

LED UPRIGHT LIGHT

NEW!

FEATURES

- Rechargeable
- 36 W LED
- 3000 LUMENS
- Low energy consumption
- Non-slip out feet
- 220V Charging kit

EL2157C

5 HOURS
100% POWER
OUTPUT

8 HOURS
50% POWER
OUTPUT

12 HOURS
20% POWER
OUTPUT

RECHARGEABLE



INCLUDES RECHARGE KIT

ELECTRICAL

ELECTRICAL

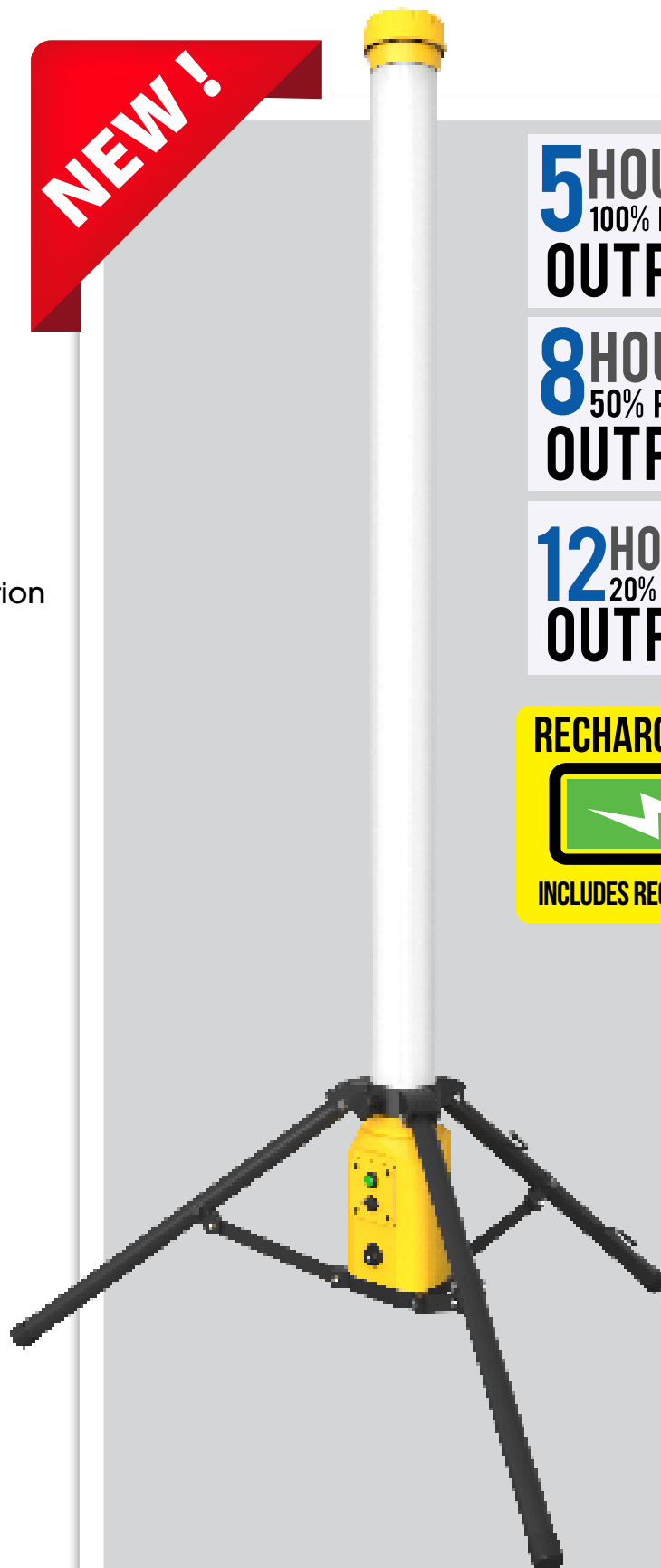

LED CONTRACTORS WORKLIGHT

FEATURES

- 110 Volts
- 2Ft A Frame coated steel with polycarbonate body and carry handle
- Robust foldaway stand for ease of

EL2169ALED



ELECTRICAL

ELECTRICAL

FEATURES

- 2x30 WATT
- 5280 LUMENS
- 2x16AM SOCKETS
- 5M 16AM PLUG
- 2Ft A Frame coated steel with polycarbonate body and carry handle
- Robust foldaway stand for ease of transportation

EL2169BLED



SCAFFOLD POLE LED LIGHT

FEATURES

- 20 WATT
 - 2000 LUMENS
 - 16AMP PLUG & SOCKET
 - 3M CABLE
 - Dual fitting on Scaffold poles or flat surfaces
- Quick and easy to install
 - 2ft Batten fitted with 3M Cable
 - 110V or 220V Compatible
 - Non-Corrosive

NEW!

FIXES TO SCAFFOLD POLE

CAN ALSO FIX TO FLAT SURFACES USING BRACKETS

EL2600BT

LED FESTOON KITS

FEATURES

- 10 Bulbs
- 5 WATTS
- 110VOLTS
- 22 METERS
- 2x0.75mm²

EL2168LED22 - 22M



IP66

FEATURES

- 20 Bulbs
- 5 WATTS
- 110VOLTS
- 50 METERS
- 2x0.75mm²

EL2168LED50 - 50M



IP66

Each light is made from shockproof plastic with frosted lens caps.
Suitable for use on building sites.

FEATURES

- Voltage: 110
- Lamp Base: LED SCREW
- Lamps (Included): 33/10pcs 10W LED
- Kit Length: 100m or 25m
- 2.5sqmm 2core cable PVC Arctic grade cable
- Plug: 16A, 110V, pre-wired
- Wattage: 33/10 x 10W
- Lumen Output: 701 per lamp
- IP Rating: IP44



FESTOON LIGHT

CODE	DESCRIPTION	WATT	PER LIGHT	BX QTY	BULB FITTINGS
EL2167LED	100 METRE	10WATT	3 M SPACING		LED
EL2168LED	25 METRE	10WATT	2.5 M SPACING		LED

EACH KIT INCLUDES, HOLDER CAGE AND BULBS.

ELECTRICAL

ELECTRICAL

LED BATTEN

FEATURES

- 20 WATT
- 2000 Lumens
- Pre -Wired with junction Box
- Quick and easy to install
- 2ft fitted with 1M Cable
- 1M Cable
- 110-220V Compatible
- Non-Corrosive

EL2300BT

NEW!



FEATURES

- 20 WATT
- 2000 Lumens
- Pre -Wired with junction Box
- Quick and easy to install
- 2ft fitted with 1M Cable
- 1M Cable
- 110-220V Compatible
- Non-Corrosive

EL2500BT

NEW!



**3 HOURS
EMERGENCY
BATTERY**

FEATURES

- 40 WATT
- 4000 Lumens
- Pre -Wired with junction Box
- Quick and easy to install
- 4ft fitted with 1M Cable
- 1M Cable
- 110-220V Compatible
- Non-Corrosive

EL2400BT

NEW!



ELECTRICAL

ELECTRICAL



DISTRIBUTION SPIDER 110V

CODE	DESCRIPTION	PER 1
HL-E42A	3 WAY DISTRIBUTION SPIDER SPLITTER 110V	



DISTRIBUTION BOX

CODE	DESCRIPTION	PER 1
4WDB	4 Way Distribution Box	

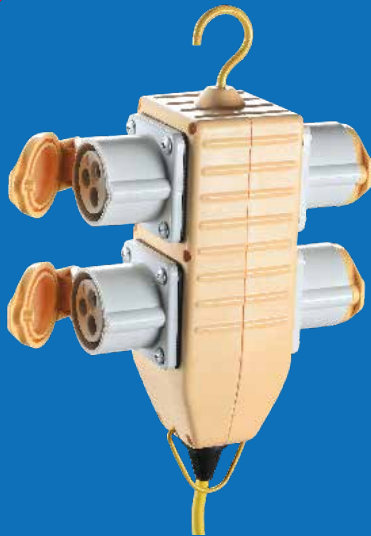

4-WAY SPLITTER

4WDBHANG

DISTRIBUTION BOX



4WDBUSB



ELECTRICAL

ELECTRICAL

LED RECHARGEABLE FLOODLIGHT

INCLUDES MAGNETIC FEET

FEATURES

- Life time: 30000h
- CRI:>70
- Beam angle: 120 degree
- Material: Aluminum+Glass
- IP rating: IP65



INCLUDES CAR CHARGING KIT



EL2175LED - 20WATT
(1400 LUMENS)

EL2176LED - 30WATT
(2100 LUMENS)

EL2177LED - 50WATT
(3500 LUMENS)

ELECTRICAL

ELECTRICAL

LED RECHARGEABLE

FEATURES

- Charger input: 100-240V
- Charger output: 12.6V 1A
- Battery: 11.1V 4400MAH
- Luminous efficiency: 70lm/w
- Color temperature: 2700-
- Life time: 30000h
- CRI: >70
- Beam angle: 120 degree
- Material: Aluminum+glass
- IP rating: IP65

INCLUDES CAR CHARGING KIT



EL2173LED (10 WATT)



EL2174LED (20 WATT)

ELECTRICAL

ELECTRICAL

LED FLOODLIGHT

FEATURES

- 240V and 110V
- 500 Watt Bulb
- Weatherproof
- Painted Metal Case
- Three Piece Telescope Stand
- Flexible Length from 0.8 to 2m
- Including Halogen Lamp
- IP44

TELESCOPIC DOUBLE
EL2154LED - 110V(20WATT)
EL2158LED - 240V(20WATT)



ELECTRICAL

TELESCOPIC SINGLE
EL2153LED - 110V(20WATT)
EL2159LED - 240V(20WATT)



ELECTRICAL

PLASTERERS LED LIGHT

FEATURES

- LED In-tray Array
- Low Energy but Bright LED White Light
- IP65 Weatherproof Rated
- Polycarbonated Diffuser
- Mounted on an Adjustable Height Tripod Stand
- Complete with 2 Power Take Off Sockets for Linking Lights Together

EL2187LED - 2FT (20WATT)



ELECTRICAL



ELECTRICAL

EL2188LED - 5FT (40WATT)

LED GLOBE 360 DEGREE LIGHT

FEATURES

- LED In-tray Array
- Low Energy but Bright LED White Light
- IP65 Weatherproof Rated
- Polycarbonated Diffuser
- Mounted on an Adjustable Height Tripod Stand
- Complete with 2 Power Take Off Sockets for Linking Lights Together

EL2183LED - 30WATT (2600LM)

ELECTRICAL



ELECTRICAL

LED PORTABLE

FEATURES

- Input: 86-264V,50/60Hz
- Power: 30W
- Luminous efficiency:85lm/w
- Color temperature: 2700-6500K
- Life time: 30000h
- CRI: >70
- Beam angle: 120 degree
- Material: Aluminum+glass
- IP rating: IP65

EL2162LED - 30WATT (240V)
EL2163LED - 30WATT (110V)

BOX QTY: 8



ELECTRICAL

ELECTRICAL

LED LIGHTING

EL2164LED - 20WATT



EL2165LED - 20WATT
WITH SENSOR



EL2166LED - 50WATT
WITH SECURITY GRILL



ELECTRICAL

ELECTRICAL

LED TASK LIGHT

EL2172LED - 220V (20WWATT)

EL2171LED - 110V (20WWATT)



LED 50WATT PORTABLE WORKLIGHT INCL USB OUTLET SOCKET & SPEAKER

EL2170LED - 220V (4000LM)



ELECTRICAL

ELECTRICAL

230° SENSOR LIGHT

USB RECHARGEABLE



CODE: EL2194USB

LUMENS

350

WORKING TIME

2.5-8 HOURS

• HIGH EFFICIENCY COB LED
6XPE LED LIGHTS



LED HEADLAMP

USB RECHARGEABLE



CODE: EL2192LED

- 5 LIGHT MODES
- HIGH 80 LUMEN LOW 40 LUMEN
- USB CHARGE
- RE LIGHT STED - BLINK



LED HEADLIGHT



CODE: EL2192

- 3 LED HEAD TORCH
- 40 LUMENS
- ADJUSTABLE HEAD STRAP
- 3 WHITE LED
- REQUIRES 3 AAA BATTERIES (INCLUDED)



LED HEADLIGHT

**BUY 9
GET 1
FREE**

EACH



- 3 LED HEAD TORCH
- 40 LUMENS
- ADJUSTABLE HEAD STRAP
- 3 WHITE LED
- REQUIRES 3 AAA BATTERIES (INCLUDED)



LED HEADLAMP

USB RECHARGEABLE

**BUY 9
GET 1
FREE**

EACH

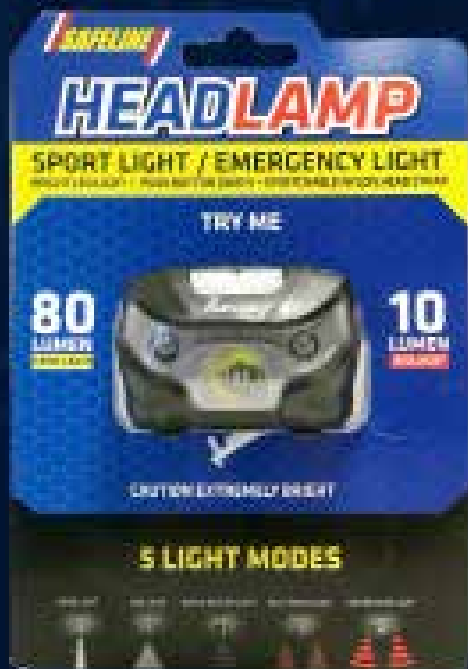

- 5 LIGHT MODES
- HIGH 80 LUMEN LOW 40 LUMEN
- USB CHARGE
- RE LIGHT STED - BLINK

LED WORK LIGHT

**BUY 10
GET 2
FREE**

EACH



- SPOTLIGHT 80 LUMENS
- 4 AAA BATTERIES (INCLUDED)
- WITH ROTATED STAND AND MAGNETIC BASE
- HOOK TO HANG
- MAGNETIC BASE

NEW!

LED PORTABLE POCKET TORCH

EL2189LED

- **60LUMENS**
- **10WATT**
- **220-240VOLTS**



INCLUDES 6 PC DISPLAY BOX

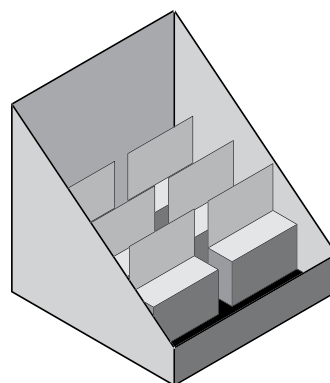

ELECTRICAL

ELECTRICAL

PORTABLE WORK LIGHT (HALOGEN) 500WATT

- BRIGHT NATURAL WHITE LIGHT
- FULLY WEATHERPROOFED IP44
- DIECAST ALUMINUM HOUSING
- 118MM HALOGEN BULB,500W
- APROX. 2M CABLE
- EASY GRIP HANDLE
- ADJUSTABLE LAMP HEAD

CODE	DESCRIPTION	PER 1	BOX QTY
EL2163	Mini Floor Light 110 Volt		8



**FREE
2
BULBS**



CONTRACTORS LINK LIGHT (BOX OF 2)

CODE	DESCRIPTION	PER 1
EL2169	110V Contractors link Lights (2)	

REPLACEMENT BULB FOR LINK LIGHT

CODE	DESCRIPTION	PER 1
EL2137	2FT 18W FLOURESCENT BULB FOR LINK LIGHTS	

ES BULB

- FESTOON BULB (QUANTITIES 100)
- 60wATT
- 110vOLT
- ES

CODE	DESCRIPTION	BX QTY	PRICE	BULB FITTINGS
EL2136	60WATT X 110V ES BULB	50		ES
EL2136LED	10WATT X 110V LED BULB	50		LED



360 DEGREE UPRIGHT LIGHT LED

EL2157

- Collapsible locking tripod base.
- Integrated power cord (110V)
- Non-slip out feet
- Low Energy consumption
- 20,000 hrs lamp life hours
- Lighting Range: 20-30ft

UPRIGHT REPLACEMENT BULB FOR OLD EL2157 MODEL

EL2157B



ELECTRICAL

ELECTRICAL

TELESCOPIC SITE LIGHTS

- 240V and 110V
- 500 Watt Bulb
- Weatherproof
- Painted Metal Case
- Three Piece Telescope Stand
- Flexible Length from 0.8 to 2m
- Including Halogen Lamp
- IP44

CODE	DESCRIPTION	PER LIGHT	BX QTY
EL2159	220V SINGLE SITE LIGHT		4
EL2153	110V SINGLE SITE LIGHT		4



ELECTRICAL

ELECTRICAL

SITE LIGHTING

CODE	DESCRIPTION	PER LIGHT	BX QTY
EL2160	Halogen Site Single Lights		1
EL2161	Halogen Site Double Lights		1



HALOGEN LAMP

FEATURES

- BRIGHT NATURAL WHITE LIGHT
- FULLY WEATHERPROOFED IP44
- DIECAST ALUMINUM HOUSING
- 118MM HALOGEN BULB, 500W
- APROX. 2M CABLE
- EASY GRIP HANDLE
- ADJUSTABLE LAMP HEAD

EL2164 - C/W BULB



FREE
2
BULBS

EL2165 - WITH PIR DETECTOR



FREE
2
BULBS



TIMERS		
CODE	DESCRIPTION	PER 1
EL2156	WEEKLY TIMER	

PRE PACKED HALOGEN BULBS

CODE	VOLT	WATT	TWIN PK	BOX QTY
EL2179	110V	500 Watt		30
EL2180	110V	300 Watt		30
EL2181	240V	500 Watt		30
EL2182	240V	300 Watt		30



ELECTRICAL

ELECTRICAL



TASK LIGHT		
CODE	DESCRIPTION	PRICE
EL2171	110V 38W TASK LIGHT	
EL2172	220V 38W TASK LIGHT	

TASK LIGHT

CODE	DESCRIPTION	PRICE
EL2177	110V REPLACEMENT BULB	
EL2178	220V REPLACEMENT BULB	





Code: **BLR20**

Duracell D Type
Bx Qty:
10pk of 2= 20 Batteries

Code: **BLR14**

Duracell C Type
Bx Qty:
10pk of 2= 20 Batteries

Code: **BLR61**

Duracell 9V Type
Bx Qty:
10pk = 10Batteries



Code: **BLR034**

Duracell AAA Type
Bx Qty:
10pk of 4 - 40 Batteries

Code: **BLR64**

Duracell AA Type
Bx Qty:
20pk of 4 = 80 Batteries



Code: **BLR0312**

Duracell AAA Type
Bx Qty:
20pk of 8 = 160 Batteries

Code: **BLR68**

Duracell AA Type
Bx Qty:
12pk of 8 = 96 Batteries

Code: **BLR615**

Duracell AA Type
Bx Qty:
12 pc pack

ELECTRICAL

ELECTRICAL



WATER PUMP

CODE	DESCRIPTION	PRICE
LB480	2" SUBMERSIBLE PUMP 110V	
LB480/1	SPARE CABLE	
LB480/F	2" SUB PUMP C/W FLOAT 110V	

ELECTRICAL

ELECTRICAL

PUDDLE PUMP

CODE	DESCRIPTION	PRICE
LSC4	1" PUDDLE PUMP 110V	



NEW TO OUR RANGE

RHYTHMIC HEADPHONES

Code: **BLEAR**

1.2 METER CORD, BLISTER PACKED WITH EURO SLOT FOR DISPLAY PURPOSES.

SOLD IN BOX QTY OF 20



9 FIN OIL FILLED HEATER

Code: **OH-B159**

- VOLTAGE: 220V – 240V
- 2.0KW
- ADJUSTABLE THERMOSTAT
- TRIPLE OVERHEAT PROTECTION
- OPERATION SWITCHES WITH INDICATOR LIGHTS



ELECTRICAL

ELECTRICAL

CONVECTOR HEATER 240V X 2KW

- Adjustable thermostat
- 3 heat settings @ 750W, 1250W and 2000W
- Auto safety cut-out
- Built-in safety thermal fuse
- Free standing or wall mountable

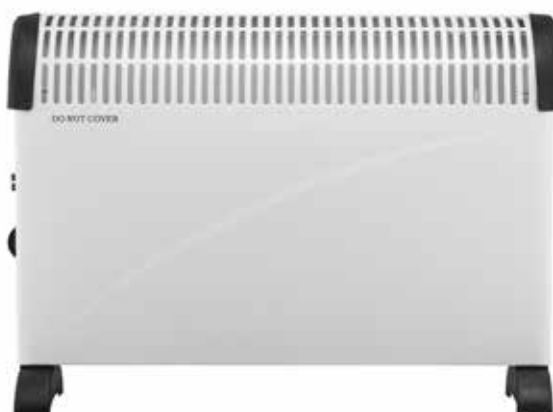

HIGH QUALITY LAY FLAT WATER PUMP HOSE MADE FROM REINFORCED PVC



LENGTH

100M

DIAMETER

2"

BAR

4

ELECTRICAL

High-quality lay flat water pump delivery hose made from reinforced PVC with a 2" diameter and is 100 metres in length.

INFRARED PATIO HEATER

- Keeps you toasty in the garden all year round
- Wall-mounted, tilting design, safely out of reach
- 3 heat levels offer adjustable comfort
- Heats up to 20m² -
- Golden tube heating element delivers instant heat
- A natural light creates lower UV levels and less glare
- The remote control makes it easy to operate
- Dimensions: H 11 x W 68 x D 7cm
- 2kw - 1.9m m cable includes 13 amp plug
- IP65

code: HEATPATIO

ELECTRICAL



*** INCLUDES
REMOTE**



Outdoor Heaters

- Aluminium casing and stainless steel grill for long life
- Sheathered heating element with quartz glass tube
- Latest carbon heating element with 5,000 hours running
- IP65 protection is suitable for outdoor and indoor
- Max. Adjustable angle 45°
- 2000 Watt
- ON/OFF Switch

CODE: HEATPATI02

HEATER

HEATPOD - 220V (HEATER WITH TRIPOD)

HEATCER110 - 110V
HEATCER220 - 220V



ELECTRICAL

ELECTRICAL

SMOKE DETECTORS



ULTRAMAX SMOKE DETECTOR JBC02 WITH ALK1

Code: **EL2226**



ULTRAMAX CARBON MONOXIDE DETECTOR JBC01

Code: **EL2227**



FIRE BLANKET 1M X 1M

Code: **FIREB1X1**

ELECTRICAL

ELECTRICAL

HOUSEHOLD



DRAUGHT SEAL

E TYPE

AVAILABLE IN BROWN & WHITE

Code: **YL6804EWH**

5M WHITE E TYPE

Code: **YL6804EBR**

5M BROWN E TYPE



DRAUGHT SEAL

P TYPE

AVAILABLE IN BROWN & WHITE

Code: **YL6804PWH**

5M WHITE P TYPE

Code: **YL6804PBR**

5M BROWN P TYPE



FEATURES

- Perfect for doors and window frames.
- Waterproof, Windproof, Excellent aging resistance.
- Easy to cut and easy to install, no requires specialist tool.
- Preventing dust collection between sliding doors or windows.
- Reduce the noise from outside and the sliding door slamming, give you a quiet and comfortable living environment.
- Resist rain and cold wind, give you a clean and warmer environment.
- Protect the window and door, reduce wear on window/door while open and close.

HOUSEHOLD

HOUSEHOLD



LETTER BOX DRAUGHT EXCLUDER

AVAILABLE IN BROWN & WHITE

Code: **YLLBS01B**

LETTER BOX COVER BROWN

Code: **YLLBS01W**

LETTER BOX COVER WHITE



DOOR BRUSH SEAL

91.5CM BRUSH STRIP

AVAILABLE: GOLD, SILVER, BROWN AND WHITE

Code: **YL2801B**
GOLD ALUMINIUM DOOR
BRUSH

Code: **YL2801**
SILVER ALUMINIUM DOOR
BRUSH

Code: **YL1805BB**
BROWN PVC DOOR BRUSH
SEAL

Code: **YL1805AW**
WHITE PVC DOOR BRUSH
SEAL

NEW TO OUR RANGE

FELT TAPE



HOUSEHOLD

HOUSEHOLD

Felt Furniture Scratch Protector Pads Self Adhesive
Floor Wall Chair Table Wood

FELT TAPE

CODE	DESCRIPTION	PRICE	BOX QTY
FELT19	19mm Single Sided Felt Tape		12
FELT25	25mm Single Sided Felt Tape		12
FELT38	38mm Single Sided Felt Tape		12
FELT15X25	15 x 25mm Single Sided Felt Tape		12

SURFACE PROTECTOR



CARPET PROTECTION FILM

CODE	DESCRIPTION	PRICE
PCP100	600mm X 100 metre	
PCP25	600mm X 25 metre	

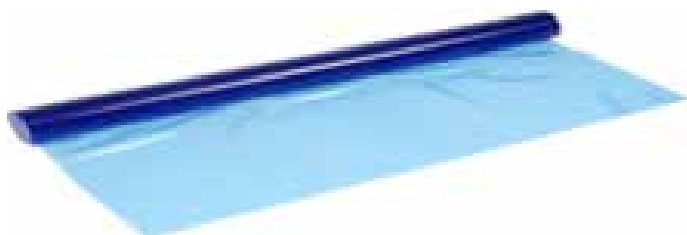

GLASS PROTECTION FILM

CODE	DESCRIPTION	PRICE
PGP100	600mm X 100 metre	
PGP25	600mm X 25 metre	

HOUSEHOLD

HOUSEHOLD



HARD SURFACE PROTECTOR FILM

CODE	DESCRIPTION	PRICE
PHSP100	600mm X 100 metre	
PHSP25	600mm X 25 metre	



**EXTRA HEAVY DUTY
REFUSE BAG
300 GAUGE**

CODE:EP13Z

HOUSEHOLD

HOUSEHOLD



PER ROLL

8 ROLLS PER CARTON



RUBBLE SACK

Code: **RB21**

(20) Roll's per Box

Rim: 1000cm (39"), Length 72.5cm (30")

7 Bags per Roll.



5 PC WOVEN RUBBLE SACK

Code: **EP5PC**

HEAVY DUTY

50CM X 90 CM



POP UP 1 TONNE SKIP BAG

Code: **EPITN**

PP WOVEN

HEAVY DUTY

HOUSEHOLD

JERRY CAN

FEATURES

- Green jerry can
- Suitable for carrying petrol or other fuels
- 20 litre capacity
- Heavy duty metal construction
- Ideal for keeping in the garage or car

Code: **JC206**

4PC PER CARTON

METAL 20LTR JERRY CAN



HOUSEHOLD

TARPAULIN IN STOCK

CODE:TARP5X7

5.4M X 7.0M

PER UNIT
8PCS PER BALE

CODE:TARP3X5

3.5M X 5.4M

PER UNIT
15PCS PER BALE

FEATURES

- EXTRA STRONG DURABLE MATERIAL
- EYELETS EVERY METRE
- TEAR RESISTANT MATERIAL

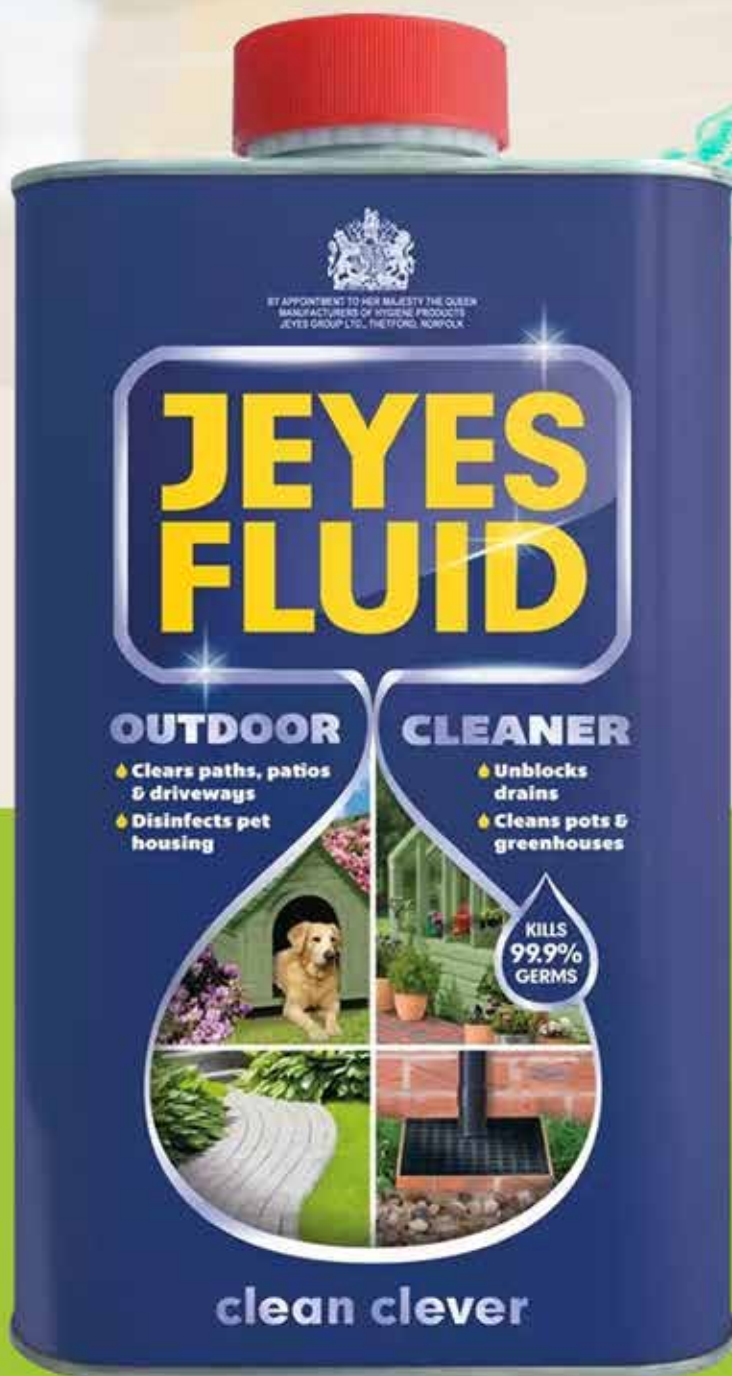

AVAILABLE IN 300ML & 1 LTR

A Powerful Multi-Purpose Outdoor Cleaner Trusted By Millions Of Users To Tackle A Wide Range Of Outdoor Cleaning Jobs. Suitable For Cleaning And Disinfecting Paths, Patios And Driveways, Unblocking Drains. Disinfecting Pet Housing (Hutches, Kennel, Stables, Chicken Coups And Pigeon Lofts), Cleaning And Disinfecting Greenhouses, Flower Pots And Gardening Tools. Ideal For Traditional Users, Comfortable Diluting An Outdoor Cleaner.

- Kills 99.9% of germs.
- Cleans and disinfects water butts, pet areas, paths, patios and greenhouses.
- Cleans and deodorises drains.
- Kill Avian Influenza/Bird Flu.
- Cleans greenhouses, plant pots and tools.
- Cleans and freshens waterbutts.
- Disinfects animal housing/equine.

300ML – 12 PACK
EX VAT
EACH

1LTR – 6 PACK
EX VAT
EACH



8L SPRAY BOTTLE

CODE:MXD8L

- ✓ Long-reach stainless steel lance with adjustable nozzle
- ✓ Pressure-release safety valve
- ✓ Wide funnel-type opening for easy filling
- ✓ Carrying strap & trigger lock for continuous spraying
- ✓ For easy distribution of plant feed, fertiliser & weed killer

Finish: Plastic
 PSI / BAR: 40psi
 Product Weight: 1.258kg
 Capacity - Volume: 8Ltr
 Graduation: Yes

The sprayer is suitable for use with water, diluted plant feeds, weed killer and insecticide. Do not attempt to use with other fluids (paint, wood stain, oil/fuel, solvents, etc.)

now

HOUSEHOLD

HOUSEHOLD

AEROSOL



BUY 5 GET 1 FREE

* BUY 5 CARTONS GET 1 CARTON FREE (12 PCS FOAM FIX PER CARTON)

B1 FIRE FOAM

ALCON
SEALANT

FOAM FIX
PROFESSIONAL



CODE: HHFALCON

AEROSOL

WHILE STOCKS LAST



GENERAL PURPOSE SILICONE

COLOUR: TRANSPARENT

336ML

- Constant elasticity at different temperatures.
- Strong adhesion to glass, ceramic, porcelain, enamel, various metals and painted surfaces.
- Long lasting.

24PCS PER CARTON
CODE:EBGPGALCON

AEROSOL

AC-90 MAINTENANCE SPRAY. LUBRICATED, CLEANS, PENETRATES, PROTECTS METALS, DISPALCES MOISTURE, 1000 + 1 UESE DOES NOT CONTAIN SILICONE

CODE	NAME	DESCRIPTION	PER1
AC1530	AC-90	250ML LIQUID MAINTENANCE	
AC1842	AC-90	415ML AEROSOL	
AC1839	AC-90	500ML AEROSOL	
AC1558		AMAZE DASH SHEEN 500ML AERSOSOL	
AC1843	AS-90	400GRM AEROSOL ANTI SPATTER	
AC1907	BS-90	500ML AEROSOL BUILDERS BITUMAS-TIC COATING	
AC1797	CD-90	500ML AEROSOL EP LUBRICANT	
AC1829	CS-90	500ML HIGH TEMP AEROSOL ANTI SEIZE GREASE	
AC1483	CT-90	500ML BOTTLE C/W SPOUT CUTTING & TAPPING	
AC1846	CT-90	500ML AEROSOL CUTTING & TAPPING FLUID	
AC1487	ESC	500ML AEROSOL ELECTRICAL SWITCH CLEANER	
AC1815	S/STEEL CLEANER	500ML AEROSOL ANTI STATIC FOAM CLEANER	
AC1825	FSL GOLD	400ML AEROSOL FOOD SAFE LUBRICANT	
AC1851	MP OIL 415 ML	AEROSOL MULTI PURPOSE OIL	
AC1827	PT-90 SUPER LUBE	500ML AEROSOL LUBRICANT OIL FOR EVERY DAY USE.	
AC1822	RP-90	500ML AEROSOL RELESASE FLUID	
AC1471	LD-90	400ML AEROSOL GAS LEAK DETECTOR	
AC1845	RL-90	500ML AEROSOL ROPE LUBRICANT	
AC1847	SA-90	500ML AEROSOL IND STRENGTH ADHESIVE SPRAY	
AC1887	SP-90	500ML AEROSOL MAX SILICONE RELEASE	
AC1820	WG-90	500ML AEROSOL WHITE GREASE WATER RESISTANT	
AC1785	ZG-90	500ML SPRAY 2 NOZZLES GALVO SPRAY	
AC1855	RX-90	500ML AEROSOL RED OXIDE	

AC-90 MAINTENANCE SPRAY. LUBRICATED, CLEANS, PENETRATES, PROTECTS METALS, DISPALCES MOISTURE, 1000 + 1 UESE DOES NOT CONTAIN SILICONE

AEROSOL

AEROSOL

ZG-90® COL D ZINC GALVANISING SPRAY

ZG90 is the ideal repair coating for newly galvanised metals. Formulated to look like newly galvanised metal when dry, ZG90 can be used as an undercoat or top coat. The product is fast drying to reduce downtime and delay. ZG90 is suitable as a base for most common finishes. If in doubt try on a small area first to test. (Do not use on the inside of water storage tanks).

Code: **AC1785**

400ML SPRAY

BOX OF 10

Code: **AC1785A**

500ML SPRAY

BOX OF 10

Code: **AC1910**

WHITE 500ML SPRAY

BOX OF 10

Code: **AC1909**

GALVO 900ML TIN BRUSH ON

BOX OF 4

Code: **AC1911**

RED 500ML SPRAY

BOX OF 10

Code: **AC1912**

YELLOW 500ML SPRAY

BOX OF 10

Code: **AC1913**

BLACK 500ML SPRAY

BOX OF 10

Code: **AC1914**

ZINC 500ML BLUE AEROSOL

BOX OF 10



PRO SOLVE SILVER ZINC GALVANISING SPRAY 500ml

Prosolve is recognised as a market leading brand for Maintenance, Marking, Workshop, Coatings and Hand Care. The silver zinc galvanising spray is suitable for use in the production, maintenance and construction industries. This product can be used as a coating on pipes and steel fabrications to reduce corrosion and as an exceptionally good primer coat.

Code: **AC1785E**

500ML SPRAY



DESCRIPTION AND RECOMMENDATIONS

Improved multifunctional EP Grease by plastic deformation of its micro additives and formulated for lubrication under harsh mechanical conditions and long frequency rhythms in lubrication.

APPLICATIONS

For all types of bearings working with heavy loads, vibration or in the presence of moisture.

In flat bearings, including yellow alloy, working with heavy loads or partial rotation abrasion

To protect the vibro-corrosion development or accelerated wear of bearings and cardan transmission grooves and grooved boards with high torque.

Lubrication of rolling mills or calenders by sliding pads.



AEROSOL

AEROSOL

AC-90® LIQUID MAINTENANCE

AC90 DISPLACES MOISTURE - Corrects faults on damp vehicle ignition systems, simply spray over exterior of all distributor leads, spark plug leads and coil leads. Regularly apply AC90 to keep your engine running smoothly.

Suitable for electronic ignition systems

AC90 LUBRICATES - Cleanly restores smooth silent operation to doorhinges, locks, castors, drawer runners and curtain rails. Stops sticking, stops squeaks. AC90 PENETRATES - Rapidly loosens rusted, corroded parts, seized nuts, bolts, cables and metal parts. De-scales taps and showers.

AC90 CLEANS & PROTECTS - Removes dirt, grime, lime scale, crayon marks, chewing gum and adhesive. Leaves a clean protective film to protect against rust.

Removes bloom from fridges, cookers and stainless steel sinks.

If in doubt about suitability try on a small area first.

Protects all metals from corrosion and is ideal for use on items in storage.

DOES NOT CONTAIN SILICONE

Code: **AC1530**

250ML

Code: **AC1842**

415ML

Code: **AC1839**

500ML

CT-90® FOAMCUT

CT90 CUTTING & TAPPING FLUID - is a special fluid which will not break down under extreme pressures. A coating of CT90 will allow swarf and cut chips of metal to be removed by the cutting tool with less friction. Less effort is therefore required to cut even the hardest metal. Cut surface finish is improved and cutting times are reduced.

CT90 has been formulated to be suitable for all types of steel and ceramics, even high tensile steels. Due to the active nature of the product there is a risk of staining if the product is used on some yellow metals.

CS90 DRILLING - Apply CS90 during the drilling operation.

CS90 will increase drilling efficiency and prolong drill bit life.

CT90 THREAD CUTTING - Apply CT90 to the die or tap prior to use and also during the operation. CT90 is suitable for both machine and hand operations and is particularly recommended for pipe work where the risk of thread wall deformation during cutting is reduced.

CT90 HACKSAWING - Apply to the hacksaw blade before and during the sawing operation.

CT90 is suitable for use with power saws and hand saws.

Code: **AC1483**

500ML POLY BTLE

Code: **AC1846**

500ML SPRAY



AEROSOL

AEROSOL

CS-90® ANTI SEIZE GREASE

CS90 - Is a very high copper content anti-seize grease with added graphite, which prevents corrosion, fretting or galling. Use CS90 on screws threads or where metal surfaces mate. CS90 remains effective over long periods of time. Nuts, Studs, and Bolts can be easily removed when treated at time of assembly.

CS90 can be removed with white spirit or normal de-greasing methods. Graphite content allows easy dismantling. The extra fine copper particles in CS90 act as a barrier to corrosion even in harsh conditions.

Code: **AC1829**

500ML TIN

Code: **AC1829**

CS-90 ANTI SEIZE
COMPOUND



RX 90® REDOXIDE ANTI RUST PRIMER

FOR USE ON LIGHTLY RUSTED METAL, OVER COATABLE WITH MOST POPULAR PAINTS, TO OBTAIN THE BEST ANTI RUST PERFORMANCE THE SURFACES TO BE PRIMED MUST BE IN SOUND CONDITION, CLEAN FREE FROM OIL OR GREASE, IF THE SURFACE HAS BEEN PREVIOUSLY PAINTED, REMOVE ALL LOOSE OR FLAKY PAINT WITH A WIRE BRUSH

Code: **AC1855**

500ML SPRAY



RP-90® RAPID PENETRATING SPRAY 500ml AEROSOL

RP-90 is a fast acting penetrating and release fluid 30% less dense than water Giving excellent penetrating power Rapidly frees rusted parts and components

Code: **AC1822**

500ML SPRAY

CD-90® CHAIN & DRIVE LUBRICANT

- Multi viscosity.
- Starts thin for penetration then thickens for performance
- Resists throw off on moving chains.
- CD-90 can also be used as a general heavy duty lubricant.

Ideal for driving chains, bearings, conveyor systems and also can be used as a slideway

Code: **AC1797**
500ML SPRAY



AEROSOL

AEROSOL

MULTI-PURPOSE OIL (with Anti-rust)

- High quality mineral lubricated oil
- Clean for household use yet strong enough for industrial

Contains a special blend of anti-rust agents protecting all treated surfaces against corrosion
Does not contain silicone.

Code: **AC1851**
415ML SPRAY



LD-90 GAS LEAK DETECTOR SPRAY

- Compressed air propellant
- Non-flammable
- Ideal for use with gas detecting equipment
- Micro-porus foam shows up leaks at any location
- All angle spray
- Safe in confined spaces

Safe on skin, clothes, woodwork, metals and plastics. Do not use on medical gas where

Code: **AC1471**
400ML SPRAY



AS-90 WELDING ANTI-SPATTER FLUID

- Strong Anti-Spatter Effect
- Totally Non-Flammable
- No Silicon Content
- Suitable for electric arc or gas welding

Code: **AC1843**
400GRMS



AEROSOL

AEROSOL

RL-90® WIRE ROPE LUBRICANT & PTFE

A clean lubricant with added P.T.F.E. and petroleum jelly.

Extreme pressure performance weather resistant

Compatible with all mineral oil based lubricants

Can be used on wet ropes and provides excellent protection against corrosion

Code: **AC1845**

500ML SPRAY



SA-90® ADHESIVE INDUSTRIAL STRENGTH ADHESIVE

- Construction
- Electrical
- Woodworking
- Farming
- Engineering
- Upholstery & Carpet industries

Suitable for use on soft wood, plywood, plaster board, MDF, laminate board, hardboard,

Code: **AC1847**

500ML SPRAY



SP-90® MAXIMUM SILICONE SPRAY

SP-90 is a superior silicone lubricant for light lubrication in chemical, food and other industries where a clean clear dry lubricating film is preferred. Stable over a wide range of temperatures. Prevents sticking of rubber or plastic parts.

Code: **AC1847**

500ML SPRAY

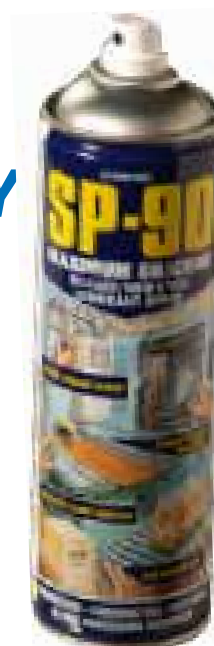

AEROSOL

AEROSOL

ESC PLASTIC SAFE ELECTRICAL SWITCH CLEANER

- A solvent cleaner suitable for parts containing plastics or lacquer
- Leaves no residue
- Removes oil and grease
- Formulated for use on delicate equipment

Always test a small area for suitability before use. Always disconnect

Code: **AC1487**
500ML SPRAY



BS-90 BUILDERS DURABLE BITUMASTIC COATING

- Flexible, waterproof, crack resistant
- Helps stop water leaks
- Easy inverted spray, inverted spray nozzle for ease of application
- Rapid drying formula
- Ideal for sealing roofing tiles, slates, metal parts, fixings

Code: **AC1907**
500ML SPRAY

FSL FOOD SAFE LUBRICANTS

- No mineral oil content
- Lubricates
- Penetrates
- Non toxic
- Prevents rust
- Loosens rusted parts
- No taste
- No smell
- Fully biodegradable

Code: **AC1825**
400ML SPRAY



AEROSOL

AEROSOL

SL 90 VISCOUS LUBRICATING OIL

SL 90 VISCOUS LUBRICATING OIL uses a high quality mineral lubricating oil formulated to have a wide operating range, Clean for house hold use yet strong enough for industrial purposes.

SL 90 VISCOUS LUBRICATING OIL contains a special blend of anti rust agent which will protect all surfaces against corrosion and is formulated to grip metal parts.

SL 90 VISCOUS LUBRICATING OIL has P.T.F.E (POLYTetraFLUOROETHYLENE) added to reinforce the oil film layer and provide lubrication for metal to metal parts for longer periods of time than can be achieved with oil film coating., P.T.F.E has the lowest coefficient of friction (0.1) of any of the solid additive products. P.T.F.E is solid at normal temperatures and is stable up to 260 degrees centigrade, P.T.F.E is non toxic and chemically inert.



Code: **AC1827**

400ML SPRAY

STAINLESS STEEL CLEANER

- RAPIDLY CLEANS/POLISHES STAINLESS STEEL
- ANTI STATIC
- USE ON STAINLESS STEEL SURFACES, ENAMEL PAINT
- SUITABLE FOR KITCHEN FITTINGS, HAND RAILS, VENDING MACHINES, ROAD SIGNS
- FINGER LATES, ALUMINIUM, CHROME, STEEL

Code: **AC1815**

500ML SPRAY



AEROSOL

AEROSOL



MULTI-PURPOSE TORCH



GAS

CODE: GT3577

390ML



TORCH

CODE: GT31057



GAS & TORCH KIT

CODE: GT31057KIT



GAS

MINI BURNER KIT GAS + TORCH

- thread 7/16"
- adjustable flame
- Piezo ignition
- including 1 pc Mini Novacet Plus gas cartridge 60 g
- Mini Novacet Plus gas cartridge can be used upside down
- flame temperature max. 1900 °C
- according to EN417



DOMINATOR



GT405 DOMINATOR SELF LIGHTING HAND TORCH



GAS

GAS

DOMINATOR

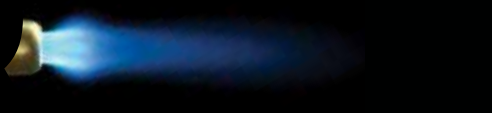

GT5 DOMINATOR TURBO FIRE

- Quick Self Lighting
- Swirl Flame
- Flame Control
- Tip Swivels 360 Degrees
- High Temperature
- Faster Soldering
- Safety Lock
- 1 Year Warranty
- Safety checked and test burned.
- For use with mapp gas and propane gas



GAS

GAS

DOMINATOR

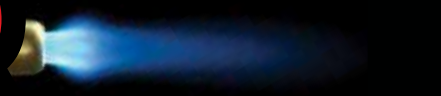

GT5HT DOMINATOR SWIVEL FIRE



GT5K DOMINATOR TURBO FIRE PLUS EXTRA NOZZLE



GAS

GAS

DOMINATOR

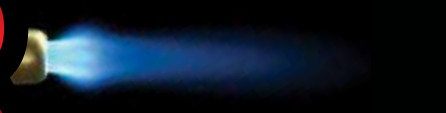

GT52450
DOMINATOR
TURBO TORCH KIT
INCLUDES TURBO FIRE
TORCH



WHAT'S INSIDE THE BOX



GAS

GAS

DOMINATOR



**NEW
FORMULA**

BETTER PERFORMANCE



APPROVAL DATE 29/06/2018

MAP/PRO GAS MIX CYLINDER

Code: **GT2450 (400g)**

- 99.5% PROPYLENE
- CLEANER FLAME
- CLEANER FUEL
- BETTER RESULTS
- BETTER HANDLING
- EFFECTIVE TO -20°C.
- ROBUST STEEL CYLINDER.
- USES STANDARD CGA600 CONNECTION

BOX QTY 12PCS



PROPANE GAS CYLINDER

Code: **GT2400 (400g)**

- HIGHER PRESSURE AND HOTTER FLAME THAN MIXED GAS CARTRIDGES.
- HOT STABLE GAS.
- EFFECTIVE TO -20°C.
- ROBUST STEEL CYLINDER.
- USES STANDARD CGA600 CONNECTION

BOX QTY 12PCS

GAS

GAS

REGULATORS

CODE: **BGR**
MODEL: GF-998

FLIP UP REGULATOR
30 MBAR
1.5K G/H



CODE: **BGRP**
MODEL: G187B

HIGH PRESSURE PUSH ON REG BLUE GT06
INLET PRESSURE ;G0.7~15.6kg/cm²
OUTLET PRESSURE;G0~3 kg/cm²
FLOW CAPACITY ;G0~8 kg/hrj)0~380800
BTU/hrj^
INLET DIAMETER ;G35mm
OUTLET DIAMETER;G10ϕP



CODE: **BGRT**
MODEL: 552

HIGH PRESSURE REG WITH SIDE THREAD
INLET PRESSURE ;G0.7~15.6kg/cm²
OUTLET PRESSURE;G0~3 kg/cm²
FLOW CAPACITY ;G0~8 kg/hrj)0~380800
BTU/hrj^
INLET DIAMETER ;G35mm
OUTLET DIAMETER;GPF3/8"-19-L



GAS

GAS



CODE: **RGRF**

MODEL: 700E

LOW PRESSURE PROPANE RED REGULATOR
FIXED

37MBAR

400GM / HOUR

MAX OUTLET PRESSURE 16BAR



CODE: **RGRN**

MODEL: OTZ

HIGH PRESSURE REDUCER FOR GASEOUS FLUIDS,
BUTANE GAS, PROPANE, NATURAL GAS &
COMPRESSED AIR (& THEIR MIXTURE) REG WITH
NOZZLE

CAPACITY: 12KG/H INLET PRESSURE: MAX 19BAR

WORKING TEMP: -200 + + 500 C



CODE: **RGR**

RED REGULATOR HIGH PRESSURE
RADHP04ROI

GAS

GAS

POWER TORCH PRE PACKED

Code: **GT7020**

- Powerful, high temperature (up to 1520°C) gastorch.
- Solid brass construction.
- Instantly FLARESAFE; use at any angle.
- Ideal for brazing, pipe bending, aluminium welding, automotive.
- **For use with G2400 Propane or 2450 Map/Pro GoSystem gas cylinder**



ALPEN CAMPING GAS

Code: **GT2190 (190g)**

International 190 piecable (80:20) Butane/Propane Mix Gas Cartridge

- Added propane for increase heat and power
- Stable mix gas
- Effective to -10°C

IDEALGAS BLOWTORCH

Code: **GTFFLA3PM**

- Auto ignition Blowtorch suitable for gas cartridge
- 190gr Double diameter ceramic for greater durability
- Quick release cartridge removal



GAS

GAS

SINGLE GAS TORCH

Code: **GT01**

FKC110: heating kit mod. 110 - lever regulation / burner

Ø 50 mm + 5 m rubber hose and keys .

Neck size: 350 mm

Burner: Ø50 mm

Power: 43 kW



SELF IGNITION TORCH

Code: **GT05**

PIEZOELECTRIC IGNITION

rubber hose included

Total length: 700 mm

Ø burner: 60 mm TURBO SPECIAL

POWER: 80kW / Test pressure: 3 BA

DOUBLE GAS TORCH

Code: **GT02**

FK960: double heating kit mod. 960 - lever regulation / 2 TURBO burner Ø 60 mm + 5 m rubber hose and keys .

Neck size: 600 mm

Burner: Ø60 mm TURBO

Power: 75 kW



PLUMBERS GAS TORCH C/W 2MTR HOSE

Code: **GT03**

A perfect soft soldering and brazing torch kit ideal for plumbers perfect for electrical work, gas installation central heating installation tube bending

GAS

GAS

2 MTR HOSE WITH FITTINGS

Code: **GT04**

Gas hose for butane and propane
Fitted 3/8 inch (10 mm) brass connectors with female left-hand thread
Maximum pressure 20 bar
Durable mesh-reinforced rubber gas hose
Length of pipe: 2m, Diameter of the nozzle: 2 cm, Diameter for the pipe: 1.5 cm



Code: **GT04A**

• 5 MTR GAS HOSE WITH FITTINGScm, Diameter for the pipe: 1.5 cm

FLASH BACK ARRESTERS

Code: **PFBA1P**

FOR USE WITH REGULATOR

Code: **PFBA1LP**

REGULAR FIT
FOR USE WITH HOSE



HIGH PRESSURE HOSE

Code: **FA144**

100 METERS RUBBER HOSE, NO CONNECTIONS



GAS

GAS

PLUMBING



SEWER RODS AND ACCESSORIES

CODE	DESCRIPTION	PRICE EACH
S41011	4" PLUNGER	
S41021	6" PLUNGER	
S42011	DOUBLE WORM SCREW	
S44011	4" DROP SCRAPER	
S53031	8" PVC BRUSH	
H11311	3' HOROBIN SEWER ROD	
S11312	DRAIN ROD SET	
S44071	Drain Rod Set & Carrier	



TEST PLUGS

CODE	DESCRIPTION	PRICE EACH
S73061	4 X ½ STEEL TEST PLUG	
S73091	6 x 1 STEEL TEST PLUG	
S73551	8 X 1 STEEL TEST PLUG	
S73552	225MM DRAIN TEXT PLUG	



MANHOLE LIFTING KEY (WELDED STEEL, ZINC PLATED)

CODE	DESCRIPTION	PRICE EACH
S91006	6" MAN HOLE LIFTING KEY	
S91012	12" MANHOLE LIFTING KEY	





SAFELINE DRAIN UNBLOCK

CODE	DESCRIPTION	PRICE	BOX QTY
DM01	450G DRAIN CLEANER		4
DM02	1.8KG DRAIN CLEANER		12

AUTOMOTIVE



AUTOMOTIVE

AUTOMOTIVE



**50MM X 10M
5TN RATCHET
WITH 1 HOOK**

CODE: TL639

**50MM X 8M
5TN RATCHET
WITH 1 HOOK**

CODE: TL452



**RATCHET
25MM X 7.5M**

CODE: TL451



**BUNGEE
12MM X 2FT**

CODE:BE1224

12MM X 4FT

CODE:BE1248



SEAL-UP

is the worlds first permanent Cooling System repair product.

If you have a blown head gasket, cracked engine block or leaking radiator, Seal-Up will stop the leak permanently, without the need for any expensive and time consuming labour and spare parts.

SEAL-UP will repair liquid based cooling systems in :

- Motor Cars
- Lorries
- Agricultural Vehicles
- Building Site Plant
- Classic Cars

SEAL-UP fixes leaks in:

- Radiators
- Engine Blocks
- Cylinder Heads
- Water Pumps

THERMOSTEEL

is a unique steel ceramic paste for repairing cracks and holes in metal objects which are exposed to extreme heat and/or open flame. Heat resistant to 1300°C.

With Thermosteel you can do the job of a hot weld repair virtually anywhere and anytime. In addition to this, you will save time and money by avoiding traditional repair bills or worse still, the trouble and cost of arranging a replacement part.

THERMOSTEEL is ideal for use:

- At Work
- At Home
- On Motor Vehicles
- On Boats & Ships
- On the farm
- Withstands up to 1300C

THERMOSTEEL repairs cracks and holes in:

- Exhaust Manifolds
- Silencers
- Catalytic converters
- Flues
- Central heating boilers



CAR-GO-CHEMICAL PRODUCTS

CODE	DESCRIPTION	PRICE (1)	BOX QTY
TSC	Thermo steel Carded And Blister Pack		12
SUB	Seal Up Blister Card		6

AUTOMOTIVE

AUTOMOTIVE



QUICKSTEEL

Can be used to repair leaks, breaks, cracks and holes in:

- Cars; Bikes; Lorries; Caravans; Boats; Mowers;
- Engines; Batteries; Exhausts; Fuel Tanks;
- Machinery; Cookers; Radiators; Pipes; Ponds;
- Tanks; Baths; Sinks; Tiles; Furniture; Tools...

In fact, the list is almost endless.

QUICKSTEEL is easy, safe and simple to use :

- Clean and prepare repair object by sanding the application area.
- Cut off the required amount of Quik Steel.
- Knead the putty thoroughly until it is an even colour and streak free.
- Apply firmly to the repair object
- Wash hands with soap & water
- QuikSteel can be drilled, sawn, milled, ground, filed, tapped, sanded, painted and lacquered once it has cured.

CAR-GO-CHEMICAL PRODUCTS

CODE	DESCRIPTION	PRICE (1)	BOX QTY
6002/24	2oz Quick Steel Tubes		24
6002ad	2oz quick steel display 24		1

NEW TO OUR RANGE!



PRICE
€ 3.24
PER TUBE

FAST STEEL EPOXY PUTTY

is an easy to mix, steel reinforced epoxy putty, which dries 'steel' hard in just 10 minutes. It can be used to 'weld' two steel pipes together, stop leaks in radiators or exhaust pipes, or fill around a tap and can be drilled, tapped, filed, machined, sanded and painted.



ABSORBENT BAG

ABX 10 is a fire retardant, highly absorbent wood fibre which absorbs oil, grease and other liquid spillages. It is lightweight, non-toxic and can be incinerated, saving on costly landfill charges; it is cost-effective when compared to other granule adsorbents.

SPILL SAFETY

CODE	DESCRIPTION	PER BAG
ABX10	ABSORBENT 30LTR BAG	

BLUE ROLL

2Ply Centre feed rolls, paper hand towels,
absorbant, embossed

2ply Blue Embossed Centre Feed Roll. Ideal for use in hotels, care homes, education establishments, workshops and the leisure industry, or for general use around the

Code: **IND2001**

1 – 60 Rolls

60 -120 Rolls

120 plus rolls



2 PLY TOILET ROLL SAFELINE VELVET QUILTED

Code: **IND2002**

ROLL PACK OF 36



BAG OF RAG'S

Industrial, coloured bag of mixed rags. Suitable for general wiping and cleaning

Code: **RAGS**

WEIGHT: 10KG

SOLD IN BAGS OF 6



PAINTING



PAINTING



CODE: SP1000STAND



SPRAY PAINT



CODE	DESCRIPTION	SELLINGPRICE
SP1000	450ML RED GLOSS SPRAY PAINT	
SP1001	450ML BLACK GLOSS SPRAY PAINT	
SP1002	450ML WHITE GLOSS SPRAY PAINT	
SP1005	450ML GREEN GLOSS SPRAY PAINT	
SP1006	450ML BLUE GLOSS SPRAY PAINT	
SP1007	450ML WHITE MATT SPRAY PAINT	
SP1008	450ML BLACK MATT SPRAY PAINT	
SP1014	450ML YELLOW GLOSS SPRAY PAINT	
SP1021	450ML HIGH TEMP BLACK SPRAY PAINT	
SP1028	450ML SILVER ZINC SPRAY PAINT	4.97

BOX QTY 6 UNITS
PER BOX



BUY 9 SETS GET 1 SET FREE

PAINTING



6PC BRUSH SET

EACH

**PLUS 1 FREE
FOR EVERY SET**

2PCS 1.5"



2PCS 2"



1PC 3"



CODE: PSET6PC

SAFELINE RANGE



Code: **WIPES**

*PRO SOLVE Pro-Wipe Tub
Against MRSA, E-COLI And Salmonella. ProSolve Professional Wipes. Powerful anti-bacterial performance. Hard surfaces without water or scrubbing.*

o 110 wipes per tub

The PRO SOLVE brand includes a comprehensive portfolio of professional paints, markers, lubricants, maintenance aerosols and industrial tapes. These high grade products are designed for many industry sectors including agriculture, automotive, construction and engineering.

CTNQTY : 12

Code: **EBWW**

MULTI PURPOSE WONDER WIPES

Multi-Use Wonder Wipes have become the first choice wipe of the nations builders and tradesmen. Specially formulated to clean hands, tools and surfaces from wet and semi-cured paint, sealant, adhesive, bitumen, expanding foam, oil, grease and even silicone. Particularly useful when there is no water on site.

CTNQTY : 6



Code: **FRKT003**

**4" COMPLETE MINI ROLLER KIT,
CONTAINS 1 GLOSS, 1 EMULSION REFILL
TRAY AND FRAME**

CTNQTY : 24



Code: **PSET3H**

9" EMULSION ROLLER & TRAY SET, WITH 3 REFILLS,
FOR USE ON SMOOTH AND SEMI SMOOTH
SURFACES

CTNQTY : 12



Code: **FBS**

GENERAL PURPOSE SPONGE, IDEAL FOR A WIDE
VARIETY OF JOBS AROUND THE HOME – INSIDE
AND OUT



Code: **PSAB**

PREPARATION SPONGE, WITH ABRASIVE PAD FOR
WALLPAPER STRIPPING, PAINT PREPARATION AND
GENERAL CLEANING



Code: **FDS**

DECORATING SPONGE, IDEAL FOR ALL
DECORATING TASKS.

PAINT SHEET

Code: **DS02**

- PLASTIC BACKED COTTON DUST SHEET FOR
- DOUBLE PROTECTION
- COTTON TOP ABSORBS SPILLS
- PLASTIC BACKING PREVENTS SOAK THROUGH
- SIZE: 12' X 9' 3.5M X 2.6M



PAINTING

PAINTING



DUST SHEET

Code: **DS01**

- 100% COTTON TWIL FOR LONG LIFE
- THOUGH & ABSORBS PAINT SCATTER
- WASHABEL & RE-USEABLE
- PROFESSIONAL QUALITY FOR PAINTERS & DECORATORS
- SIZE: 12' X 9' 3.5M X 2.6M



STEEL WOOL IN QTY OF 12

- SW101 0000 (Ultra Fine)
- SW102 000 (Very Fine)
- SW103 00 (Fine)
- SW104 0 (Med)
- SW105 1 (Med)
- SW106 2 (Med)
- SW107 3 (Coarse)
- SW108 4 (Coarse)



PANEL ADHESIVE (GRIPSALL)

CODE	DESCRIPTION	SIZE	PRICE	BOX QTY
SLS04	GREY MULTI PURPOSE SILICONE	350ML		25



HAND HELD FOAM 750ML TIN

Code: **HHF**

Fix & Fill Expanding Foam is a quick setting polyurethane based foam which expands greatly on application and yields up to 50 times original can contents. Can be cut, sawn, plastered and sealed over after approximately one hour. Fills irregular gaps, fixes framework, insulates and sound deadens.



HAND HELD FIRE RATED FOAM 750ML TIN

Code: **HHFFR**

Firefoam B2 Handheld is a quick setting fire rated, one part polyurethane foam in a ready to use hand held canister. Fire resistant for up to 2 hours in certain joint configurations. It expands on application to up to 50 times the can contents and meets the requirements of the test criteria for BS 476 Part 20 plastered and sealed over after approximately one hour. Fills irregular gaps, fixes framework, insulates and sound deadens.



GUN GRADE FOAM 750ML TIN

Code: **GGF**

Gun Grade Expanding Foam is a quick setting polyurethane based foam which expands greatly on application and yields up to 50 times original can contents. Can be cut, sawn, plastered and sealed over after approximately one hour. Fills irregular gaps, fixes framework, insulates and sound deadens. Designed for professional use in conjunction with Gun Foam Applicators. BOX 12



GUN GRADE FIRE RATED FOAM 750ML TIN

Code: **GGFR**

Firefoam B2 Gungrade is a quick setting fire rated, one part polyurethane foam designed for application by any standard foam applicator gun. Fire resistant for up to 2 hours in certain joint configurations. It expands on application to up to 50 times the can contents and meets the requirements of the test criteria for BS476 Part 20. FOR PROFESSIONAL USE ONLY plastered and sealed over after approximately one hour. Fills irregular gaps, fixes framework, insulates and sound deadens.



DUAL PURPOSE FOAM CLEANER 500 ML TIN

Code: **EBDUEFC**

Dual Purpose Foam Cleaner is used to remove wet/uncured foam. Attaches to Gun Foam Applicator for purging through; also includes spray nozzle for use without applicator to remove wet foam from outside of the gun and from most building substrates.



MULTI PURPOSE GREASE 400G

Code: **EP2**

A high quality multipurpose EP2 lithium grease suitable for most grease guns



A revolutionary filler formulated using lightweight polymer bubbles that fills most holes and cracks, even deep holes, in just one quick application with no need for secondary filling to level off as One Strike will not shrink, sag or crack. One Strike Filler finishes smooth, requiring little or no sanding and can be ready to paint in approximately 30 minutes.

ONE STRIKE FILLER

CODE	DESCRIPTION	SIZE	COLOUR	PRICE (1)	BOX QTY
ONE025	ONE STRIKE FILLER	250ML	WHITE		18
ONE05	ONE STRIKE FILLER	500ML	WHITE		12
ONE1	ONE STRIKE FILLER	1LTR	WHITE		6



The Business, is a durable, universal, flexible hybrid sealant and adhesive that sticks and seals anything to anything – it is quite simply The Business!

For both internal and external use, in all weather conditions, with excellent adhesion even on wet surfaces. Quick curing, weather resistant, isocyanate, solvent and acid-free making it safer to use. Remains fully elastic.

Suitable for almost any bonding and sealing applications. Can be applied to: glass, timber, bricks, porcelain, ceramics, polyurethane, GRP, polystyrene, coated metal, epoxy, PVCu, most plastics and much more.

BUSINESS PANEL ADHESIVE

CODE	DESCRIPTION	PRICE
EBX2BUSBK	CRYSTAL BLACK 290ML	
EBX2BUSCL	CRYSTAL CLEAR 290ML	
EBX2BUSGY	GREY 290ML	
EBX2BUSWE	CRYSTAL WHITE 290ML	

APPLICATION GUNS

STANDARD SILICONE GUN ORANGE

For the application of Caulk/Silicone/Mastic.

Code: **MG300**

Size: **400ML**



BLACK GUN C/W RED PVC COATED HANDLE

Code: **MG400**

Size: **325mg**



FOAM APPLICATOR GUN C/W BLACK HANDLE BOXED

PU FOAM GUN BL EVERBUILD PRODUCTS EB

For the application of 1C Gun Foam.

Code: **MG028**

Size: **N/A**

Box Qty: **12**

Code: **89457EB**

Size: **N/A**

Box Qty: **12**

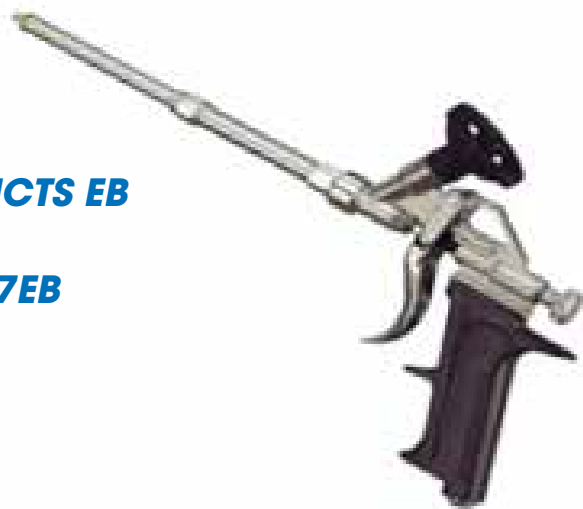

PAINTING

PAINTING

CARTRIDGE DISPENSING GUN NEW EVERBUILD PRODUCTS EB

For 310ml cartridges.

Code: **89455**

Size: **310ML**

Box Qty: **12**

Code: **EB89455**

Size: **310ML**

Box Qty: **12**



COX TYPE PROFESSIONAL MASTIC GUN

For 300 – 600 ml cartridges. The Combi Barrel gun is designed for use with foil packs, the enclosed aluminium barrel can also be used for standard cartridges.

Code: **89458**

Adapter for 400ml sausages.

Size: **300- 600ML**

Box Qty: **6**



TUBE FOAM GUN

Code: **MG111**



FOAM APPLICATOR GUN C/W BLUE HANDLE

Code: **MG001**





APPLICATIONS: IS SPECIALLY INTENDED TO PRODUCE SEALING AND BONDING JOINTS IN TECHNICAL AND INDUSTRIAL AREAS SUCH AS:

- CONTROLLED ENVIRONMENT ROOMS (REFRIGERATED ROOMS, CLEAN ROOMS ETC)
- SALTING, CHEESE AND DAIRY PRODUCERS
- IT ALSO HAS MANY SEALING APPLICATIONS SUCH AS PRODUCING.
- JOINTS FOR BATHTUBS, SINKS SHOWERS, KITCHEN SINKS, KITCHEN FURNITURE.
- JOINTS AROUND TILES, PLUMBING ETC

SANITARY HPS

CODE	COLOUR	SIZE	PRICE	BOX QTY
EVT11351	WHITE	310ML		25
EVT11341	TRANSPARENT	310ML		25
EVT11231	MIDGREY	310ML		25
EVT11211	MANHATTAN	310ML		25
EVT11151	DUSTGREY	310ML		25
EVT11271	PERGAMON	310ML		25
EVT11191	JASMINE	310ML		25
EVT1161	BLACK	310ML		25



APPLICATIONS: CAN BE USED ON ALL WEATHER PROOFING OR BONDING APPLICATIONS WHERE PROTECTION AGAINST FUNGAL GROWTH IS SOUGHT, SUCH AS:

- JOINTING BATHS, SINKS, SHOWERS, KITCHEN FURNITURE, URINALS.
- JOINTING CERAMIC TILES, PLUMBING FIXTURES OR COLD ROOMS.

SANITARY HPS

CODE	COLOUR	SIZE	PRICE	BOX QTY
EVT12351	WHITE	310ml		25
EVT12341	TRANSPARENT	310ML		25

CONNECTION JOINT HPA CLEAN ROOM

CODE	COLOUR	SIZE	PRICE	BOX QTY
EVT15351	WHITE	310ML		20
EVT15131	CONCRETE GREY	310ML		20

NATURAL STONE HPM NON STAINING

EVT16351	WHITE	310ML		20
EVT16191	JASMINE	310ML		20
EVT1661	BLACK	310ML		20
EVT1651	BEIGE	310ML		20
EVT16171	GREY	310ML		20
EVT16341	CLEAR	310ML		20
EVT16271	PERGAMON	310ML		20
EVT1611	ANTHRACITE	310ML		20
EVT16181	GREY/WHITE	310ML		20
EVT16231	MID GREY	310ML		20

CONSTRUCTION HPC

EVT1714	ANTRACITE	380ML		25
EVT17384	BRICK RED	380ML		25
EVT17394	BUFF	380ML		25
EVT17171	GREY	310ML		25
EVT17174	GREY	380ML		25
EVT17401	LIGHTGREY	310ML		25
EVT17411	OFFWHITE	310ML		15
EVT17424	PORTLAND	380ML		25
EVT17431	TEAK	310ML		25
EVT17434	TEAK	380ML		25
EVT17341	TRANS	310ML		25
EVT17354	WHITE	380ML		25
EVT17353	WHITE	310ML		25
EVT1761	BLACK	310ML		25
EVT1764	BLACK	380ML		25
EVT17441	BRONZE	310ML		25



APPLICATIONS: THIS IS SPECIALLY INTENDED TO PRODUCE SEALING AND BONDING JOINTS IN THE CONSTRUCTION AND GLAZING INDUSTRIES, NOTABLY FOR:

- TRADITIONAL CONSTRUCTION (EXPANSION AND STABILITY JOINTS)
- LIGHT PREFABRICATION (CURTAIN WALLS, METAL COVING)
- FLOORING JOINTS (CONCRETE SLABS, MOTORWAYS, RUNWAY'S)
- CARAVAN JOINTS
- BONDING OF DECORATIVE PANELS
- PERIMETER SEALS IN ALUMINIUM, WOODEN, PVC FRAMES, ETC.
- ELASTIC SEALS IN GLAZING APPLICATIONS, ON ALUMINIUM, WOODEN PVC FRAMES ETC.
- HEAVY PREFABRICATION (TERRACE, PARAPET WALL AND FAÇADE PANEL JOINTS)
- VENTILATION DUCTS, PIPING PASSAGES, GUTTERING AND DOWN PIPES.
- BONDING OF MATERIALS TO VIBRATIONS

**AREAS OF APPLICATION:**

EVT 007 HPHA is used for miscellaneous bonding and the sealing of seams and joints in the construction of buildings (including glass and mirror assemblies, the latter in accordance with DIN regulation 1238), vehicles, train wagons and ships, as well as in mechanical, electrical and ventilation engineering and air conditioning technology. It may also be used on floor joints. Depending on the stability of the surface, EVT HPHA 007 is suitable for interior and exterior use; it may be used on damp surfaces. HPHA 007 creates elastic bonding between concrete, stone and brickwork, metals, plastics, wood, ceramics and marble

**EQUIVALENT
TO TEC 7**

HYBRID ADHESIVE 007 HPHA

CODE	COLOUR	SIZE	PRICE	BOX QTY
EVT53351	WHITE	290ML		25
EVT53171	GREY	290ML		25
EVT53361	BLACK	290ML		25

**APPLICATIONS: THIS IS SUITABLE FOR WEATHER - SEALING AND BONDING SEALS FOR CONSTRUCTION AND GLAZING APPLICATIONS.**

- CURTAIN WALLS, FAÇADE PANELS, METALIC AND PVC JOINERY
- BONDING MIRRORS AND GLAZING WINDOW JOINTS ON ALUMINIUM, WOOD, PVC ETC

WINDOW 70

CODE	COLOUR	SIZE	PRICE	BOX QTY
EVT19351	WHITE	310ML		25
EVT19341	TRANS	310ML		25
EVT19491	LIGHT OAK	310ML		25
EVT19171	GREY	310ML		25
EVT19361	CHARTWELL CLEAR	310ML		25
EVT1981	BRIGHT BROWN	310ML		25
EVT19451	SHERWOOD	310ML		25
EVT19481	DARK BROWN	310ML		25



APPLICATIONS: IS A GENERAL PURPOSE, PAINTABLE SEALANT FOR INTERIOR AND EXTERIOR BONDING, SEALING AND JOINTING.

- HEAVY AND LIGHT CONSTRUCTION, CARPENTRY, ROOF TILING, MARINE
- TRADITIONAL MASONRY, INTERIOR DECORATING, METALLIC CONSTRUCTION
- AUTOMOTIVE.

CRYSTAL CLEAR HPC

CODE	COLOUR	SIZE	PRICE	BOX QTY
EVT24351	WHITE	290ML		25

POLYURETHANE SEALANT (SAUSAGE)

CODE	COLOUR	SIZE	PRICE	BOX QTY
EVT22599100531	CONCRETE GREY	600ML		20



COLOURS AVAILABLE: White, Black, Mid Grey, Brick Red, Brown, Buff, Anthracite, Magnolia, Portland Stone, Limestone White.

Everbuild silicone 825 is a low modulus, neutral cure, alcoxy, odourless silicone sealant that adheres to a wide range of both porous and non porous surfaces without the need for priming. Conforms to the requirement of 11600 F+G.

SPECIFICATION COMPLIANCES

Conforms to ISO11600 F 25LM. (Report number RLR.10+11)

BENEFITS

- Excellent tooling and slow skinning properties for large scale construction and glazing applications.
- Excellent adhesion - adheres to most common surfaces including glass, metals, plastics and wood (painted or unpainted), uPVC and polycarbonate.
- Excellent external weathering properties (over many years exposure).
- High viscosity non slump formula.

EVERBUILD 825 SILICONE

CODE	COLOUR	SIZE	PRICE	BOX QTY
EB825ANTH	ANTRACITE	380ML		25
EB825BLK	BLACK	380ML		25
EB825BRIRED	BRICK RED	380ML		25
EB825BRW	BROWN	380ML		25
EB825BUFF	BUFF	380ML		25
EB825DGREY	DARK GREY	380ML		15
EB825LWHE	LIMESTONE WHITE	380ML		25
EB825MAGN	MAGNOLIA	380ML		25
EB825MGREY	MID GREY	380ML		25
EB825PORT	PORTLAND STONE	380ML		25
EB825WHE	WHITE	380ML		25



Anti-Pick 109 is a high modulus, one part, chemically curing solvent free sealant combining the best qualities of silicone and polyurethane technologies. It is specifically designed for providing a finger pick resistant seal accommodating small movement for areas where a normal sealant is not hard enough.

BENEFITS:

Excellent impact and wear resistance. Resistant to picking by fingers. Excellent primerless adhesion to most surfaces, including metals, most plastics, glass, polyester. High UV and aggressive atmosphere resistance. Excellent resistance to Chemicals & petrol (10% dilute acids, alkalis, most solvent). Overpaintable with certain paints (compatibility test should be made). Can be applied on damp surfaces. Non hazardous to health. High mechanical properties. Passed for use on different home office, national offender management services and ministry of justice projects

RECOMMENDED FOR:

Secure environments i.e. prisons & hospitals where the sealant is hard to reach or the person is under supervision. Municipal and public areas. Perimeter sealing of doors, windows and sanitary ware. Joints in heavy cladding.

EVERBUILD 109 ANTI PICK

CODE	COLOUR	SIZE	PRICE	BOX QTY
EBANTI PICK	WHITE	310ML		25
EBANTI PICK1	GREY	310ML		25
EBANTI PICK2	SOFT LINEN	310ML		25



Circular closed cell polyethylene foam cord in 10mm, 15mm, 20mm & 30mm thickness.

QUANTITY: 1150 metre roll.

Non absorbent compressible grey closed cell polyethylene foam backup material.

FEATURES

- Quick and easy to apply.
- Reduces sealant usage.
- Improves sealant performance by obtaining the correct joint dimensions.
- Flexible - won't bubble or blister.

RECOMMENDED FOR:

- Reducing the depth of joints in construction and glazing use.
- Creating a backstop to allow proper sealant tooling in expansion joints.

EVERBUILD POLYETHYLENE FOAM BACKER ROD

CODE	SIZE	PRICE	BOX QTY
EBBACK10	10MM x 1150 METRE		1
EBBACK13	13MM x 750 METRE		1
EBBACK15	15MM X 550 METRE		1
EBBACK19	19MM X 350 METRE		1
EBBACK20	20MM X 350 METRE		1
EBBACK25	25MM x 200 METRE		1
EBBACK 30	30MM X 160 METRE		1
EVT9102891	50.0MM x 90 METRE		1
EVT921715	20MM X 150 METRE		1
EVT921717	25MM X 100 METRE		1
EVT921722	30MM X 80 METRE		1
EVT921728	40MM X 120 METRE		1
EVT92177	6.00MM 100 METRE		1
EVT92178	8.00MM X 100 METRE		1
EVT92179	10.0MM X 100 METRE		1
EVT921736	13MM X 100 METRE		1

DESCRIPTION

FIRE SEALANT 400 is a neutral cure, elastic silicone sealant which has a fire rating of up to 4 hours in certain joint configurations (when tested to BS EN 1366-4 2006).

BENIFITS

Fire rated to BS EN 1366-4 2006

Neutral cure – adheres to most building surfaces, porous and non porous

Permanently flexible (25% movement accommodation)

Excellent weathering characteristics – suitable for internal and external use.

Can be used in joints up to 50mm wide.

No priming required for most construction substrates

Non slump – easy to apply and tool off

Forms an acoustic seal

RECOMMENDED FOR

All building joints which require a fire rating.

Sealing joints, voids and irregular holes in fire walls, partitions and other structures; also for maintaining the integrity of pipes and cables that penetrate them. Ideal for use for fire rated expansion joints.

**EVERBUILD FIRE SEALANT**

CODE	COLOUR	SIZE	PRICE	BOX QTY
EB32141010	WHITE	380ML		25
EBF400BLK	BLACK	380ML		25
EBF400GREY	GREY	380ML		25



FIRE MATE SEALANT is an intumescent acrylic sealant that swells when exposed to temperatures in excess of 125°C to prevent the passage of fire and smoke and has a fire rating of up to 5 hours in certain joint configurations. Fire rated to BS 476 Part 20/EN1366-4 (2006). Acoustic rates to BS EN ISO 140/3. Tested for air permeability to EN13141-1.

EVERBUILD FIRE MATE

CODE	COLOUR	SIZE	PRICE	BOX QTY
EBFIREMATE	WHITE	310ML		25
EBFIREMATE 1	GREY	310ML		25

FIRE SEALANT 300 is an intumescent and acoustic acrylic sealant that swells when exposed to temperatures in excess of 150°C to prevent the passage of fire and smoke and has a fire rating of up to 5 hours, Fire rated to BS 476 part 20/EN1366-4 (2006). Typically used for sealing joints, voids and irregular holes in fire walls, partitions and other structures; also for maintaining the integrity of pipes and cables that penetrate them. For internal perimeter pointing of fire rated door and window frames. Acoustic rated to BS EN ISO 140/3. Tested for air permeability to EN13141-1 Ventilation fo buildings. Performance testing of components/ products for residential ventilation.

EVERBUILD FIRESEAL 300 / 400

CODE	COLOUR	SIZE	PRICE	BOX QTY
EBFIRESEAL300	WHITE	380ML		25
EBFIRESEAL300G	GREY	380ML		25





DESCRIPTION

FOREVER SAFE SILICONE is guaranteed to kill most common germs on the surface of the sealant including E-Coli, MRSA, Salmonella, Listeria, Staphylococcus, to stop Black Mould and is safe for use in Food Preparation areas. The antibacterial technology used has EU Food Contact Approval.

SPECIFICATION COMPLIANCES

Forever Safe is independently tested and certified by an accredited microbiological laboratory to show no mould growth after more than 10 yrs simulated ageing. Copies of test data are available upon request. Forever Safe is formulated using a premium quality permanently flexible waterproof 100% Silicone Sealant. Forever Safe is also formulated using an FDA approved Silicone Sealant with FDA approved fungicide.

BENEFITS

- Kills MRSA, E-Coli, Listeria, salmonella and Staphylococcus.
- FDA approved for food contact. For sealing in commercial kitchens and bathroom areas, Medical
- 10 year mould guarantee.
- Excellent flexibility - +/- 25%.

RECOMMENDED FOR

Pharmaceutical clean rooms, Hospitals, operating theatres and clinics and refrigerated food storage areas. Also, ideal sealing domestic kitchen worktops and food areas and communal shower areas.

EVERBUILD FIRESAFE SILICONE

CODE	COLOUR	SIZE	PRICE	BOX QTY
EBFOREVERS	WHITE	310ML		25

EVERBUILD'S STIXALL. EXTREME POWER!!

Based upon new Hybrid PMS Polymer technology is the "ultimate combined building adhesive and sealant", with the power to both bond and seal virtually everything to anything.

It's Water resistant, and can be applied to wet and damp surfaces, making Stixall perfect for snag lists. It's raining is now not an excuse. With this product working in the wet and damp is made possible and easy.

EVERBUILD STIXALL

CODE	COLOUR	SIZE	PRICE	BOX QTY
EBSTIXBN	BROWN	300ML		12



A mid modulus sanitary & shower silicone sealant that adheres to most smooth and non-porous materials. Contains a powerful anti-fungal compound to prevent mould growth in areas of high humidity. Forms a permanently flexible rubber seal.

EVERBUILD SHOWERPROOF

CODE	COLOUR	SIZE	PRICE	BOX QTY
EBSHOWERPROOFCLEAR	CLEAR	310ML		25
EBSHOWERPROOFWHITE	WHITE	310ML		25

SILICONE S50 is a mid modulus, heavy bodied acetoxy curing silicone sealant that contains a powerful anti-fungal compound to prevent mould and fungal growth in areas of high humidity. The mid modulus nature of this formulation gives improved adhesion and flexibility when compared to standard high modulus sanitary grades. Tested to ISO8339 and ISO10590/10563.

EVERBUILD S50 SANITARY

CODE	COLOUR	SIZE	PRICE	BOX QTY
EBS50WHE	S50 WHITE	310ML		25



EVERBUILD SIKAFLEX PRO3

CODE	COLOUR	SIZE	PRICE	BOX QTY
EBSIKAPR03GREY	GREY FOIL	600CC		12
EBSIKPRO3WHE	WHITE FOIL	600CC		12

SIKAFLEX® PRO-3 is a multipurpose floor joint sealant suitable for Movement and connection joints in floors Indoor and outdoor applications for pedestrian and traffic areas (e. g. parking decks, car parks) In warehouses and production areas, On surfaces such as in the food industry, In ceramic tiles such as in public buildings etc., Joints in waste water and sewage treatment plants, Floor joints in tunnel construction, Application in clean rooms.



EVERBUILD WEATHERMATE

CODE	COLOUR	SIZE	PRICE	BOX QTY
EBWEATHER	BLACK	310ML		25
EBWEATHERWHITE	WHITE	310ML		25

WEATHER MATE is a multi-use adhesive and gap filler based on an advanced isocrylic formula that provides the ultimate in weather proofing technology for adhesion to all surfaces. The product can be applied in wet weather, and will even stick to wet surfaces. Adheres to many problematic surfaces such as bitumen, lead, galvanised steel and roofing felts.



EVERBUILD GENERAL PURPOSE

CODE	COLOUR	SIZE	PRICE	BOX QTY
EBSPG	GREY	310		25
EBSPSBN	BROWN	310ML		25

GENERAL PURPOSE SILICONE is a mid modulus silicone sealant that adheres to most smooth and non-porous materials. Contains an anti-fungal compound to prevent mould growth in areas of high humidity. Forms a permanently flexible rubber seal.





Multi-Purpose Wood Filler fills nail holes, cracks, gaps and minor imperfections in wood. It is easy to sand and can be stained, varnished and painted and is solvent free

EVERBUILD MULTI PURPOSE WOOD FILLER

CODE	COLOUR	SIZE	PRICE	BOX QTY
EBMPWOODPINE	MP WOOD FILLER PINE	250ml		6
EBMPWOOD MAHOGANY	MP WOOD FILLER MAHOGANY	250ml		6
EPWOODMED2	MP WOOD MEDIUM STAIN FILLER	250ml		6
EBMPWOODLOAK	MP WOOD FILLER LIGHT OAK	250ml		6
EBMPWOODWHITE	MP WOOD FILLER WHITE	250ml		6

EVERBUILD EXTRAS

CODE	COLOUR	SIZE	PRICE	BOX QTY
EB200CL	CLEAR 200	310ML		25
EB225	HIGH MOD SILICONE BRUSHED STEEL	310ML		25
EB335WHE	335 SILICONE WHITE	310ML		25
EB500W	500 WHITE SILICONE	310ML		25
EB502WOODADHESIVE	502 WOOD ADHESIVE	1LTR		12
EB700TWHE	700T WHITE	310ML		25
EBCR565WHE	565 CLEAN ROOM WHITE	310ML		25
EBGUNANAIL	PANEL ADHESIVE	380ML		25
EBGUNF	GUN FOAM CLEANER	500ML		25
EBHEATMATE	HIGH TEMP SILICONE RED	310ML		25
EBHM60WHE	HM60 WHITE	310ML		25
EBHYBRIFLEX480	PAINTABLE SILICONE WHITE	380ML		25
EBLEADGREY	LEAD MATE GREY	310ML		25
EBMITREFAST	MITRE FAST KIT 2 PART			12
EBHEATMATEBK	HIGH TEMP BLACK			12

TRAFFIC & ROPE



EASY MARK PAINT

CODE	COLOUR	PER TIN	BOX QTY
SPY	YELLOW		12
SPW	WHITE		12
SPR	RED		12
SPG	GREEN		12
SPB	BLUE		12
SPBK	BLACK		12
SPO	ORANGE		12



TEMPORARY LINE MARKING PAINT

CODE	COLOUR	PER TIN	BOX QTY
STEMPR	RED		6
STEMPY	YELLOW		6
STEMPW	WHITE		6
STEMPB	BLUE		6



PAINT APPLICATORS

CODE	DESCRIPTION	PER
MLMTA	4 WHEEL PAINT APPLICATOR TROLLEY	
MLMT2	2 WHEEL	
MLMTAADAPTOR	2/4 WHEEL ADAPTOR	



HAND PAINT APPLICATORS

CODE	DESCRIPTION	PRICE
mlmthand	HAND HELD PAINT APPLICATOR	

NYLON LINE REEL DISPLAY

CODE	DESCRIPTION	PK	PER 24
TL321	270 X 82M	24	



TRAFFIC & ROPE

TRAFFIC & ROPE



BUILDERS BUCKETS

CODE	DESCRIPTION	PER 1
RB02	3 GAL (12 LITRE)	

TRAFFIC
& ROPETRAFFIC
& ROPE

HEAVY DUTY & FLEXIBLE BUILDER TUB (BLACK)



SOLD IN 12'S ONLY

CODE: RB05

CODE: RB06

26LTR

42LTR



ROPE

Code	Description	PRICE PER 1	BOX QTY
BC630	6.0 X30METRES POLYPROP BLUE ROPE		20
BC830	8.0 X30METRES POLYPROP BLUE ROPE		20
BC1030	10.0 X30METRES POLYPROP BLUE ROPE		10
BC1230	12.0 X30METRES POLYPROP BLUE ROPE		8
PVCCL	CLOTHES LINE 5.0MM X 20 PVC C/W WIRE CORE		20
BL18	1/2 KG ORANGE BUILDERS LINE		12
BL33	1/2 KG ORANGE BUILDERS LINE		20
BC915MP	9.0 X15METRES BRAIDED PP ROPE		20
WML	WHITE NYLON LINE		24
STL	COTTON TWINE 1.0MM X 200 GRAMS		20
BC40HR	4.0MM X 15 METRE POLYPROPYLENE ROPE HANDIREEL		40
BC60HR	6.0MM X 15 METRE POLYPROPYLENE ROPE HANDIREEL		40
BC80HR	8.0MM X 15 METRE POLYPROPYLENE ROPE HANDIREEL		20



POLYPROPYLENE BLUE ROPE ON REEL

CODE	SIZE	PER ROLL
BR60	6.0MM	
BR80	8.0MM	
BR100	10.0MM	
BR120	12.0MM	

TRAFFIC
& ROPE

POLYPROPYLENE BLUE ROPE ON COIL

CODE	SIZE	PER ROLL
BC60	6.0 MM	
BC80	8.0 MM	
BC100	10.0 MM	
BC120	12.0MM	
BC140	14.0 MM	
BC160	16.0 MM	
BC180	18.00MM	
BC200	20.00MM	



ROAD PRODUCTS

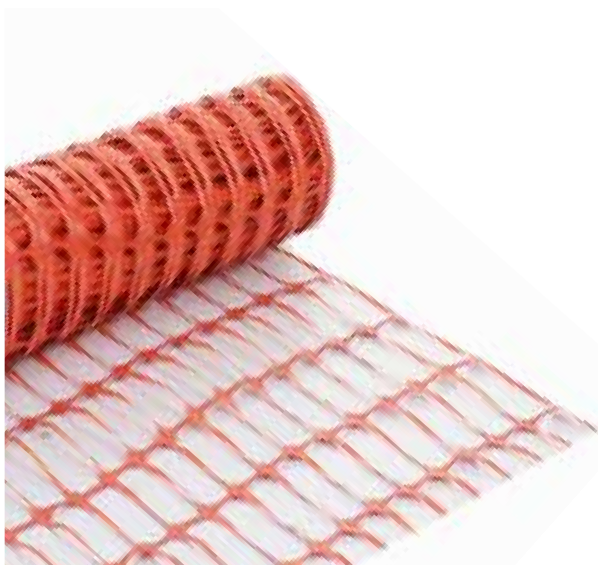

BARRIER FENCING 50 MTR X 1 MTR

CODE	DESCRIPTION	PRICE
JS5017	Orange Barrier Fencing	

GREEN DEBRIS NETTING

CODE	DESCRIPTION	PRICE
JS5016	2M X 50M	



JSP ROAD CONES

CODE	DESCRIPTION	PRICE
JS0902	75CM ROADHOG CONE 1 PC	
JS1901	50CM SAND BASE ROAD CONE	
JS9902	1M DOMINATOR ROAD CONE + SEALBRITE SLVE	
JS9903	1M DOMINATOR ROAD CONE SEALBRITE SLEEVE	



TRAFFIC & ROPE

TRAFFIC & ROPE

ROAD PRODUCTS

TRAFFIC
& ROPETRAFFIC
& ROPE

- Powerful twin battery lamp, 360° degrees swivel head for all round light visibility, 180mm diameter lens area for maximum light output. Tamper proof zinc plated security bolt allows product to be secured to barriers, cone barriers and scaffold brackets.
- Wide retro-reflectivity prismatic lens surround
- Impact resistant lens, moulded in premium quality polycarbonate
- Conforms to BS3143 Part 2

MAXILITE

CODE	DESCRIPTION	PRICE
JS4042	MAXILITE INTENSITY FNPC	

BATTERY

CODE	DESCRIPTION	PRICE
JS7019	MAXILITE BATTERY	

MAXLITE BRACKET FOR CONES

CODE	DESCRIPTION	PRICE
JS4042A	MAXILITE BRACKET CONES	

LADDERS



ROOFING HEIGHT LADDER

- For indoor and outdoor use
- EN 131-2



4.69M

3.15M

2.00M



FIBREGLASS PLATFORM LADDER



**EXTRA STRONG
PLATFORM**



**INCLUDES AND COMES
COMPLETE WITH
EXTRA FRP STABILIZERS**

**EXTRA STRONG
RUBBER FEET**

	FIB4L	FIB6L	FIB8L
	3 TREADS + PLATFORM	5 TREADS + PLATFORM	7 TREADS + PLATFORM
TOTAL HEIGHT (OPEN)	175CM	261CM	318CM
PLATFORM HEIGHT	109CM	166CM	223CM

FIBREGLASS PLATFORM LADDER



FIB10P MUST BE BOUGHT IN 2'S



TOOL TRAY
KEEPS YOUR TOOLS ACCESSIBLE



WIDE PLATFORM AREA
PROVIDES ENHANCED STABILITY FOR WORKING



NON CONDUCTIVE
SUITABLE FOR WORKING AROUND ELECTRICS

OPEN MEASUREMENTS

CODE	WIDTH (mm)	HEIGHT (mm)	LENGTH (mm)
FIB4P	495	1565	950
FIB6P	550	2030	1295
FIB8P	610	2500	1630
FIB10P	665	2970	1955

FIBREGLASS LADDERS RANGE

Includes Tools Tray ↘

FIB8

FIB6

Heavy Duty Profile ↘

Heavy Duty Rivets ↗



FIB4

**30,000 V INSULATION
MAX LOAD: 150KG**

**STANDARD
BSEN131**

LADDERS

LADDERS

FIBREGLASS LADDER

CODE	DESCRIPTION	PK QTY.	PRICE
FIB4	3 + 1 STEP THREAD	2	
FIB6	5 + 1 STEP THREAD	2	
FIB8	7 + 1 STEP THREAD	2	

EXTENDABLE SCAFFOLD LADDER

CODE: FESCAF

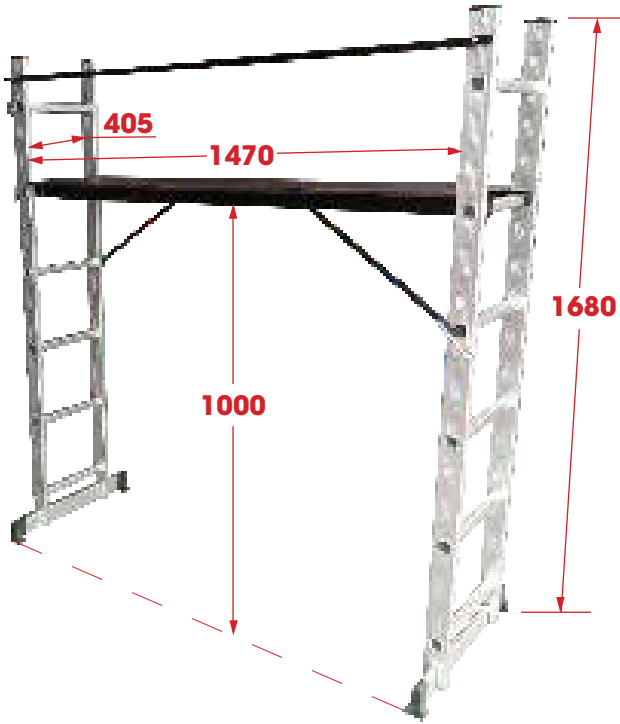

- ✓ EXTENSION LENGTH 282CM
- ✓ MATERIAL: ALUMINIUM
- ✓ THICKNESS: 1.2MM
- ✓ SPACE BETWEEN RUNGS: 28CM
- ✓ TOTAL LEVELS 12
- ✓ MAX LOAD: 150kgs
- ✓ TUV Tested
- ✓ 15.8 kg

LADDERS

LADDERS

EXTENDABLE SCAFFOLD LADDER

CODE	DESCRIPTION	PK QTY.	PRICE
FESCAF	2X6	1	

ROOFING LADDER

- For indoor and outdoor use
- EN 131-2

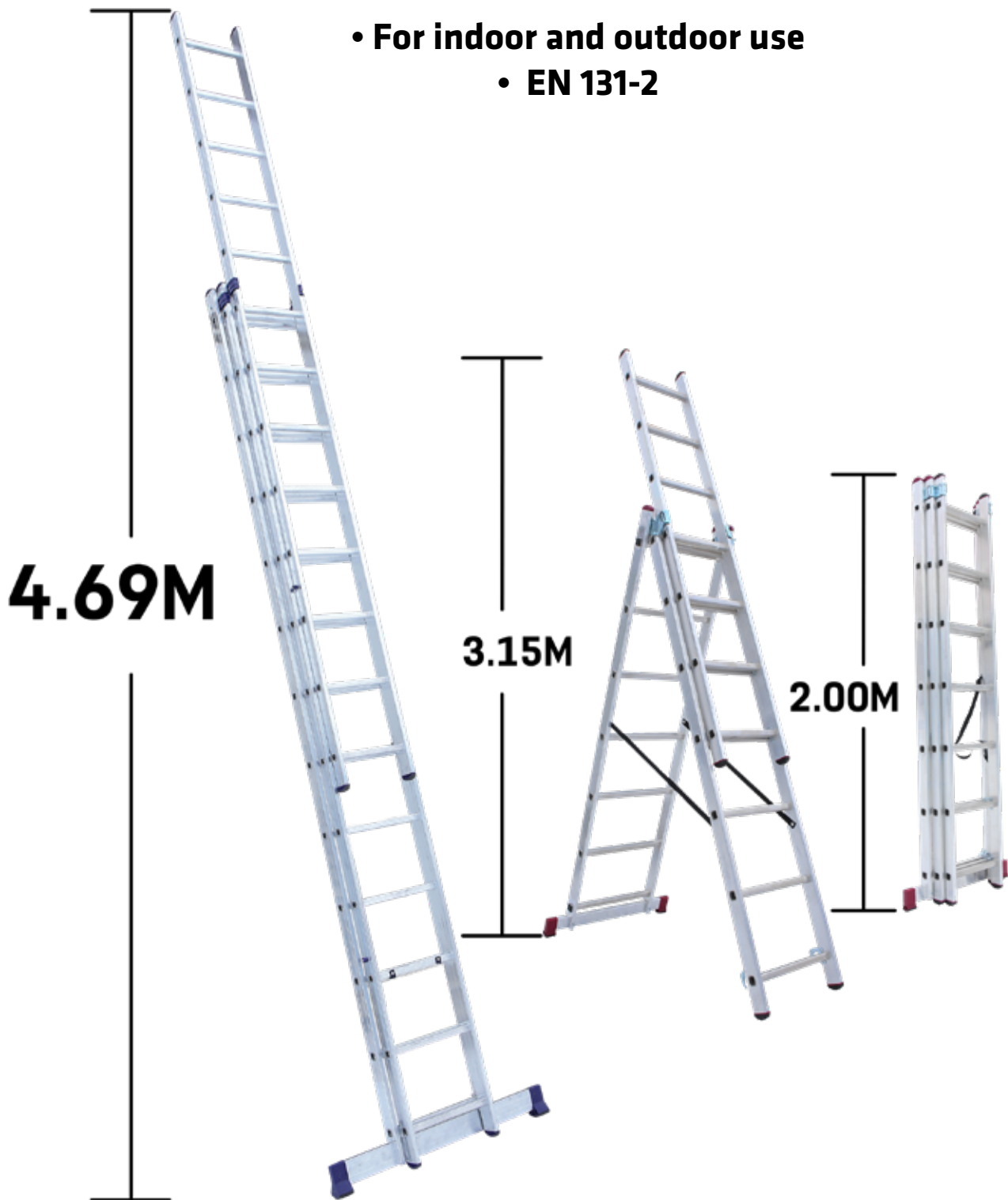

LADDERS

LADDERS

ROOF LADDER

CODE	DESCRIPTION	PK QTY.	PRICE
FE3X7	200 X 46 X 16CM	1	

COMBI LADDER

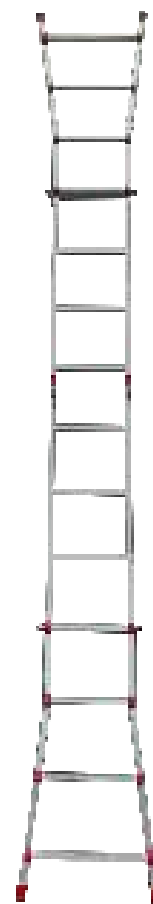

LADDERS

LADDERS

CODE: FEB4X4

CODE: FEB4X5

	WIDTH (CM)	HEIGHT (CM)	LENGTH (CM)
A 	54.5cm	119cm	22cm
B ^	54.5cm	113.5cm	61.5cm
C ^	54.5cm	192cm	137cm
D 	54.5cm	386cm	9cm

	WIDTH (CM)	HEIGHT (CM)	LENGTH (CM)
A 	61.5cm	146.5cm	23cm
B ^	61.5cm	140cm	97cm
C ^	61.5cm	218.5cm	154cm
D 	61.5cm	452cm	9cm

COMBI LADDER			
CODE	DESCRIPTION	PK QTY.	PRICE
FEB4X4	4X4	1	
FEB4X5	4X5	1	

FOLDING WORK PLATFORM

CODE: FEP

LADDERS

LADDERS



HEIGHT

490MM

SIZE

760MM X 300MM

MAX WEIGHT LOAD

150kg

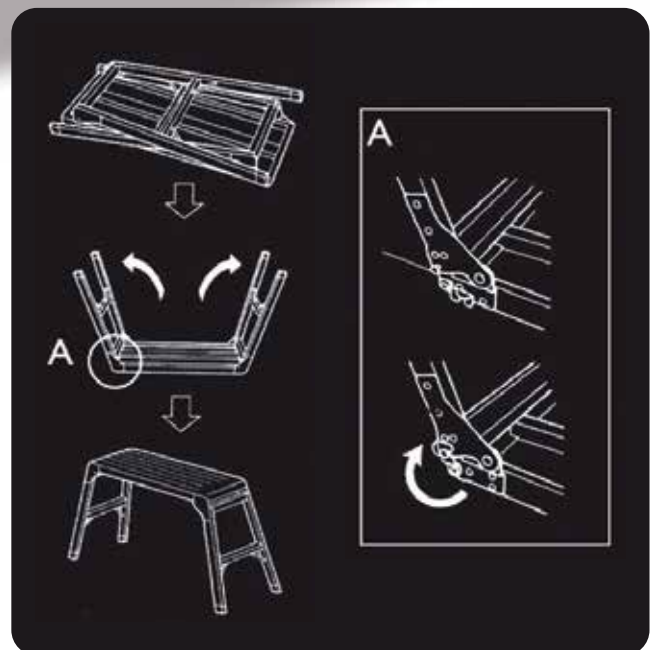

ALUMINIUM WORK PLATFORM

**EXTRA WIDE
PLATFORM**



CODE:FEP2



ALUMINIUM WORK PLATFORM

EXTRA LONG PLATFORM



95CM

30CM

49CM



ANTI SLIP PLATE



QUICK RELEASE LEGS

CODE:FEP3

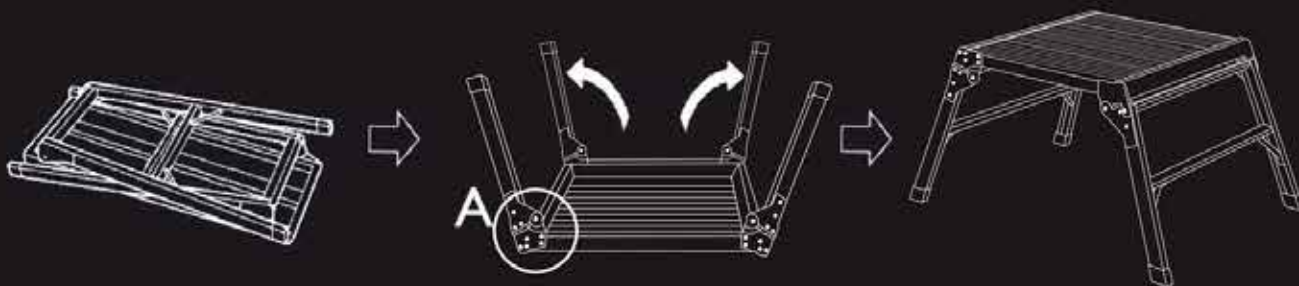

LADDERS



LADDERS

LADDERS

EN131

HEAVY DUTY STEP LADDERS

CODE	DESCRIPTION	PRICE	PK QTY
SL02	2 STEP		4
SL03	3 STEP		4
SL04	4 STEP		4
SL05	5 STEP		4

LADDERS



LADDERS

LADDERS

A FRAME ALUMINIUM LADDER

- ✓ WIDE EXTRUDED STEPS FOR SURE FOOTED SAFETY
- ✓ MAX LOAD :150KG
- ✓ STORES ANY PLACE
- ✓ HANGS FLAT
- ✓ EN STANDARD

HEAVY DUTY A FRAME STEP LADDERS

CODE	DESCRIPTION	PRICE	PK QTY
FE2	2 STEP		2
FE3	3 STEP		2
FE4	4 STEP		2
FE5	5 STEP		2

MULTI PURPOSE LADDER



LADDERS

LADDERS

- ✓ GS & EN131 Certified
- ✓ Made to with-stand industrial use
- ✓ Perfect for both tradesmen or the DIY
- ✓ Heavy duty construction
- ✓ Different positions makes this ladder the most versatile Ladder on the market, will allow you to reach any job with ease.
- ✓ Can be used as a working platform
Useful folding design allows ladder to be stored in small spaces

- ✓ Light weight: 13.9 Kg
- ✓ Max Load: 150 Kg
- ✓ Open Height: 355 cm
- ✓ Step ladder Height: 174 cm
- ✓ Platform Span: 228 cm
- ✓ Platform Height: 96 cm
- ✓ Pack size: 97 x 37 x 28 cm

MULTI PURPOSE LADDER

CODE	DESCRIPTION	PRICE
FE4X3	12FT 6 HINGE LADDER	
FE4X4	16FT 6 HINGE LADDER	
FE4X3E	3.5 M MULTIPURPOSE LADDER	
FE4X3P	3.5 M MULTIPURPOSE LADDER WITH PLATFORM	

NEW TO OUR RANGE

LADDERS

LADDERS

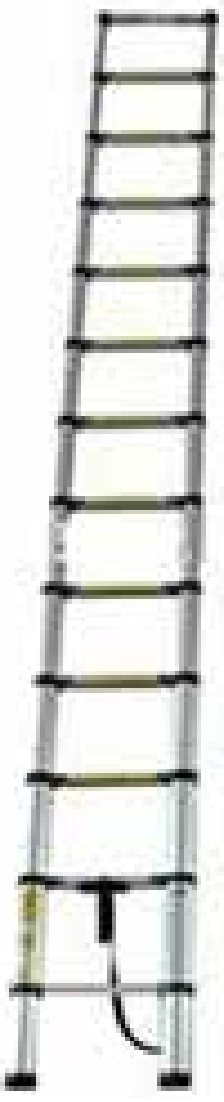

FREE CARRY BAG!

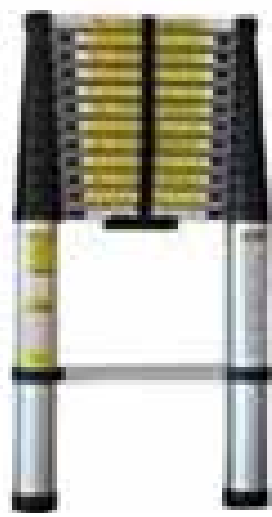

TELESCOPIC ALUMINIUM

- Extends to 3.8 metres
- Comes with a carry case
- ✓ Flexible to suit a variety of uses
- ✓ Max Load 150KG
- ✓ Weight 10kg
- ✓ Pack Qty : 4

TELESCOPIC ALUMINIUM LADDER 5MTR (16.4ft)

- ✓ Extends to 5 metres
- ✓ Comes with a carry case
- ✓ Flexible to suit a variety of uses
- ✓ Max Load 150KG
- ✓ Pack Qty : 4

TELESCOPIC ALUMINIUM LADDER

CODE	DESCRIPTION	PRICE
FE38	3.8MTR (13FT)	
FE50	5MTR (16.4FT)	



SITE SECURITY

DOMINATOR



SECURITY SITE BOX



NEW
ADD CASTOR
WHEELS X 4 SET
€30

**FORKLIFT
CHANNEL**

VANBOX:

- Substantial construction from 2mm Steel
- Anti-theft features includes anti-jemmy bars on the side and outside of the toolboxes 3mm and 5mm steel construction around the locks
- Twin strong hydraulic arms to assist with opening of the lid
- High security anti-drill locks
- All boxes are coded with 6keys
- Drop down handles one each end
- Available different powder coated finish, like as black, blue, yellow or red
- High security concealed split heavy duty piano hinge welded to box and lid
- Protective rubber tool mat

SECURITY SITE BOX

CODE	DESCRIPTION	PRICE
TB1D	940MM X 490MM X 450MM C/W 4KEYS	
TB2D	1310MM X 490MM X 450MM C/W 4KEYS	
TB2WHEELS	ADD 4 SET CASTOR WHEELS	

SITE SECURITY

SITE SECURITY



WELDING



WELDING RODS

CODE	SIZE	PACK	PK PRICE	PRICE (per ctn 6)
WR25	2.5 x 12 GAUGE RODS	3KG	€7.37	
WR32	3.2X 10 GAUGE RODS	3KG	€7.37	
WR40	4.0 X 8 GAUGE RODS	3KG	€7.37	



HEAD SHIELDS

CODE	SIZE	PACK
SE1005	HAND HELD SHIELD WITHOUT GLASS	
SE1006	FLIP UP HEAD SHIELD WITHOUT GLASS	
SE1009	4 1/4" X 3 1/4" CLEAR LENSE	
SE1010	4 1/4" X 3 1/4" SHADE/DARK LENSE	
SE1012	4 1/4" x 2" CLEAR LENSE	
SE1013	4 1/4" X 2" SHADE/DARK LENSE	



FRENCH CHALK

CODE	DESCRIPTION	PRICE
SE1015	FLAT FRENCH CHALK	

ELECTRODE HOLDER & CLAMP

CODE	DESCRIPTION	PRICE
SE1013	400AMP ELECTRODE HOLDER	



STEEL PAINT MARKER MARKEL

CODE	DESCRIPTION	PRICE
SPM	STEEL PAINT MARKER MARKEL WHITE	
SPMY	STEEL PAINT MARKER MAREKL YELLOW	

TOOLS



SAFELINE TOOL RANGE

MEASURING WHEEL

Code: **TL597**

Qty/Ctn: **2**

Stock No: 22707

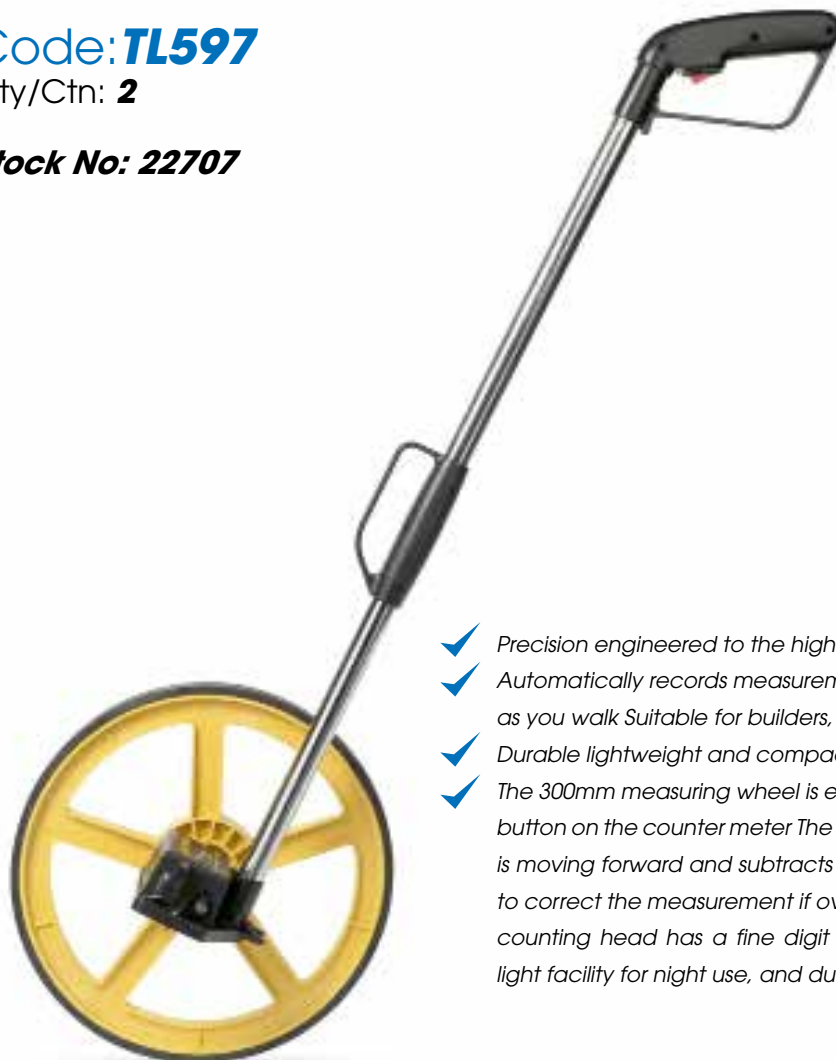

- ✓ Precision engineered to the highest quality One person operation
- ✓ Automatically records measurements as you walk Suitable for builders, farmers, road contractors etc
- ✓ Durable lightweight and compact
- ✓ The 300mm measuring wheel is easy to use - simply press the reset button on the counter meter The counter adds when the measurer is moving forward and subtracts in reverse Allowing the operator to correct the measurement if oversteps his mark The mechanical counting head has a fine digit read out Comes complete with light facility for night use, and durable canvas bag

40 MM - 4 CODE LOCK

Code: **TRI40**

QTY: **6PCS**



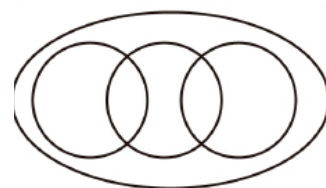

TRI-CIRCLE

SPEND €150 GET A FURTHER 5%
SPEND €250 GET AN EXTRA 7%
SPEND €350 GET AN EXTRA 10%

BLISTER PACKAGING

CODE	DESCRIPTION	PRICE
TRI21B	21MM TRICIRCLE BRASS PADLOCK BLISTER	
TRI25B	25MM TRICIRCLE BRASS PADLOCK BLISTER	
TRI32B	32MM TRICIRCLE BRASS PADLOCK BLISTER	
TRI38B	38MM TRICIRCLE BRASS PADLOCK BLISTER	
TRI50B	50MM TRICIRCLE BRASS PADLOCK BLISTER	
TRI63B	63MM TRICIRCLE BRASS PADLOCK BLISTER	

BOX PACKAGING

CODE	DESCRIPTION	PRICE
TRI21L	21MM TRICIRCLE BRASS PADLOCK NON BLISTER	
TRI25L	25MM TRICIRCLE BRASS PADLOCK NON BLISTER	
TRI32L	32MM TRICIRCLE BRASS PADLOCK NON BLISTER	
TRI38L	38MM TRICIRCLE BRASS PADLOCK NON BLISTER	
TRI50L	50MM TRICIRCLE BRASS PADLOCK NON BLISTER	
TRI63L	63MM TRICIRCLE BRASS PADLOCK NON BLISTER	

LONG SHACKLE

CODE	DESCRIPTION	PRICE
TRISHL38	38MM TRICIRCLE LONG SHACKLE NON BLISTER	
TRISHL50	50MM TRICIRCLE LONG SHACKLE NON BLISTER	

LONG SHACKLE BLISTER

CODE	DESCRIPTION	PRICE
TRISHB38	38MM TRICIRCLE LONG SHACKLE BLISTER	
TRISHB50	50MM TRICIRCLE LONG SHACKLE BLISTER	

HAND TRUCKS

HT1805

**COMFORT
& CONTROL**
HANDGRIPS

HT1893

STRONG
TUBULAR STEEL

**STEEL
CENTERED**
PNEUMATIC WHEELS

**FOLDS
UP & DOWN**

WIDTH (MM)	HEIGHT (MM)	LENGTH (MM)
550mm	1310mm	460mm

WIDTH (MM)	HEIGHT (MM)	LENGTH (MM)
670mm	1200mm	595mm



FOLDING HAND TRUCK

- SPONGE GRIP HANDLE
- LIGHT WEIGHT ALUMINIUM FRAME
- HOLDS 80KG

Code: **TL623**

Bx Qty: **6**



PROFESSIONAL HAND RIVET GUN

Code: **TL228**

PROFESSIONAL LAZY TONGS

Code: **TL227**



8X2X1 OIL STONES

Code: **TL223**

Combination oilstone made from Aluminium Oxide with one fine face and one coarse face. Can be used either dry or with a light oil.

Size: **8" x 2" x 1"**

Grade: **Fine / Coarse**





PIPE BENDER SUITABLE FOR 15 & 22MM PIPE

Suitable for 15 and 22mm outside diameter copper tube Complete with form wheel and guides, bends tube over 180° complete with cushion grip

Code: **TL329**

Size: **15 & 22mm**
Qty/Ctn: **4**



600mm CHROME PAINT MIXER

- Heavy duty chrome plated paint mixer ideal for stirring and mixing paint and other liquids.
- 6 sided hexagonal shaft
- Can be used with most power drills
- Approx size 600 x 120mm
- On hanging card

Code: **TLS3975**